

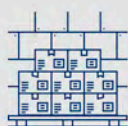

**TECNOLOGÍA,
CALIDAD
Y SOSTENIBILIDAD**
TECHNOLOGY, QUALITY & SUSTAINABILITY
TECHNOLOGIE, QUALITÉ ET DURABILITÉ

V.1.00
FEBRERO 2024

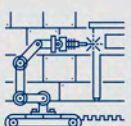
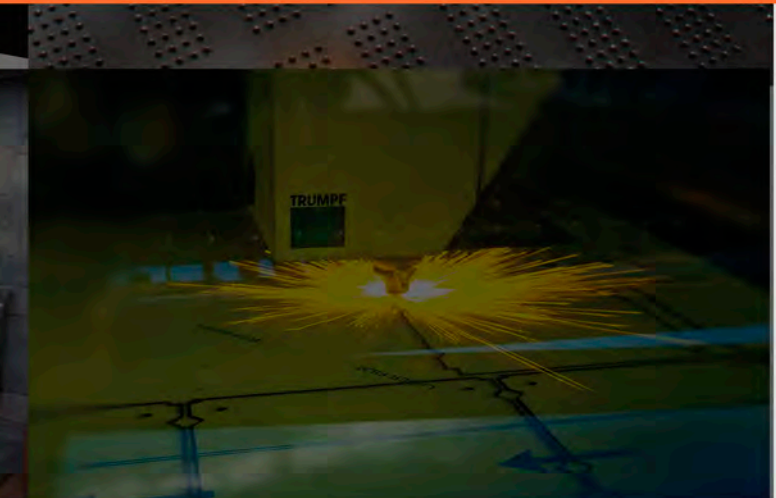
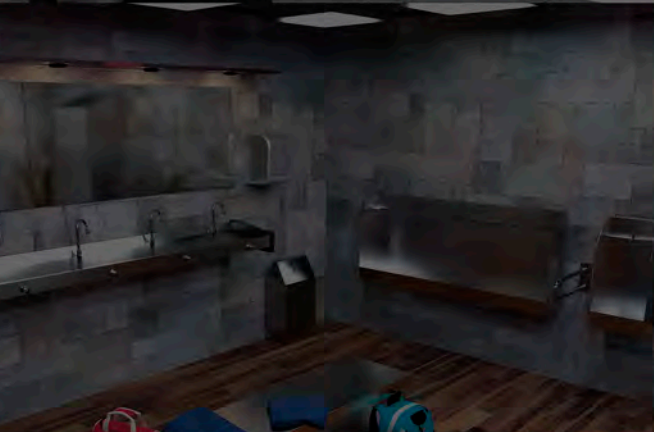

PROHIBIDA LA REPRODUCCIÓN TOTAL O PARCIAL DE ESTE CATÁLOGO

NOTA: La información que les facilitamos en este catálogo, tanto en precios, modelos, dimensiones y características, no nos obliga a mantenerlos y pueden ser modificados sin previo aviso.

Algunas de las imágenes mostradas en este catálogo han sido creadas digitalmente y pueden variar de la realidad.

NOTE: All the information in this catalogue, whether it be prices, models, dimensions or characteristics is subject to change without notice.

Some of the images shown in this catalogue were created digitally and can vary from reality.

NOTE: L'information que nous vous donnons dans ce catalogue relative aux prix, aux modèles, aux dimensions et aux caractéristiques ne nous oblige pas à maintenir ces derniers; c'est pourquoi, ils peuvent subir des modifications.

Certaines images montrées dans ce catalogue ont été créées numériquement et peuvent varier de la réalité.



La historia de FRICOSMOS, S.A. comenzó en el año 1985 representando la continuidad de una saga familiar cuyos orígenes se remontan a 1.960, año en el que se creó la empresa Inoxidables Sanz León que fabricaba productos de herraje y de cuchillería.

38 años después aquella empresa ha crecido, obteniendo el reconocimiento de más de 7.000 distribuidores en todo el mundo. Esta difícil andadura la hemos recorrido gracias a un equipo de profesionales que han creído en este proyecto empresarial, trabajando con ilusión, la ilusión que nos sigue impulsando a seguir creciendo y a responder con garantías los retos que plantea este nuevo contexto competitivo.

FRICOSMOS, S.A., en su larga tradición por la calidad obtuvo la certificación ISO 9001 en el año 2002, actualizada en este momento a la versión 2008. Este certificado es el reconocimiento de la madurez y eficacia de nuestro sistema de calidad y confirma la voluntad de la empresa de desarrollar una línea de progreso continuo, en la que dar cada día una respuesta más ajustada a las necesidades de nuestros clientes.

Durante todos estos años hemos unido nuestra tecnología de vanguardia a materiales de primera calidad, para obtener unos productos típicamente artesanos y de calidad garantizada, cumpliendo todos los estándares y normativas europeas aplicables. Todos nuestros productos se diseñan teniendo en cuenta los requisitos legales, lo que es de gran ayuda para sus clientes en la implantación de un Sistema de Gestión de Calidad Alimentaria APPCC (Análisis de Peligros y Puntos de Control Crítico), HACCP en terminología sajona.

Este catálogo se ha diseñado y realizado pensando en las necesidades de nuestros clientes; es por ello por lo que, en nuestro espíritu de mejora continua, estudiaremos cuantas sugerencias de mejora acerca del mismo podamos recibir, y así adecuarlo en próximas ediciones.



The story of Fricosmos began in the year 1985. It represents the continuity of a long dynasty which origins goes back to the year 1960, year when the firm Inoxidables Sanz León, was founded as an ironworks and knives manufacturing company.

38 years later the company has grown giving as a result a firm with the recognition of more than 7.000 distributors all over the world. This long progress has been achieved thanks to a team of professionals that believe in this business project, working together as a group with a will that encourages us to keep on growing and rising up our level within this so competitive context.

Fricosmos, S.A., continuing its long tradition of quality, obtained the certified ISO 9001 in the year 2002, now updated to its version 2008. This certified is the recognition to the efficiency and maturity of our quality system, and confirms the purpose of our firm for the development of a straight line of continuous progress, giving day after day the most suitable response to our customers' needs.

Throughout all these years we have combined our innovative technology and materials of the highest standards to obtain a typically handicraft product with a guaranteed quality that accomplishes all the norms of the European current regulations. Every one of our products is conceived in accordance to all legal requirements, so that they can be helpful for your customers when adopting the Food Quality Management System HACCP (Hazard Analysis and Critical Control Point).

This catalogue has been designed and carried out thinking on our customer demands. For this reason and true to our will of continuous improvement, we will study thoroughly every suggestion we receive concerning it for its adequacy to our clients' needs in next editions.



L'histoire de Fricosmos commença en 1985 et représente la continuité d'une longue dynastie familiale dont ses origines remontent à 1960. Cette date est l'année de création de l'entreprise Inoxidables Sanz León qui fabriquait de la ferrure et de la coutellerie.

38 ans après, cette société-là est grandie et a obtenu la reconnaissance de plus de 7.000 distributeurs tout autour du monde. Ce long chemin a été possible grâce à une équipe de professionnels qui ont cru à ce projet et qui travaillent ensemble avec une volonté qui nous encourage à continuer à croître et à répondre aux défis de ce nouveau contexte si compétitif.

Fricosmos, S.A. a obtenu la certification ISO 9001 en 2002, actualisée en ce moment à la version 2008. Ce certificat éprouve l'efficacité et l'expérience de notre système de qualité en confirme la volonté de la société pour développer une ligne de progrès constant et pour offrir chaque jour une réponse adaptée au maximum aux besoins de nos clients.

Au cours des années, nous avons allié une technologie d'avant-garde aux matériaux de première qualité afin d'obtenir des produits exclusivement artisanaux d'une qualité garantie qui respectent les réglementations européens applicables. Tous les produits de Fricosmos sont conçus pour respecter les exigences légales ce qui sera d'une grande utilité pour vos clients à développer le système de gestion de la qualité alimentaire HACCP (Hazard Analysis and Critical Control Point).

Pour concevoir et réaliser ce catalogue, nous avons pensé aux besoins de nos clients, c'est pour cela que, dans notre intention d'amélioration continue, nous étudierons toutes les suggestions que nous recevrons afin d'adapter au maximum ce catalogue à votre utilisation.



Calle Cámara de la Industria, 11A
Polígono industrial nº 1
28938 MÓSTOLES (Madrid) ESPAÑA
www.fricosmos.com



Capture el código desde su dispositivo móvil a través de su aplicación lectora de QR-Codes.

Capture the code from your mobile device through your reader application QR-Codes.

Capturez le code de votre appareil mobile via votre application lecteur de QR-Codes.

 +34 916 852 130

 +34 638 271 889



facebook.com/fricosmos



twitter.com/fricosmos



youtube.com/fricosmos



linkedin.com/company/fricosmos/



LEYENDA

SYMBOLS SYMBOLES

L H H1 Dimensiones en milímetros.
Dimensions in millimeters.
Dimensions en millimètres.

H2 H3 A

D D1 D2

E E1 E2

F I I1

h h1 h2

a a1 a2

d



Altura máxima en milímetros.
Maximum height in millimeters.
Hauteur maximale en millimètres.



Altura mínima en milímetros.
Minimum height in millimeters.
Hauteur minimale en millimètres.



Peso neto en kilogramos.
Net weight in kilograms.
Poids net en kilogrammes.



Peso neto en gramos.
Net weight in grams.
Poids net en grammes.



Código de producto.
Product Code.
Code de produit.



Colores disponibles.
Available colors.
Couleurs disponibles.



No son necesarias herramientas para el montaje del producto.
No tools required for assembly of the product.
Aucun outil requis pour l'assemblage du produit.



Diámetro en milímetros.
Diameter in millimeters.
Diamètre en millimètres.



Producto adaptado para lavavasos.
Product suitable for glasswashers.
Produit apte pour lave-verres.



Producto adaptado para lavaplatos.
Product suitable for dishwasher.
Produit apte pour lave-vaisselle.



Caudal de agua en litros por minuto.
Water flow rate in liters per minute.
Débit d'eau en litres par minute.



Temperatura máxima en grados centígrados.
Maximum temperature in degrees Celsius.
Température maximale en degrés Celsius.



Alcance máximo.
Maximum reach.
Portée maximum.



Capacidad en litros.
Capacity in liters.
Capacité en litres.



Peso máximo soportado.
Maximum load capacity.
Capacité de charge maximale.



Unidades contenidas en la caja o bolsa.
Units contained per box or bag.
Unités contenus par boîte ou sac.



Revoluciones por minuto.
Revolutions per minute.
Tours par minute.



Accesorio incluido en el producto.
Accessories included with the product.
Accessoires inclus avec le produit.



Accesorio no incluido en el producto.
Accessories not included with the product.
Accessoires non inclus avec le produit.



Número de soportes.
Number of supports.
Nombre de supports.



Orientación de desagüe.
Drain position.
Position d'égouttoir.



Número de huecos.
Number of holes.
Nombre de trous.



Número de puertas abatibles.
Number of hinged doors.
Nombre de portes battantes.



Número de puertas corredera.
Number of sliding doors.
Nombre de portes coulissantes.



Tipo de conexión eléctrica.
Type of electrical connection.
Type de connexion électrique.



Producto muy pesado.
Very heavy product.
Produit très lourd.



Normativa internacional Gastronorm.
Gastronorm international standards.
Norme internationale Gastronorm.



Producto adaptado en altura para cocinas serie snack o modular.
Product height adapted to modular or snack bar kitchens.
Hauteur du produit adapté aux cuisines modulaires ou de restauration rapide.



Preste especial atención.
Pay special attention.
Prêtez particulière attention.



Ampliar información en la página.
More information on page.
Plus d'informations à la page.



Únicamente los productos con este logotipo cumplen con la certificación NSF.
Only products with this logo meet NSF certification.
Seulement les produits avec ce logo sont conformes aux certifications NSF.



ESTANTERÍAS Y ESTANTES

SHELVING AND SHELVES
RAYONNAGES ET ÉTAGÈRES

7



HERRAJES

HOOKS AND STAINLESS STEEL FIXTURES
FERRURES ET CROCHETS

39



TAJOS DE TROCEO Y FIBRAS DE CORTE

CHOPPING BLOCKS AND FIBRE BOARDS
BILLOTS DE DÉCOUPAGE ET PLAQUES

67



CUCHILLERÍA PROFESIONAL

PROFESSIONAL KNIVES
COUTELLERIE PROFESIONNELLE

87



LAVAMANOS

WASHBASINS
LAVE-MAINS

179



FUENTES DE AGUA

DRINKING FOUNTAINS
SOURCES D'EAU

203



FREGADEROS

SINKS
ÉVIERS

215



GRIFERÍA

TAPS AND FITTINGS
ROBINETTERIE

241



MOBILIARIO

FURNITURE
MEUBLES

283



SEGURIDAD E HIGIENE

HEALTH AND SAFETY
SÉCURITÉ ET SANTÉ AU TRAVAIL

353



COMPLEMENTOS

COMPLEMENTS
COMPLÉMENTS

431



INDICE ANALITICO / CONDICIONES GENERALES

ANALYTICAL TABLE OF CONTENTS / GENERAL CONDITIONS
INDEX ANALYTIQUE / CONDITIONS GÉNÉRALES

501



ER-0332/2002



Fricosmos,S.A. contribuye a la conservación del Medio Ambiente mediante su aportación al sistema de separación, retirada y reciclado de nuestros envases con el sistema Ecoembes identificado con el punto verde.

Fricosmos, S.A. contributes to the preservation of the environment through its contribution to the procedure of selection, removal and recycling of our packages following the Ecoembes system identified with the green point.

Fricosmos, S.A. participe de la préservation de l'environnement moyennant sa contribution au procédé de sélection, retirée et recyclage de nos emballages selon le système Ecoembes identifié avec le point vert.



Registro sanitario
nº 39.2737 / M





ESTANTERIAS Y ESTANTES

SHELVING AND SHELVES

RAYONNAGES ET ÉTAGÈRES

NOVEDADES
NEWS
NOUVEAUTÉS



19



19

Estanterías modulares

Modular shelving
Rayonnages modulaires

Características de fabricación:

Construidas totalmente en acero inoxidable, acabado satinado.
Doble pliegue con pestaña aplastada en los estantes, para evitar cortes y ganar resistencia.
Fácil montaje.
Gran diversidad de medidas para una máxima adaptación a su lugar de colocación.
Alturas disponibles desde 850 mm, para su utilización como mesas de apoyo, carros, etc., hasta 2950 mm para el mejor aprovechamiento del espacio.
Dos espesores de chapa disponibles y con la opción de poder solicitarlas con refuerzos soldados en su base, ver página 11.
Se puede regular la altura entre estante y estante cada 100 mm, con posibilidad de poner un estante a ras de suelo.
Pies regulables para una mayor estabilidad en cualquier suelo.
Posibilidad de colocación de ruedas, ver página 497.
Opcionalmente se pueden suministrar con kit de pletinas. Ver página 11.

Manufacturing characteristics:

Made totally in stainless steel shiny finished.
Double fold with crushed fringe in shelves, to avoid any bad cut and to increase the resistance.
Easy mounting.
Great diversity of measures to allow a maximum fitting to the mounting room.
Available heights from 850 mm for its usage as auxiliar tables, charts, etc. up to 2950 mm for the best use of the room.
Sheet thick available in two measures with the option of order them with reinforcements fixed at its base. See page 11.
Height adjustment every 100 mm, with the possibility of mounting one shelf at the ground level.
Adjustable feet to allow a higher stability on any floor.
Possibility of fixing wheels. See page 497.
They can be supplied optionally with plates and hooks. See page 11.

Caractéristiques de fabrication:

Construit totalement en acier inoxydable finition satinée. Double pli avec rebord aplati pour éviter des coupures et gagner en résistance.
Facilité de montage.
Grand diversité de mesures pour une maxime adaptation a l'endroit de installation.
Hauteur disponibles depuis 850 mm pour l'utilisation comme tables auxiliaires, chariots, etc, jusqu'à 2950 mm pour le mieux profit de l'espace.
Deux épaisseurs de tôle disponibles avec l'option de les solliciter avec renforcements soudés dans sa base. Voir page 11.
Hauteur réglable tous les 100 mm, avec la possibilité de monter une étagère au niveau du sol.
Pieds réglables pour une plus grande stabilité dans n'importe quel sol.
Possibilité de montage de rouelles. Voir page 497.
Optionnellement elles peuvent être fournies avec un kit de platines et crochets. Voir page 11.



Detalle de kit de pletinas acoplado a estantería.
Detail of plates set coupled in shelving.
Détail de kit de pletines accouplé dans le rayonnage.



Posibilidad de acoplar cajones a estantes.
Drawer coupled possibility.
Possibilité de tiroir acouplé.

493

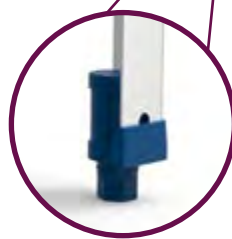

Detalle del pie del soporte de estantería.
Detail of shelving support base.
Détail du pied du support de rayonnage.



Posibilidad de acoplar ruedas a soportes de estantería.
Castor fixed to shelving supports possibility.
Possibilité de rouelle acouplée dans supports de rayonnage.

Estanterías modulares con estantes lisos

Modular shelving with non-perforated shelves
Rayonnages modulaires avec étagères lisses

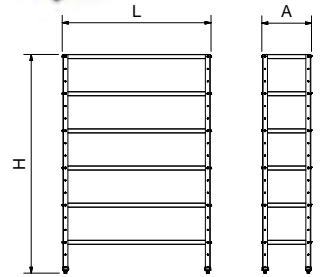

Estos precios incluyen estantes, soportes, tornillos y tuercas.
Shelves, shelving supports, nuts and bolts included in these prices.
Étagères, supports de rayonnage et vis à écrou compris dans ces prix.

				Número de estantes Number of shelves Numéro d'étagères							
				3		4		5		6	
L	A	H	Estante de Strength per Étagère par	Barcode	€	Barcode	€	Barcode	€	Barcode	€
800	300	1.750	0,8 mm	910060402	241,68	910060302	278,24	910060202	314,80	910060102	351,36
			1,5 mm	910060902	289,68	910060602	342,24	910060702	394,80	910060802	447,36
1.000	300	1.750	0,8 mm	910060404	253,68	910060304	294,24	910060204	334,80	910060104	375,36
			1,5 mm	910060904	334,68	910060604	402,24	910060704	469,80	910060804	537,36
1.200	300	1.750	0,8 mm	910060406	277,68	910060306	326,24	910060206	374,80	910060106	423,36
			1,5 mm	910060906	373,68	910060606	454,24	910060706	534,80	910060806	615,36
1.400	300	1.750	0,8 mm	910060408	295,68	910060308	350,24	910060208	404,80	910060108	459,36
			1,5 mm	910060908	412,68	910060608	506,24	910060708	599,80	910060808	693,36
800	400	1.750	0,8 mm	910060410	253,68	910060310	294,24	910060210	334,80	910060110	375,36
			1,5 mm	910060910	337,68	910060610	406,24	910060710	474,80	910060810	543,36
1.000	400	1.750	0,8 mm	910060412	277,68	910060312	326,24	910060212	374,80	910060112	423,36
			1,5 mm	910060912	376,68	910060612	458,24	910060712	539,80	910060812	621,36
1.200	400	1.750	0,8 mm	910060414	295,68	910060314	350,24	910060214	404,80	910060114	459,36
			1,5 mm	910060914	415,68	910060614	510,24	910060714	604,80	910060814	699,36
1.400	400	1.750	0,8 mm	910060416	325,68	910060316	390,24	910060216	454,80	910060116	519,36
			1,5 mm	910060916	460,68	910060616	570,24	910060716	679,80	910060816	789,36
800	500	1.750	0,8 mm	910060418	277,68	910060318	326,24	910060218	374,80	910060118	423,36
			1,5 mm	910060918	376,68	910060618	458,24	910060718	539,80	910060818	621,36
1.000	500	1.750	0,8 mm	910060420	295,68	910060320	350,24	910060220	404,80	910060120	459,36
			1,5 mm	910060920	415,68	910060620	510,24	910060720	604,80	910060820	699,36
1.200	500	1.750	0,8 mm	910060422	325,68	910060322	390,24	910060222	454,80	910060122	519,36
			1,5 mm	910060922	460,68	910060622	570,24	910060722	679,80	910060822	789,36
1.400	500	1.750	0,8 mm	910060424	343,68	910060324	414,24	910060224	484,80	910060124	555,36
			1,5 mm	910060924	505,68	910060624	630,24	910060724	754,80	910060824	879,36
800	600	1.750	0,8 mm	910060426	295,68	910060326	350,24	910060226	404,80	910060126	459,36
			1,5 mm	910060926	415,68	910060626	510,24	910060726	604,80	910060826	699,36
1.000	600	1.750	0,8 mm	910060428	325,68	910060328	390,24	910060228	454,80	910060128	519,36
			1,5 mm	910060928	460,68	910060628	570,24	910060728	679,80	910060828	789,36
1.200	600	1.750	0,8 mm	910060430	343,68	910060330	414,24	910060230	484,80	910060130	555,36
			1,5 mm	910060930	505,68	910060630	630,24	910060730	754,80	910060830	879,36
1.400	600	1.750	0,8 mm	910060432	394,68	910060332	482,24	910060232	569,80	910060132	657,36
			1,5 mm	910060932	541,68	910060632	678,24	910060732	814,80	910060832	951,36

Estantes lisos para estanterías modulares

Flat shelves for modular shelving
Étagères lisses pour rayonnages modulaires

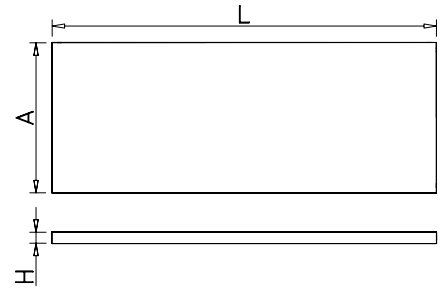

			Estantes de 0,8 mm 0,8 mm shelves Étagères 0,8 mm			Estantes de 1,5 mm 1,5 mm shelves Étagères 1,5 mm		
L	A	H	Kg	Barcode	€	Kg	Barcode	€
800	300	35	2,20	010202	34,00	4,16	010402	50,00
1.000	300	35	2,78	010204	38,00	5,14	010404	65,00
1.200	300	35	3,24	010206	46,00	6,02	010406	78,00
1.400	300	35	3,76	010208	52,00	7,02	010408	91,00
800	400	35	2,76	010210	38,00	5,32	010410	66,00
1.000	400	35	3,40	010212	46,00	6,30	010412	79,00
1.200	400	35	4,04	010214	52,00	7,71	010414	92,00
1.400	400	35	4,76	010216	62,00	9,00	010416	107,00
800	500	35	3,36	010218	46,00	6,16	010418	79,00
1.000	500	35	4,14	010220	52,00	7,68	010420	92,00
1.200	500	35	4,90	010222	62,00	9,12	010422	107,00
1.400	500	35	5,56	010224	68,00	10,58	010424	122,00
800	600	35	3,86	010226	52,00	7,30	010426	92,00
1.000	600	35	4,94	010228	62,00	8,98	010428	107,00
1.200	600	35	5,60	010230	68,00	10,70	010430	122,00
1.400	600	35	6,50	010232	85,00	12,34	010432	134,00

Soportes de estantería

Shelving supports
Supports de rayonnage



Características:

Espesor del acero 2 mm.
Admiten estante a nivel del suelo.
Separación entre taladros de 100 mm.

Characteristics:

Stainless steel thickness 2 mm.
Shelf allowed at ground level.
Holes are 100 mm apart.

Caractéristiques:

Acier inoxydable épaisseur 2 mm.
Étagère admise au niveau du sol.
Écart des trous tous les 100 mm.

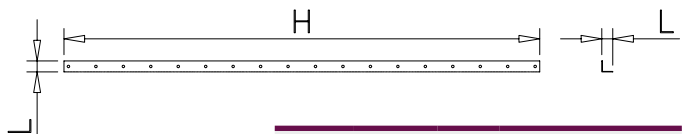

H	L	Kg	Barcode	€
850	40x40	1,05	011002	21,00
1.050	40x40	1,24	011004	22,00
1.450	40x40	1,62	011006	31,00
1.750	40x40	2,02	011008	33,00
2.050	40x40	2,38	011010	36,00
2.350	40x40	2,58	011012	46,00
2.950	40x40	2,69	011014	58,00

Refuerzos soldados a estantes

Welded reinforcements for shelves
Renforts soudés aux étagères



Características:

Aumentan la capacidad de carga. Ver página 12

Characteristics:
Increase the load-capacity. See the page 12

Caractéristiques:
Il sert à améliorer la capacité de chargement. Voir page 12

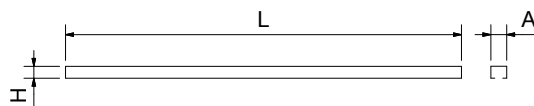

L	A	H	Kg	Barcode	€
800	40	30	1,02	011202	20,00
1.000	40	30	1,18	011204	25,00
1.200	40	30	1,41	011206	27,00
1.400	40	30	1,65	011208	29,00

Tornillos y tuercas para estantes

Nut and bolt for shelves
Vis à écrou pour étagères

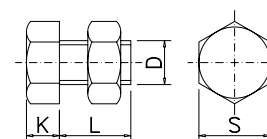

Tornillo para unión de estanterías.

Screw for shelving units union.
Vis pour union d'étagères.

8 tornillos y tuercas por estante.
8 nut and bolt for shelf.
8 vis et écroux pour étagère.

	D	L	S	K	Gr	Barcode	€
Tornillo Bolt Vis	M8	12	13	5,3	7,00	421012	0,20
Tornillo Bolt Vis	M8	25	13	5,3	11,00	421016	0,25 *
Tuerca Nut Écrou	M8		13	5,3	4,00	421056	0,12

Kit de pletinas para estanterías

Plate kit for shelves
Kit de platines pour rayonnages



Dotación de cada kit de pletinas:

Una pletina de la medida del largo de la estantería, con una "U" soldada a cada extremo. Dos pletinas de la medida del ancho de la estantería preparadas para atornillar a los soportes. Tornillería.

Each plate kit consists of:
One plate of the same length as the shelves with a U-shaped bracket welded to either end. Two plates of the same width as the shelves ready to be bolted to the supports. Nuts and bolts.

Dotation de chaque kit de platines:
Une platine mesurant la largeur de l'étagère avec deux "U" soudés à chaque extrémité. Deux platines mesurant la largeur de l'étagère conçues pour être vissées aux supports. Visserie.

L	A	Kit 1 Pletina One plate kit Kit de 1 platine		Pletina Opcional Optional plate Platine en option	
		Barcode	€	Barcode	€
800	300	012802	163,00	012850	78,00
	400	012810	177,00		
	500	012818	190,00		
	600	012826	203,00		
1.000	300	012804	173,00	012852	87,00
	400	012812	190,00		
	500	012820	203,00		
1.200	600	012828	214,00	012854	96,00
	300	012806	186,00		
	400	012814	203,00		
	500	012822	214,00		
1.400	600	012830	224,00	012856	105,00
	300	012808	198,00		
	400	012816	214,00		
	500	012824	225,00		
	600	012832	236,00		

Resistencia de carga por estante

Load strength

Résistance de charge par étagère



Las cargas se consideran uniformemente repartidas en la superficie del estante.

It is assumed that loads are evenly distributed on the shelf surface.
On considère que les charges sont réparties uniformément sur la surface de l'étagère.

Dimensiones Dimensions Dimensions	Estante de Strength per Étagère par	Sin refuerzos Without reinforcement Sans renforts	1 refuerzo 1 reinforcement 1 Renforts	2 refuerzos 2 reinforcement 2 Renforts	3 refuerzos 3 reinforcement 3 Renforts
800x300	0,8 mm	225	275	325	
	1,5 mm	300	350	400	
1.000x300	0,8 mm	175	225	275	
	1,5 mm	250	300	375	
1.200x300	0,8 mm	125	150	200	
	1,5 mm	150	200	275	
1.400x300	0,8 mm	100	125	175	
	1,5 mm	125	175	225	
800x400	0,8 mm	200	250	300	350
	1,5 mm	275	325	375	475
1.000x400	0,8 mm	150	200	250	300
	1,5 mm	225	275	350	450
1.200x400	0,8 mm	100	125	175	225
	1,5 mm	125	175	250	350
1.400x400	0,8 mm	75	100	150	200
	1,5 mm	100	150	200	300
800x500	0,8 mm	200	250	300	350
	1,5 mm	275	325	375	475
1.000x500	0,8 mm	150	200	250	300
	1,5 mm	225	275	350	450
1.200x500	0,8 mm	100	125	175	225
	1,5 mm	125	175	250	350
1.400x500	0,8 mm	75	100	150	200
	1,5 mm	100	150	200	300
800x600	0,8 mm	175	225	275	325
	1,5 mm	250	300	350	450
1.000x600	0,8 mm	125	175	225	275
	1,5 mm	200	250	325	425
1.200x600	0,8 mm	75	100	150	200
	1,5 mm	100	150	225	325
1.400x600	0,8 mm	50	75	125	175
	1,5 mm	75	125	175	275

Soporte de sobremesa y mural porta-cubetas Gastronorm

Worktop and wall fixed Gastronorm trays holder
Support sur table et mural porte-cuveaux Gastronorm



Characteristics:

Manufactured in stainless steel.
For worktop or wall mounted use (screws included).
It can lodge Gastronorm containers up to 200 mm depth.
You can carry out numerous combinations depending on your needs by using the dividing sections.
Gastronorm containers and dividing sections not included.
Lids and containers, see page 435.
Dividing sections, see page 444.
Standard handle for Gastronorm containers, see page 446.

Caractéristiques:

Fabriqué en acier inoxydable.
Il est conçu à poser sur table ou à accrocher au mur.
Il peut loger des bacs Gastronorm jusqu'à 200 mm de profondeur.
Vous pouvez réaliser des combinaisons nombreuses selon vos besoins en utilisant les sections de séparation.
Bacs GN et des sections de séparation n'ont pas inclus.
Couvercles et les récipients, voir page 435.
Sections de séparation, voir page 444.
Poignée standard pour récipients Gastronorm, voir page 446.

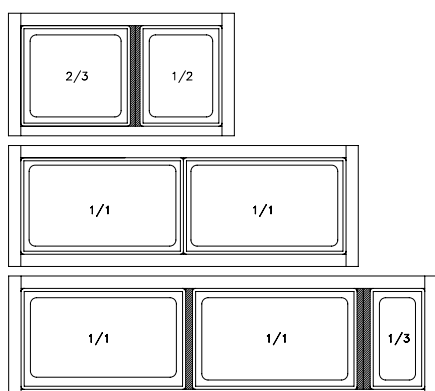

Características:

Fabricado en acero inoxidable.
Para uso de sobremesa o fijación mural (incluye tornillos para su fijación a la pared).
Admite cubetas de hasta 200 mm de profundidad.
Empleando los perfiles divisorios podrá ubicar numerosas combinaciones según sus necesidades.
No incluye las cubetas ni los perfiles.
Cubetas y tapas. Ver página 435.
Perfiles divisorios. Ver página 444.
Asa universal para cubetas. Ver página 446.

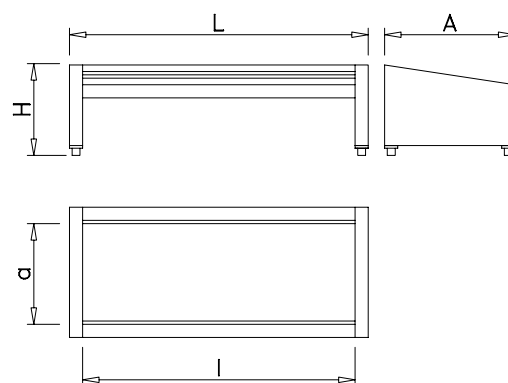

L	A	H	l	a	Kg	Barcode	€
740	390	275	655	325	6,0	082803	169,00
1.150	390	275	1.065	325	7,5	082804	180,00
1.390	390	275	1.305	325	8,5	082806	212,00

Estantes murales cartelas modelo compacto

Fixed wall shelves
Étagères murales modèle compact



Characteristics:
The main characteristic of these shelves is that they are made in one only piece.

These shelves generally use our bolt code 421034 and our plug code 409824. See page 63.

Caractéristiques:
La principale caractéristique de ces étagères est qu'elles sont fabriquées d'une seule pièce, dossier et postérieur.

Généralement, cet étagères utilisent notre vis code 421034 et notre cheville code 409824. Voir page 63.

Características:

La principal característica de estos estantes es su construcción en una sola pieza.

Estos estantes se suelen atornillar a la pared con nuestro tornillo cód. 421034 y con el taco cód. 409824. Ver página 63.

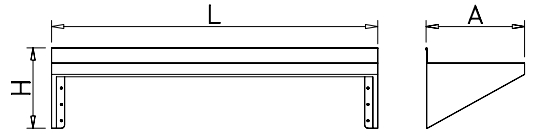

L	A	H	Kg	Barcode	€
1.000	300	245	5,76	011402	118,00
1.250	300	245	6,92	011404	129,00
1.500	300	245	8,08	011406	163,00
1.000	400	245	7,27	011408	141,00
1.250	400	245	8,73	011410	171,00
1.500	400	245	10,19	011412	189,00
1.000	500	245	8,78	011414	166,00
1.250	500	245	10,54	011416	190,00
1.500	500	245	12,30	011418	213,00



Tornillos y tacos no incluidos en el precio.
Bolts and plugs not included in the price.
Les vises et les chevilles ne sont pas inclus dans le prix.



Estantes murales de tubo

Tube wall shelves
Étagères murales en tube



These shelves generally use our bolt code 421034 and our plug code 409824. See page 63.

Généralement, cet étagères utilisent notre vis code 421034 et notre cheville code 409824. Voir page 63.

Estos estantes se suelen atornillar a la pared con nuestro tornillo cód. 421034 y con el taco cód. 409824. Ver página 63.

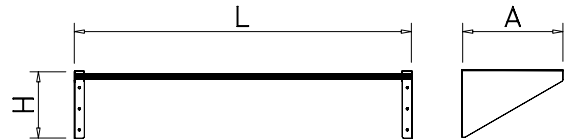

L	A	H	Kg	Barcode	€
750	300	200	4,00	011902	113,00
1.000	300	200	4,11	011904	119,00
750	400	200	4,80	011906	126,00
1.000	400	200	5,65	011908	130,00
750	500	200	5,88	011910	158,00
1.000	500	200	6,93	011912	169,00



Tornillos y tacos no incluidos en el precio.
Bolts and plugs not included in the price.
Les vises et les chevilles ne sont pas inclus dans le prix.

Estante mural especial microondas

Wall shelf - specially for microwaves
Étagère murale spéciale micro - ondes

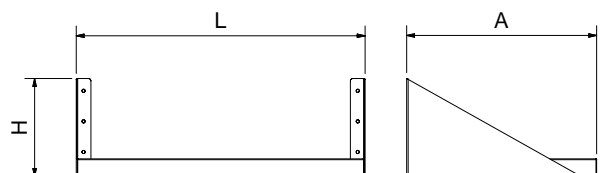

L	A	H	Kg	Barcode	€
590	388	200	3,00	015202	102,00



Tornillos y tacos no incluidos en el precio.
Bolts and plugs not included in the price.
Les vises et les chevilles ne sont pas inclus dans le prix.

Estantes murales regulables imagine

Imagine adjustable wall shelves
Étagères murales réglables imagine



Basados en las medidas internacionales GASTRONORM. Podrá intercambiar los estantes por recipientes, parrillas y fibras GN.

Based in the international standard GASTRONORM. You can replace the shelves for Gastronorm containers, grills and GN fibres.

Basé dans le standard international GASTRONORM. Vous pouvez remplacer les étagères pour les bacs, grilles GN et plaques GN.

Se instala con facilidad y rapidez. Los estantes se regulan a la altura deseada SIN HERRAMIENTAS, incluso su inclinación, 90° y 105°.

It can be mounted easily and quickly. Height and lean adjustment according to your needs WITHOUT TOOLS, 90° y 105°.

Installation facile et rapide. Réglage en hauteur et inclinaison selon vos besoins SANS OUTILS, 90° y 105°.

Ejemplos de configuraciones:

Examples of configurations:
Exemples de configurations:

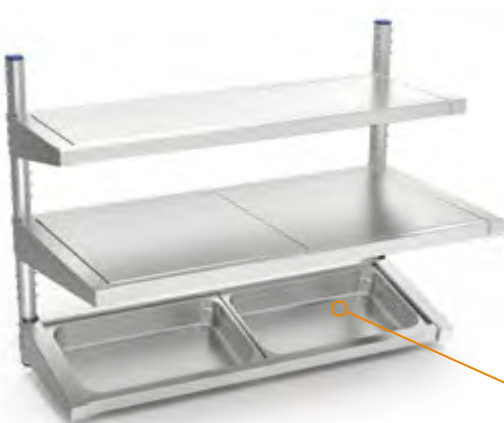
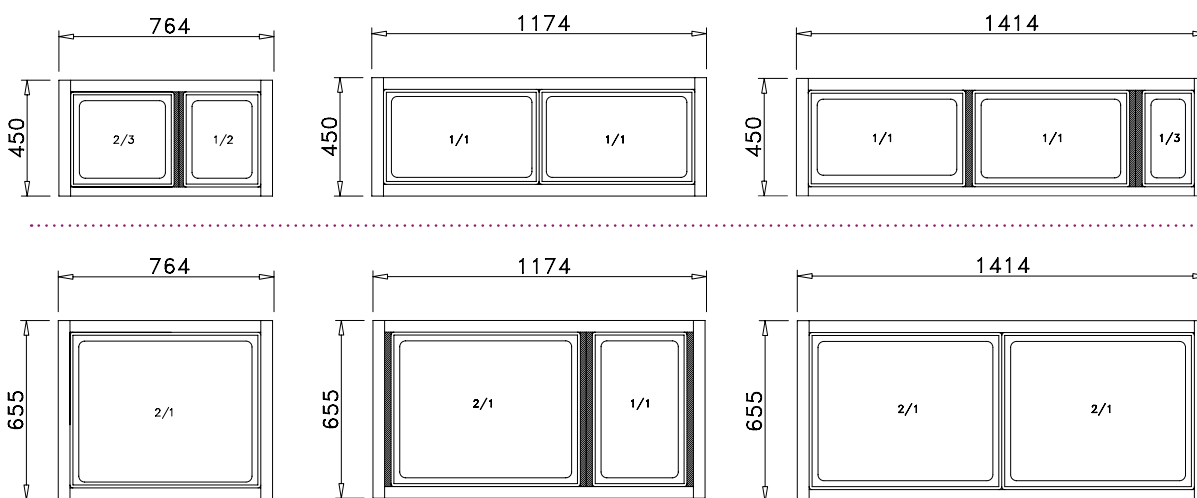

435

Cubetas Gastronorm.
Gastronorm trays.
Cuveau gastronorm.

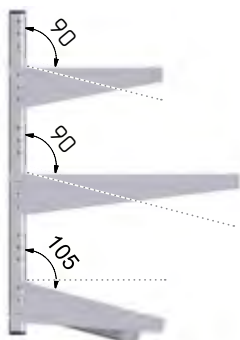
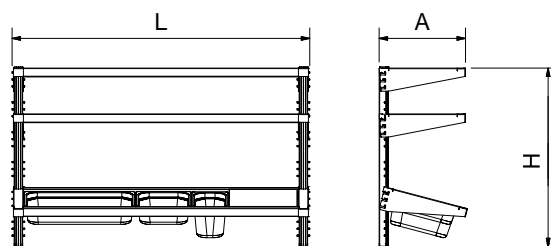

L	A	H	Barcode	€	Barcode	€	Barcode	€
764	413	860	910040102	264,00	910040202	400,00	910040302	536,00
1.174	413	860	910040104	292,00	910040204	456,00	910040304	620,00
1.414	413	860	910040106	330,00	910040206	532,00	910040306	734,00
764	614	860	910040108	286,00	910040208	444,00	910040308	602,00
1.174	614	860	910040110	324,00	910040210	520,00	910040310	716,00
1.414	614	860	910040112	362,00	910040212	596,00	910040312	830,00

Estantes murales con cartelas

Wall shelves with brackets
Étagères murales avec équères



Vuelta
Reverse bracket
Équèrres renversée



Estos estantes se suelen atornillar a la pared con nuestro tornillo cód. 421034 y con el taco cód. 409824. Ver página 63.

These shelves generally use our bolt code 421034 and our plug code 409824. See page 63.

Généralement, ces étagères utilisent notre vis code 421034 et notre chevillé code 409824. Voir page 63.



Tornillos y tacos no incluidos en el precio.

Bolts and plugs not included in the price.
Les vises et les chevilles ne sont pas inclus dans le prix.

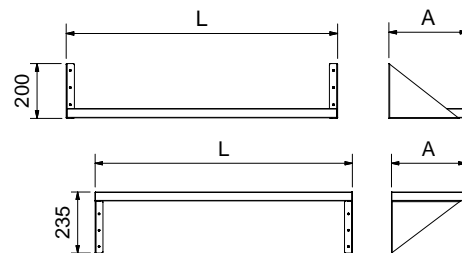

L	A			€
800	300	910080102	910080202	89,00
1.000	300	910080104	910080204	96,00
1.200	300	910080106	910080206	102,00
1.400	300	910080108	910080208	111,00
600	400	910080109	910080209	102,00
800	400	910080110	910080210	103,00
1.000	400	910080112	910080212	111,00
1.200	400	910080114	910080214	118,00
1.400	400	910080116	910080216	121,00
800	500	910080118	910080218	127,00
1.000	500	910080120	910080220	133,00
1.200	500	910080122	910080222	141,00
1.400	500	910080124	910080224	145,00
800	600	910080126	910080226	144,00
1.000	600	910080128	910080228	147,00
1.200	600	910080130	910080230	157,00
1.400	600	910080132	910080232	160,00

Estantes murales

Wall shelves
Étagères murales

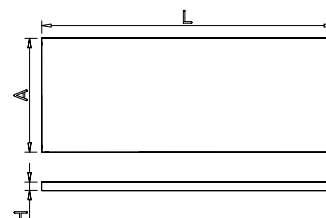

L	A	H	Kg		€
800	300	35	2,20	011602	55,00
1.000	300	35	2,78	011604	62,00
1.200	300	35	3,24	011606	68,00
1.400	300	35	3,76	011608	77,00
600	400	35	2,50	011609	64,00
800	400	35	2,76	011610	65,00
1.000	400	35	3,40	011612	73,00
1.200	400	35	4,04	011614	80,00
1.400	400	35	4,76	011616	83,00
800	500	35	3,36	011618	81,00
1.000	500	35	4,14	011620	87,00
1.200	500	35	4,90	011622	95,00
1.400	500	35	5,56	011624	99,00
800	600	35	3,95	011626	98,00
1.000	600	35	4,85	011628	101,00
1.200	600	35	5,75	011630	111,00
1.400	600	35	6,65	011632	114,00

Cartelas para estantes murales

Brackets for wall shelves
Équerres pour étagères murales

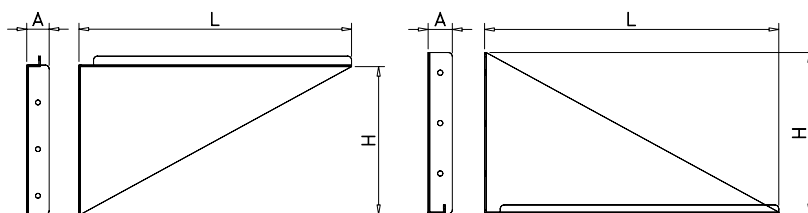
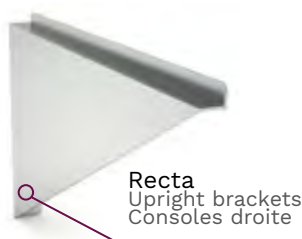

L	A	H	Gr	Barcode 1	Barcode 2	Barcode 3	Barcode 4	€
265	20	200	500	012402	012403	012602	012603	17,00
365	20	200	700	012404	012405	012604	012605	19,00
465	20	200	850	012406	012407	012606	012607	23,00

Estantes de suelo

Floor shelves
Étagères au sol

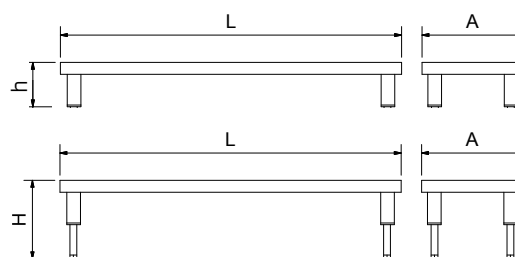
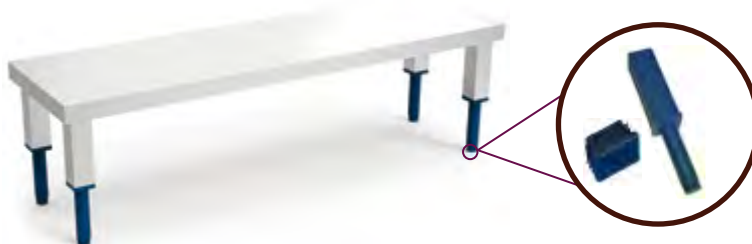

Diseñados para lugares donde no se permite el almacenamiento directamente en el suelo.

También válidos para mejorar la exposición de las carnes y embutidos dentro de los mostradores frigoríficos estándar. Su diversidad de medidas facilitan su adaptación a cualquier modelo de expositor. Construidos en chapa de acero inoxidable que, además de garantizar al máximo su duración, es totalmente higiénico y favorece la distribución del frío. Provistos de pies regulables en altura.

Intended for places where storage directly on the floor is not allowed.

Also valid for improve the display of meat and sausage on the stands of standar fridges. Its diversity of sizes make easier the adaptation at any model of stand. Constructed in stainless steel sheet that guarantees the maximum lenght and furthermore favours the cold distribution.

Fabriquées pour les lieux où le stockage directement au sol n'est pas permis.

Valables également pour améliorer l'exposition des viandes et des charcuteries dans les comptoirs frigorifiques standard. Sa diversité de dimensions facilitent sa adaptation a quelque modèle de comptoir. Construit en plaque d'acier inoxydable, laquel en plus de garantir au maximum sa durée, c'est totalement hygiénique et favorise la distribution du froid. Pourvu de pieds réglables en hauteur.

L	A	H	H1	Kg	Barcode	€
800	300	130	230	2,8	082002	148,00
1.000	300	130	230	3,4	082004	154,00
1.200	300	130	230	3,9	082006	160,00
1.400	300	130	230	4,4	082008	175,00
600	400	130	230	2,8	082018	114,00
800	400	130	230	3,4	082010	160,00
1.000	400	130	230	4,0	082012	171,00
1.200	400	130	230	4,7	082014	175,00
1.400	400	130	230	5,4	082016	196,00

Estante mural porta-barquetas

Wall shelf for meat plastic trays
Étagère murale porte-barquettes alimentaires

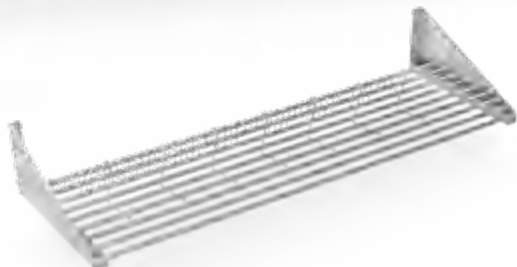
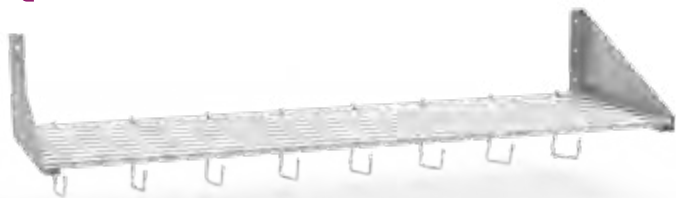

Estos estantes se suelen atornillar a la pared con nuestro tornillo cód. 421034 y con el taco cód. 409824. Ver página 63.

These shelves generally use our bolt code 421034 and our plug code 409824. See page 63.

Généralement, cet étagères utilisent notre vis code 421034 et notre cheville code 409824. Voir page 63.



Tornillos y tacos no incluidos en el precio.
Bolts and plugs not included in the price.
Les visés et les chevilles ne sont pas inclus dans le prix.

L	A	H	Nº Ganchos Hooks Crochets	Kg	Barcode	€
1.200	400	310	8	6,80	011920	179,00

Estante mural de fibra abatible

Polyethylene hinged wall shelf
Console murale battante en polyéthylène



Estos estantes se suelen atornillar a la pared con nuestro tornillo cód. 421034 y con el taco cód. 409824. Ver página 63.

These shelves generally use our bolt code 421034 and our plug code 409824. See page 63.



Généralement, cet étagères utilisent notre vis code 421034 et notre cheville code 409824. Voir page 63.

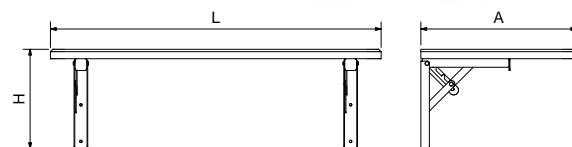

Tornillos y tacos no incluidos en el precio.
Bolts and plugs not included in the price.
Les visés et les chevilles ne sont pas inclus dans le prix.

L	A	H	Kg	Barcode	€
700	330	205	2,00	013206	190,00€

Estante mural inclinado para cestas de lavavajillas

Sloping wall rack shelf
Étagère murale inclinée pour paniers de lavage

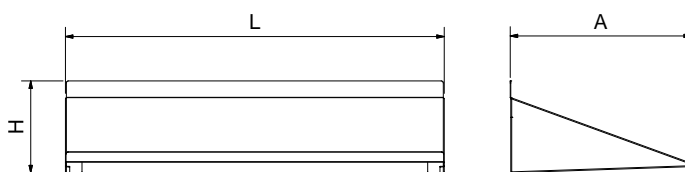

L	A	H	Barcode	Kg	Barcode	€
1.020	488	248	500x500	8,70	011430	185,00
1.550	488	248	500x500	12,50	011432	268,00

Taburete rodante profesional en acero inoxidable

Sloping wall rack shelf
Étagère murale inclinée pour paniers de lavage



Características:

Construido totalmente en acero inoxidable, este taburete profesional móvil de 2 peldaños garantiza a los usuarios una superficie robusta, estable y segura donde alzarse.

Dispone de 3 ruedas retráctiles para un cómodo desplazamiento mientras no está en uso, mientras que cuando el usuario lo utiliza, éste se adhiere al suelo con firmeza para evitar movimientos no deseados.

Gracias a estar fabricado en acero inoxidable, a diferencia de los taburetes del mercado, nuestro taburete es ideal para su utilización en ambientes hostiles, como industria alimentaria en general, industria cárnica, salas frías, salas de despiece, obradores, laboratorios... En resumen, cualquier estancia que precise una higiene rigurosa ya que es fácil de limpiar y desinfectar, incluso con hidrolimpiadora.

Characteristics:

This professional two steps stainless steel kick stool guarantees to users a robust, stable and safe surface to step onto.

It is supplied with three retractable wheels for easy moving while not in use, whereas it adheres firmly to the ground to prevent unwanted movements when in use.

Made in of stainless steel and thus especially recommended for general food industry (meat industry, cold rooms, laboratories...) or elsewhere with strict hygiene is required, by contrast to most of the step stools on the market.

Caractéristiques:

Fabriqué en acier inoxydable, ce tabouret professionnel mobile à 2 marches garantit aux utilisateurs une surface robuste, stable et sûre où monter.

Il dispose de 3 roues rétractables pour un déplacement confortable, lorsqu'il n'est pas utilisé, tandis que lorsque on l'utilise, il adhère fermement au sol pour éviter tout mouvement indésirable.

Grâce à sa fabrication en acier inoxydable, contrairement à d'autres modèles sur le marché, notre tabouret est idéal pour une utilisation dans l'industrie alimentaire en général, industrie de la viande, chambres froides, laboratoires... Bref, toute pièce nécessitant une hygiène rigoureuse.

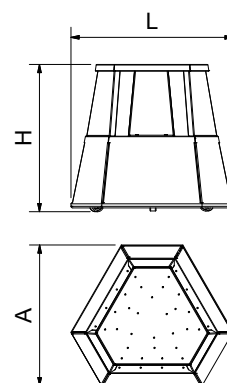

L	A	H	Kg	Barcode	€
479	416	435	5,50	082220	220,00

Taburete con ruedas

Rolling step-stool
Tabouret marche - pied roulant



Barcode €
482250 5,80

Rueda de repuesto para taburetes.
Spare wheel for step-stools.
Rouelle de rechange pour tabouretes.



Características:

Este taburete metálico lleva en su base tres ruedas que permiten su fácil traslado de un sitio a otro con un simple empujón del pie. Sin embargo, en el momento en que usted sube sobre él queda totalmente fijado al suelo gracias a su burlete circular que se adhiere como una ventosa.

Characteristics:

This metallic stool has on its base three castors that allow moving it from one place to another easily, just pushing it with your foot. Furthermore, whenever you are standing on it, it is firmly fixed to the floor, as if it were a suction pad, thanks to its rounded rubber strip.

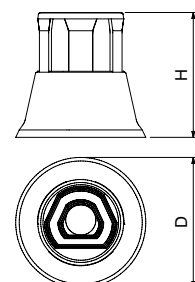

D	H	Kg	Color	Barcode	€
430	430	4,6	Blue	482202	
			Grey	482204	69,00
			Black	482212	

Caractéristiques:

Ce tabouret métallique a dans sa base trois rouelles qui permettent le déplacer facilement de long en large, avec un seul poussé du pied. En plus, lorsqu'on monte sur lui, il reste totalement fixé au sol, comme une ventouse, grâce à sa bande ronde en caoutchouc.

Esteras suspendidas

Hanging wall shelves
Étagères suspendues



Fabricadas totalmente en acero inoxidable. Esta gama de estanterías suspendidas está diseñada para ayudarle a organizar su espacio de trabajo con seguridad e higiene.

Los estantes son regulables en altura y cuentan con reborde perimetral que dará seguridad al contenido del estante, evitando a su vez posibles derrames y caídas de objetos.

Sus detalles de fabricación proporcionan firmeza y seguridad a toda la estructura.

Totally made in stainless steel. This range of hanging wall shelves is designed to help you to organize your working space in a safe and hygienic way. Their shelves are height adjustable, and are provided with a perimeter flange that will allow a secure storage and will avoid any accidental edge leakage. The particular manufacturing features provide stability and robustness to the whole structure.

Fabriqué entièrement en acier inoxydable, cette gamme de rayonnages suspendus est conçu pour vous aider à organiser votre espace de travail en total sécurité et hygiène.

Les étagères sont réglables en hauteur et ont un rebord qui donnera sécurité au contenu de l'étagère en empêchant les possibles déversements. Ces détails de fabrication fournissent fermeté et sécurité à toute la structure.

015400 4 X 49€

Kit de fijación a techo para estanterías suspendidas
Ceiling fixing kit for hanging shelves
Kit de montage pour plafond pour étagères suspendues



081802 25 462

Porta-notas mural
Wall-mounted tab grabber
Porte-notes mural

486024 24 389

Contenedor de desperdicios y reciclaje
Waste and recycling container
Conteneur à ordures et recyclage

276044 35 320

Adaptador contenedor desperdicios
Cutlery basket adaptor for service trolleys
Adaptateur de conteneurs pour chariots de service

454860 2,50 460

Cestillo de plástico para cubiertos
Plastic cutlery basket
Plateau à couverts en plastique

276042 18 320

Adaptador de cestillos cuberteros
Container adaptor for service trolleys
Adaptateur de panier à utensiles de cuisine pour chariots de service

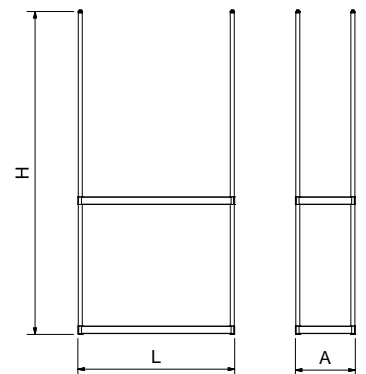

Incluido / Included / Inclus
Opcional / Optional / Optionnel

⚠ Posibilidad de añadir estantes adicionales. Preparado para atornillar mediante taco expansor.
Possibility of adding additional shelves. Ready for fixing with expansion shell anchors. Des étagères supplémentaires peuvent être ajoutées.
Préparé pour le vissage au moyen d'un bouchon d'expansion.

L	A	H	Kg	Barcode	€	Kg	Barcode	€
991	391	2.000	8,0	015402	323,00	3,6	276060	111,00
1.391	391	2.000	10,6	015404	391,00	4,9	276062	136,00
1.891	391	2.000	13,8	015406	469,00	6,5	276064	164,00

Estanterías de sobremesa
 Desktop shelves
 Étagères à poser sur table

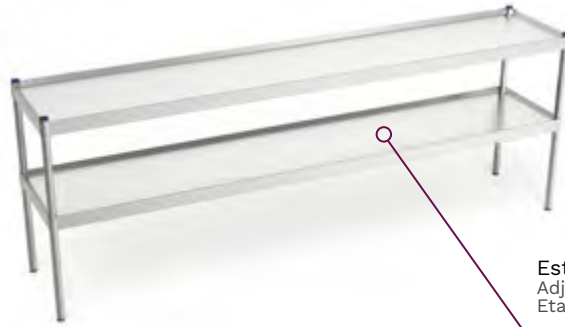

Estantes regulables en altura
 Adjustable shelves
 Étagères réglables en hauteur

Entrepañó opcional
 Optional shelf
 Tablette en option



081802 25 462

Porta-notas mural
 Wall mounted note-holder
 Porte-notes mural



085014 4 X 10€

Kit de fijación
 Fixing kit
 Kit de fixation

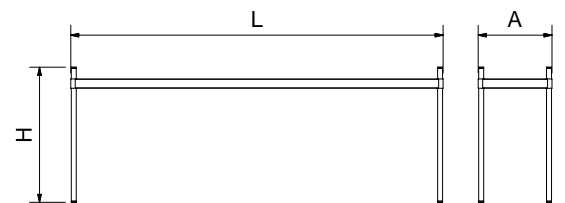

Instalación de sobremesa con o sin fijación.
 Installation on worktop with or without attachment.
 Installation sur dessus avec ou sans fixation.

L	A	H	Kg	€	Kg	€		
991	391	677	3,8	076060	205,00	3,6	276060	111,00
1.391	391	677	5,1	076062	253,00	4,9	276062	136,00
1.891	391	677	6,7	076064	301,00	6,5	276064	164,00

Includido / Included / Inclus
 Opcional / Optional / Optionnel



Optimice su espacio con esta nueva estación de trabajo



imagine GN es una nueva herramienta pensada para optimizar el espacio de trabajo. Este innovador sistema emplea un diseño Cantilever que elimina los soportes frontales, incrementando hasta un 40% más el espacio útil de trabajo dentro de la misma zona.

Se instala con facilidad y rapidez. Basado en las dimensiones internacionales GASTRONORM, está fabricado totalmente en acero inoxidable, con un diseño moderno y único.

imagine GN lo podrá utilizar para almacenamiento tanto en lugares secos como en ambientes con humedad, cocinas industriales, salas de preparación y elaboración de alimentos, laboratorios, clínicas, talleres, estaciones de servicio, etc.



Puede regular la altura (cada 140 mm.) y la inclinación de los estantes sin usar herramientas.
Shelves height (every 140 mm.) and lean can be adjusted without using any tool.
Vous pouvez régler l'hauteur (tous 140 mm.) et l'inclinaison des étagères sans utiliser des outils.

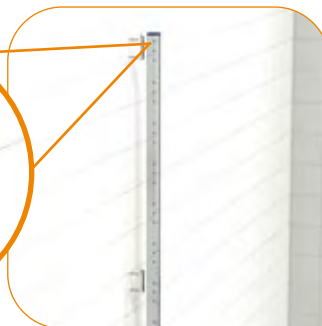

Con las soluciones modulares imagine GN puede configurar fácil y rápidamente su espacio de trabajo atendiendo a las necesidades de cambio.

imagine GN Optimize your space with this innovative work station.

imagine GN is a new tool, thought to optimize your work room. This innovative system employs a Cantilever design that eliminates the front supports, increasing up to a 40% the useful surface within the work area.

You can mount it easily and quickly. Based in the international dimensions GASTRONORM, it is made totally in stainless steel, with a modern and unique design.

imagine GN can be used to stock in dry areas as well as in places with wet atmosphere, industrial kitchens, food preparation rooms, laboratories, clinics, garages, petrol stations, etc.

With the imagine GN modular solutions you can easily and quickly design your working area meeting at the same time your needs of change.

Now with imagine GN you will be able to re-design your work area whenever it is necessary.

Detalle de fijación a pared.
Wall fixing detail.
Détails de fixation murale.

Video



Ahora con imagine GN podrá rediseñar su espacio de trabajo cuando sea necesario.

imagine GN Optimisez votre espace avec cette nouvelle station de travail.

imagine GN, c'est un nouveau outil conçu pour optimiser l'espace de travail. Cette innovateur système emploie, un dessin Cantilever qu'évite des supports frontaux, et c'est ainsi qu'on augmente la surface utile dans le zone de travail.

On l'installe facilement et rapidement. Dessinée sur les dimensions internationales Gastronorm, elle est fabriquée totalement en acier inoxydable avec une finition moderne et unique.

imagine GN, vous pouvez l'utiliser pour le stockage tandis dans endroits secs comme dans endroits avec atmosphère humide, cuisines industrielles, salles de préparation des aliments, laboratoires, cliniques, ateliers, stations-service, etc.



LAS NECESIDADES CAMBIAN

Needs change
Les besoins changent



Avec les solutions modulaires imagine GN vous pouvez configurer facile et rapidement votre espace de travail en tenant en compte au même temps votre besoins d'échange.

Maintenant avec imagine GN vous pourrez re-dessiner votre espace quand il soit nécessaire.

Reglajes y resistencia imagine
 Adjustment and load strength imagine
 Réglage et résistance imagine



Capacidad de estantes:

Sistema mural 10 niveles por módulo.
 Sistema central 10 niveles dobles por módulo.

Shelving unit capacity:

Wall-side system – 10 levels per unit.
 Centre system – 10 double levels per unit.

Capacité des étagères:

Système mural – 10 niveaux par module.
 Système central – 10 niveaux doubles par module.

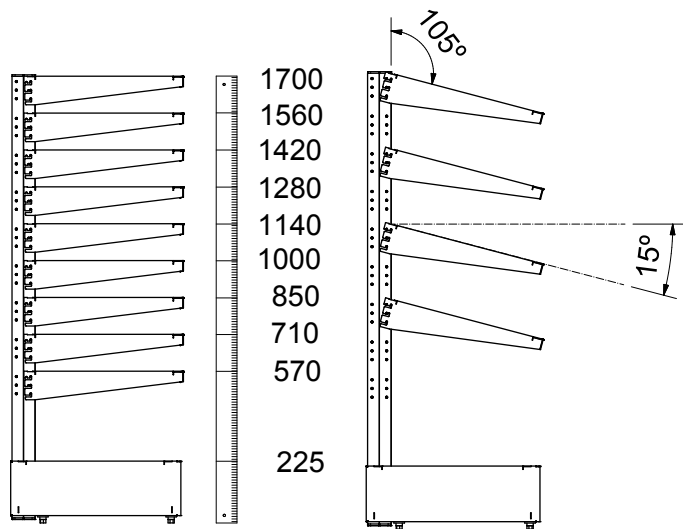

Kg = 125 Kg.

Las cargas se consideran uniformemente repartidas en la superficie del estante.

It is assumed that loads are evenly distributed on the shelf surface.

On considère que les charges sont réparties uniformément sur la surface de l'étagère.

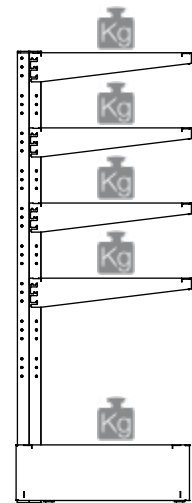

Estantería gastronorm imagine

Gastronorm Imagine shelving unit
Étagère gastronorm imagine

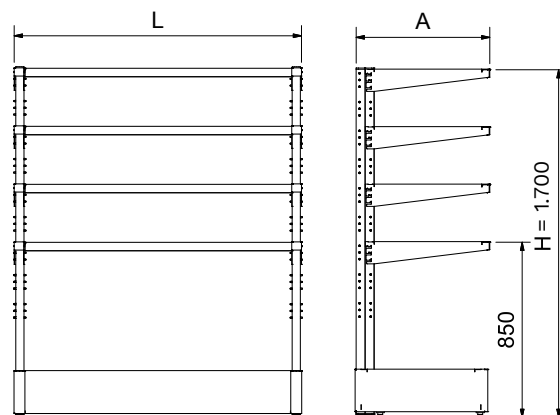

1/1 A = 451 mm
Número de estantes
Number of shelves
Numéro d'étagères

mm	3		4		5	
L	Barcode	€	Barcode	€	Barcode	€
764	016002	892,00	016102	1.028,00	016202	1.164,00
1.174	016004	984,00	016104	1.148,00	016204	1.312,00
1.414	016006	1.114,00	016106	1.316,00	016206	1.518,00
1.475	016008	1.481,00	016108	1.725,00	016208	1.969,00
1.885	016010	1.573,00	016110	1.845,00	016210	2.117,00
2.125	016012	1.703,00	016112	2.013,00	016212	2.323,00
2.186	016014	2.070,00	016114	2.422,00	016214	2.774,00
2.295	016016	1.665,00	016116	1.965,00	016216	2.265,00
2.535	016018	1.795,00	016118	2.133,00	016218	2.471,00
2.596	016020	2.162,00	016120	2.542,00	016220	2.922,00
2.775	016022	1.925,00	016122	2.301,00	016222	2.677,00
2.836	016024	2.292,00	016124	2.710,00	016224	3.128,00
3.006	016026	2.254,00	016126	2.662,00	016226	3.070,00
3.246	016028	2.384,00	016128	2.830,00	016228	3.276,00
3.307	016030	2.751,00	016130	3.239,00	016230	3.727,00
3.416	016032	2.346,00	016132	2.782,00	016232	3.218,00
3.486	016034	2.514,00	016134	2.998,00	016234	3.482,00
3.608	016036	3.248,00	016136	3.816,00	016236	4.384,00
3.717	016038	2.843,00	016138	3.359,00	016238	3.875,00
3.896	016040	2.606,00	016140	3.118,00	016240	3.630,00
4.018	016042	3.340,00	016142	3.936,00	016242	4.532,00

2/1 A = 656 mm
Número de estantes
Number of shelves
Numéro d'étagères

mm	3		4		5	
L	Barcode	€	Barcode	€	Barcode	€
764	016302	996,00	016402	1.154,00	016502	1.312,00
1.174	016304	1.118,00	016404	1.314,00	016504	1.510,00
1.414	016306	1.248,00	016406	1.482,00	016506	1.716,00
1.475	016308	1.652,00	016408	1.934,00	016508	2.216,00
1.885	016310	1.774,00	016410	2.094,00	016510	2.414,00
2.125	016312	1.904,00	016412	2.262,00	016512	2.620,00
2.186	016314	2.308,00	016414	2.714,00	016514	3.120,00
2.295	016316	1.896,00	016416	2.254,00	016516	2.612,00
2.535	016318	2.026,00	016418	2.422,00	016518	2.818,00
2.596	016320	2.430,00	016420	2.874,00	016520	3.318,00
2.775	016322	2.156,00	016422	2.590,00	016522	3.024,00
2.836	016324	2.560,00	016424	3.042,00	016524	3.524,00
3.006	016326	2.552,00	016426	3.034,00	016526	3.516,00
3.246	016328	2.682,00	016428	3.202,00	016528	3.722,00
3.307	016330	3.086,00	016430	3.654,00	016530	4.222,00
3.416	016332	2.674,00	016432	3.194,00	016532	3.714,00
3.486	016334	2.812,00	016434	3.370,00	016534	3.928,00
3.608	016336	3.620,00	016436	4.274,00	016536	4.928,00
3.717	016338	3.208,00	016438	3.814,00	016538	4.420,00
3.896	016340	2.934,00	016440	3.530,00	016540	4.126,00
4.018	016342	3.742,00	016442	4.434,00	016542	5.126,00

Estantería gastronorm imagine central

Gastronorm Imagine center shelving unit
Étagère gastronorm imagine centrale

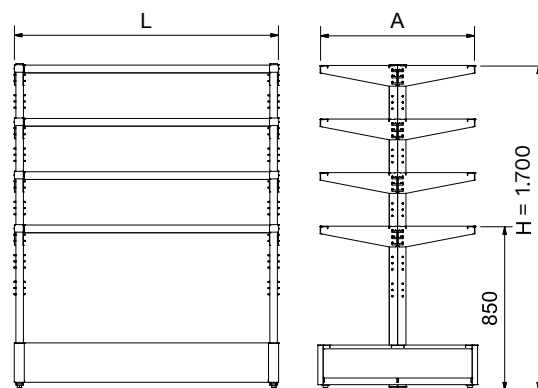

mm	1/1 A = 451 mm Número de estantes Number of shelves Numéro d'étagères			2/1 A = 656 mm Número de estantes Number of shelves Numéro d'étagères		
	3	4	5	3	4	5
L						
764	016602 1.602,00	016702 1.914,00	016802 2.226,00	016902 1.930,00	017002 2.290,00	017102 2.650,00
1.174	016604 1.798,00	016704 2.166,00	016804 2.534,00	016904 2.210,00	017004 2.654,00	017104 3.098,00
1.414	016606 2.130,00	016706 2.598,00	016806 3.066,00	016906 2.518,00	017006 3.054,00	017106 3.590,00
1.475	016608 2.733,00	016708 3.293,00	016808 3.853,00	016908 3.255,00	017008 3.897,00	017108 4.539,00
1.885	016610 2.929,00	016710 3.545,00	016810 4.161,00	016910 3.535,00	017010 4.261,00	017110 4.987,00
2.125	016612 3.261,00	016712 3.977,00	016812 4.693,00	016912 3.843,00	017012 4.661,00	017112 5.479,00
2.186	016614 3.864,00	016714 4.672,00	016814 5.480,00	016914 4.580,00	017014 5.504,00	017114 6.428,00
2.295	016616 3.125,00	016716 3.797,00	016816 4.469,00	016916 3.815,00	017016 4.625,00	017116 5.435,00
2.535	016618 3.457,00	016718 4.229,00	016818 5.001,00	016918 4.123,00	017018 5.025,00	017118 5.927,00
2.596	016620 4.060,00	016720 4.924,00	016820 5.788,00	016920 4.860,00	017020 5.868,00	017120 6.876,00
2.775	016622 3.789,00	016722 4.661,00	016822 5.533,00	016922 4.431,00	017022 5.425,00	017122 6.419,00
2.836	016624 4.392,00	016724 5.336,00	016824 6.320,00	016924 5.728,00	017024 6.996,00	017124 8.264,00
3.006	016626 4.256,00	016726 5.176,00	016826 6.096,00	016926 5.140,00	017026 6.232,00	017126 7.324,00
3.246	016628 4.588,00	016728 5.608,00	016828 6.628,00	016928 5.448,00	017028 6.632,00	017128 7.816,00
3.307	016630 5.191,00	016730 6.303,00	016830 7.415,00	016930 6.285,00	017030 7.475,00	017130 8.765,00
3.416	016632 4.452,00	016732 5.428,00	016832 6.404,00	016932 5.920,00	017032 6.596,00	017132 7.772,00
3.486	016634 4.920,00	016734 6.040,00	016834 7.160,00	016934 5.756,00	017034 7.032,00	017134 8.308,00
3.608	016636 6.126,00	016736 7.430,00	016836 8.734,00	016936 7.230,00	017036 8.718,00	017136 10.206,00
3.717	016638 5.387,00	016738 6.555,00	016838 7.723,00	016938 6.465,00	017038 7.839,00	017138 9.213,00
3.896	016640 5.116,00	016740 6.292,00	016840 7.468,00	016940 6.036,00	017040 7.396,00	017140 8.756,00
4.018	016642 6.322,00	016742 7.682,00	016842 9.042,00	016942 7.510,00	017042 9.082,00	017142 10.654,00

Estanterías gastronorm imagine a pared

Gastronorm Imagine wall-side shelving unit
Étagère gastronorm imagine pour mur

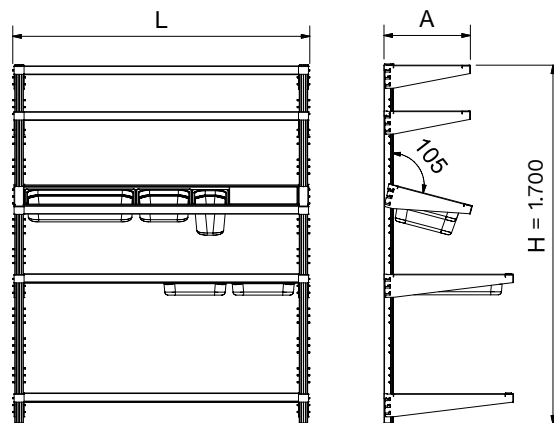

1/1 A = 451 mm
Número de estantes
Number of shelves
Numéro d'étagères

2/1 A = 656 mm
Número de estantes
Number of shelves
Numéro d'étagères

mm	1/1 A = 451 mm			2/1 A = 656 mm		
	3	4	5	3	4	5
L	Barcode	Barcode	Barcode	Barcode	Barcode	Barcode
764	017202 606,00	017302 742,00	017402 878,00	017502 672,00	017602 830,00	017702 988,00
1.174	017204 690,00	017304 854,00	017404 1.018,00	017504 786,00	017604 982,00	017704 1.178,00
1.414	017206 804,00	017306 1.006,00	017406 1.208,00	017506 900,00	017606 1.134,00	017706 1.368,00
1.475	017208 1.029,00	017308 1.273,00	017408 1.517,00	017508 1.143,00	017608 1.425,00	017708 1.707,00
1.885	017210 1.113,00	017310 1.385,00	017410 1.657,00	017510 1.257,00	017610 1.577,00	017710 1.897,00
2.125	017212 1.227,00	017312 1.537,00	017412 1.847,00	017512 1.371,00	017612 1.729,00	017712 2.078,00
2.186	017214 1.452,00	017314 1.804,00	017414 2.156,00	017514 1.614,00	017614 2.020,00	017714 2.426,00
2.295	017216 1.197,00	017316 1.497,00	017416 1.797,00	017516 1.371,00	017616 1.729,00	017716 2.087,00
2.535	017218 1.311,00	017318 1.649,00	017418 1.987,00	017518 1.485,00	017618 1.881,00	017718 2.277,00
2.596	017220 1.536,00	017320 1.916,00	017420 2.296,00	017520 1.728,00	017620 2.172,00	017720 2.616,00
2.775	017222 1.425,00	017322 1.801,00	017422 2.177,00	017522 1.599,00	017622 2.033,00	017722 2.467,00
2.836	017224 1.650,00	017324 2.068,00	017424 2.486,00	017524 1.842,00	017624 2.324,00	017724 2.806,00
3.006	017226 1.620,00	017326 2.028,00	017426 2.436,00	017526 1.842,00	017626 2.324,00	017726 2.806,00
3.246	017228 1.734,00	017328 2.180,00	017428 2.626,00	017528 1.956,00	017628 2.476,00	017728 2.996,00
3.307	017230 2.935,00	017330 2.447,00	017430 2.935,00	017530 2.199,00	017630 2.767,00	017730 3.355,00
3.416	017232 2.576,00	017332 2.140,00	017432 2.576,00	017532 1.656,00	017632 2.476,00	017732 2.996,00
3.486	017234 1.848,00	017334 2.332,00	017434 2.816,00	017534 2.070,00	017634 2.628,00	017734 3.186,00
3.608	017236 2.298,00	017336 2.866,00	017436 3.434,00	017536 2.556,00	017636 3.210,00	017736 3.864,00
3.717	017238 2.043,00	017338 2.559,00	017438 3.075,00	017538 2.313,00	017638 2.919,00	017738 3.525,00
3.896	017240 2.956,00	017340 2.444,00	017440 2.956,00	017540 2.184,00	017640 2.780,00	017740 3.376,00
4.018	017242 2.382,00	017342 2.978,00	017442 3.574,00	017542 2.670,00	017642 3.362,00	017742 4.054,00

Pies murales imagine
Wall-side legs imagine
Pieds muraux imagine

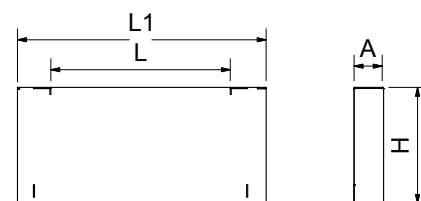

L	A	H	L1	Kg	Barcode	€
325	53	210	450	3,50	013806	89,00€
530	53	210	655	5,25	013808	114,00€

Pies centrales imagine
Centre legs imagine
Pieds centraux imagine

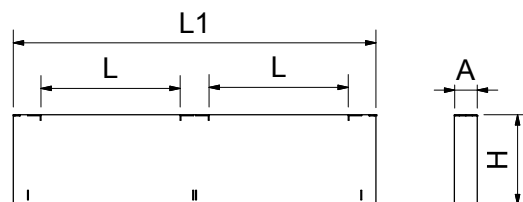

L	A	H	L1	Kg	Barcode	€
325	53	210	850	6,2	013802	135,00€
530	53	210	1.260	9,2	013804	225,00€

Largueros inferiores imagine
Lower crossbars imagine
Montants inférieurs imagine

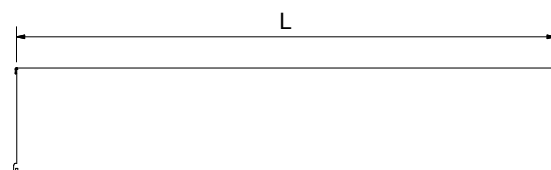

L	Kg	Barcode	€
665	2,7	014252	46,00
1.075	4,0	014254	59,00
1.315	5,4	014256	74,00

Soporte imagine
Support imagine
Support imagine

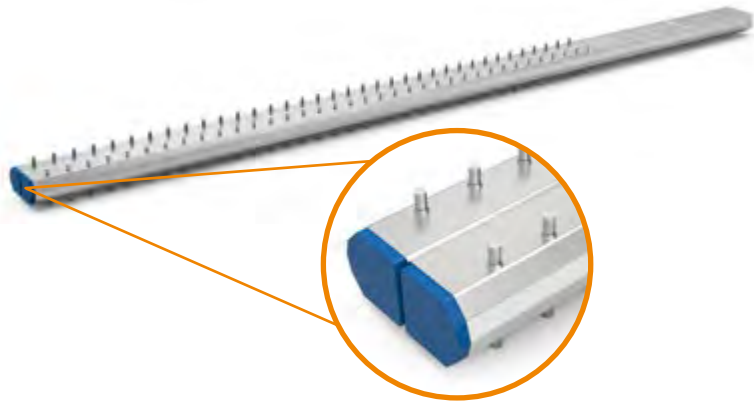
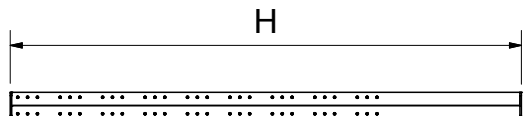
H	Kg	Barcode	€
1.700	6	013602	158,00

Soporte imagine a pared
Support for Imagine hanging wall shelf
Support pour Imagine murale suspendue

H	Kg	Barcode	€
860	1,5	013606	64,00
1.700	3,0	013604	99,00

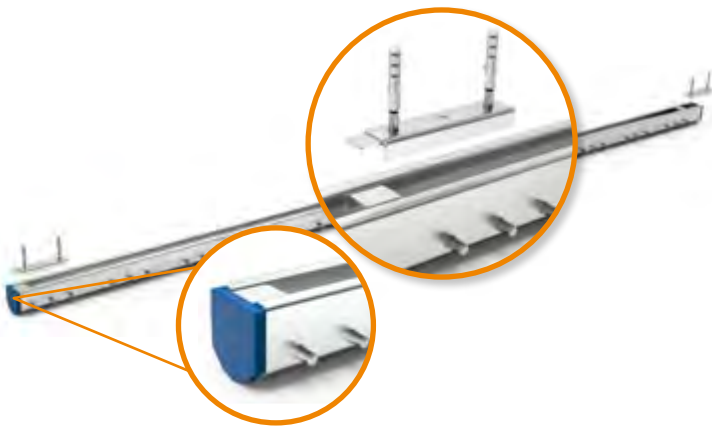
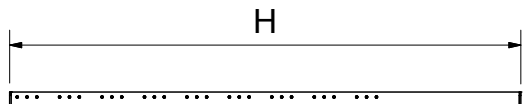
Cartelas imagine
Brackets imagine
Consoles imagine

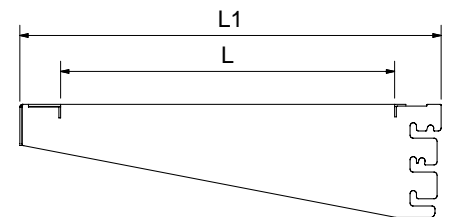

L	L1	Kg	Barcode	€
325	410	1,8	014002	28,00
530	615	2,5	014004	34,00

Largueros superiores imagine
Upper crossbars imagine
Montants supérieurs imagine

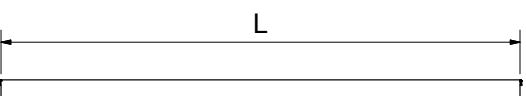
L	Kg	Barcode	€
665	1,3	014202	23,00
1.075	1,9	282806	32,00
1.315	2,4	014204	39,00

Estantes inox imagine

Stainless steel shelves imagine
Étagères en acier inoxydable imagine

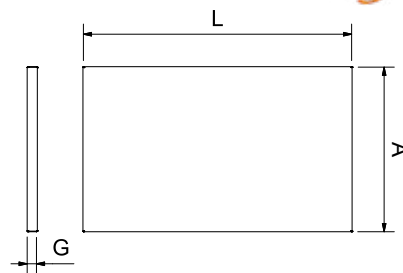

L	A	G	Kg	Barcode	€
325	325	20	1,0	013402	17,00€
530	325	20	1,5	013404	22,00€
530	530	20	2,0	013406	32,00€

Estantes fibra imagine

Polyethylene shelves imagine
Étagères en polyéthylène imagine

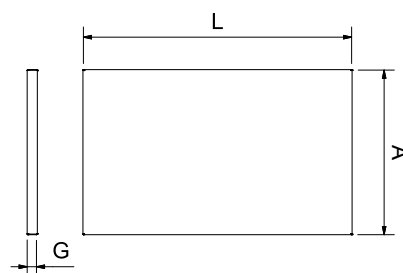
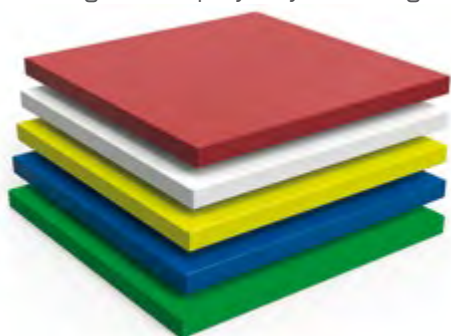

Color	L	A	G	Kg	Barcode	€
Red	325	325	20	2,12	434602	21,00
	530	325	20	3,45	434604	33,00
	530	530	20	5,62	434606	55,00
White	325	325	20	2,12	434610	21,00
	530	325	20	3,45	434612	33,00
	530	530	20	5,62	434614	55,00
Yellow	325	325	20	2,12	434620	21,00
	530	325	20	3,45	434622	33,00
	530	530	20	5,62	434624	55,00
Blue	325	325	20	2,12	434630	21,00
	530	325	20	3,45	434632	33,00
	530	530	20	5,62	434634	55,00
Green	325	325	20	2,12	434640	21,00
	530	325	20	3,45	434642	33,00
	530	530	20	5,62	434644	55,00

Hacer agujero de desbarasado a estantes imagine

Imagine shelf perforation for waste chutes
Perforer étagère imagine pour évacuation de déchets



	Acero inoxidable Stainless steel Acier inoxydable	015002	59,00
	Fibra Fibre Fibre	434802	33,00

Kit para colgar utensilios imagine

Tool-holder kit imagine
Kit pour accroche des outils imagine



46

H	E	D	Barcode	L	✓	Kg	Barcode	€
60	16	3	9200606022502	650	10	0,30	014602	33,00
1.060	10	0,50	014604	1.060	10	0,50	014604	35,00
1.300	20	0,65	014606	1.300	20	0,65	014606	36,00

Boxes modulares

Modular boxes
Boxes modulaires



312

Con este sistema de boxes modulares ya puede configurar a su medida las mesas, fregaderos, estanterías, tajos, etc.

Basados en las dimensiones internacionales GASTRONORM están fabricados totalmente en acero inoxidable. Su diseño moderno y funcional permite adaptar guías, cajones, cubetas, puertas etc.

With this system of modular boxes now you can adapt to your needs tables, sink units, shelving units, chopping blocks, etc.

Based in the international dimensions GASTRONORM, it is made totally from stainless steel. Its innovative and functional design allows the fitting of elements such as guides, drawers, pans, doors, etc.

Avec le système de boxes modulaires maintenant vous pouvez adapter à vos besoins tables, éviers, étagères, billots, etc.

Ce système, basé dans les mesures internationales GASTRONORM, est fabriqué totalement en acier inoxydable. Sa conception moderne et fonctionnelle permet d'adapter guides, tiroirs, bacs, portes, etc.

Cajón acoplado a estante 2/1 imagine

Drawer assembled to shelf 2/1 imagine
Tiroir assemblé à étagère 2/1 imagine



085450 **273,00**



085452 **306,00**

Porta-precios imagine

Price-holder imagine
Porte prix imagine



Se acoplan con facilidad a los largueros superiores.

Easy to assemble to the upper crossbars.

Facilité d'assemblage aux montants supérieurs.

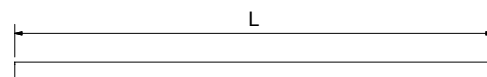

L	Gr	Barcode	€
650	65	415250	5,25
1.060	105	415252	8,40
1.300	130	415254	9,45

Útil de montaje imagine

Assembly tool imagine
Outil de montage imagine



Facilita considerablemente el montaje.

It makes the assembly greatly easier.

Il facilite l'assemblage.

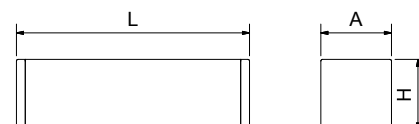

L	A	H	Gr	Barcode	€
125	40	40	180	014402	5,00

Peto transparente imagine

Transparent front panel for imagine
Panneau frontal transparent pour imagine

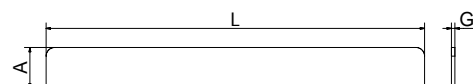

L	A	G	Gr	Barcode	€
655	70	6	175	014802	43,00
1.065	70	6	250	014804	55,00
1.305	70	6	375	014806	65,00

Mesa central de emplatado imagine

Preparing and serving centre table imagine
Table centrale pour préparation et service imagine



435

Cubetas Gastronorm.
Gastronorm trays.
Bacs gastronorm.



434602 21,00
434802 33,00 29

Estante en fibra de polietileno con agujero.
Perforated polyethylene shelves.
Étagères perforées en polyéthylène.



486004 187,00 386

Contenedor inoxidable con tapa.
Stainless steel dustbin.
Poubelle inox.



87

Cuchillería profesional.
Professional cutlery.
Coutellerie professionnelle.

Includido / Included / Inclus
 Opcional / Optional / Optionnel

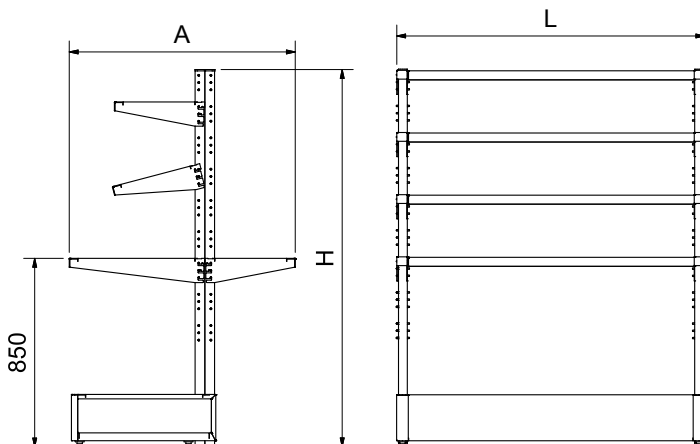

L	A	H	Kg	Barcode	€
764	1.050	1.700	61	910020402	1.246,00
1.174	1.050	1.700	71	910020404	1.414,00
1.414	1.050	1.700	82	910020406	1.620,00

Mesa mural con estantes sobremesa serie imagine

Wall-side table with superior shelves serie imagine

Table murale avec étagères sur table modèle imagine



014602 33,00 30

Kit para colgar utensilios.
Tool-holder kit.
Kit pour suspendre outils.



448616 115,00 354

Guante de malla de acero inoxidable Expert.
Expert stainless steel mesh glove.
Gant en maille d'acier inoxydable Expert.

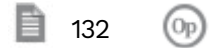

Tijeras pescadero.
Fish scissors.
Ciseaux à poisson.



434602 21,00
434802 33,00 29

Estante en fibra de polietileno con agujero.
Perforated polyethylene shelves.
Étagères perforées en polyéthylène.



Cuchillería profesional.
Professional cutlery.
Coutellerie professionnelle.



Cubetas Gastronorm.
Gastronorm trays.
Bacs gastronorm.



486004 187,00 386

Contenedor inoxidable con tapa.
Stainless steel dustbin.
Poubelle inoxydable.



085452 306,00 30

Cajón acoplado.
Coupled drawer.
Tiroir accouplé.

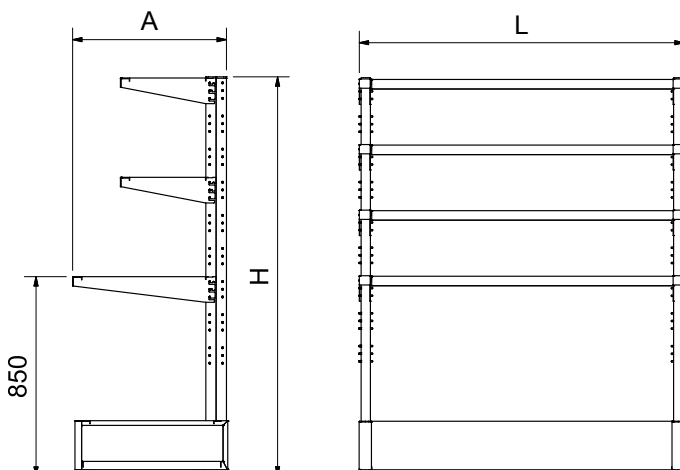

Incluido / Included / Inclus
 Opcional / Optional / Optionnel

L	A	H	Kg	Barcode	€
764	655	1.700	55	910020502	1.110,00
1.174	655	1.700	64	910020504	1.250,00
1.414	655	1.700	73	910020506	1.418,00

Mesa central con estantes de sobremesa sistema imagine

Centre table with tabletop shelves imagine system

Table centrale avec étagères à poser sur table système imagine



081802 25,00 462

Porta notas mural acoplado.
Wall-mounted tab grabber.
Porte notes mural.



434442 140,00 85

Mortero de fibra.
Mortar.
Mortier.



080202 60,00 399

Dispensador de bobinas para envolver de 350 mm.
Dispenser rolls of wrapping material.
Dévidoir de rouleaux pour protéger les aliments.



434440 52,00 84

Rodillo de fibra.
Rolling pin.
Rouleau.



87

Cuchillería profesional.
Professional cutlery.
Coutellerie professionnelle.



486004 187,00 386

Contenedor inoxidable con tapa.
Stainless steel dustbin.
Poubelle inoxydable.



431608 32,00 75

Fibra estándar azul de 500x300x20 mm.
Blue standard fibre 500x300x20 mm.
Fibre standard bleue 500x300x20 mm.



041202 123,00 137

Portacuchillos con doble alojamiento de sobremesa.
Plated knife holder for mounting.
Porte-couteaux plaqué pour adosser.

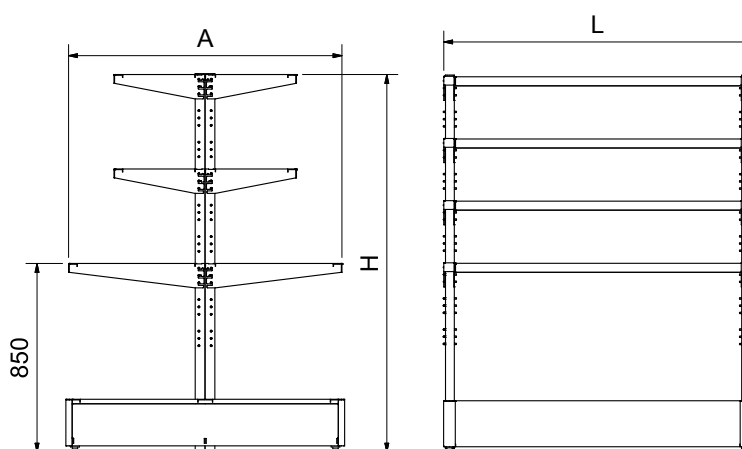

L	A	H	Kg	Barcode	€
764	1.255	1.700	77	910020602	1.898,00
1.174	1.255	1.700	95	910020604	2.178,00
1.414	1.255	1.700	115	910020606	2.514,00

Incluido / Included / Inclus
 Opcional / Optional / Optionnel

Estantería con armario para botellas de zumo

Shelf with cupboard for juice bottles

Rayonnage avec armoire pour bouteilles de jus de fruits

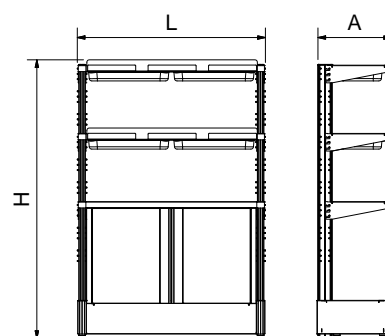

L	A	H	🔧	🔄	📦	📊	€
1.174	451	1.700	3	2	73,00	013060	1.975,00

Accesorios para estanterías

Accessories for shelves

Accessoires pour étagères



Cajones
Drawers
Tiroirs

492



Boxes modulares
Modular boxes
Boxes modulaires

312



Ruedas
Wheels
Rouelle

496



Taco regulable para soporte de estantería
Adjustable block for shelving support
Taquet réglable pour supports de rayonnage

498



Cubetas Gastronorm lisas
Non-perforated Gastronorm containers
Bacs Gastronorm lisses



435

Estantería inox para almacenaje de vino

Stainless steel shelving for wine storage

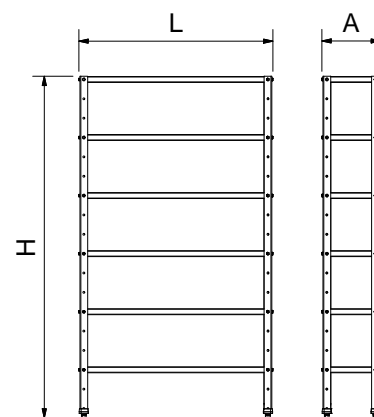
Rayonnage en acier inoxydable pour le stockage du vin





L	A	H				€
800	300	1.750	8	24,78	083020	443,00
1.000	300	1.750	11	27,33	083022	531,00
1.200	300	1.750	13	30,94	083024	612,00
1.400	300	1.750	15	34,55	083026	690,00

Estante inox para almacenaje de vino

Stainless steel shelf for wine storage

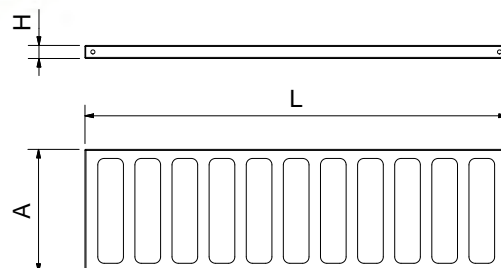
Étagère inox pour stockage du vin



L	A	H				€
800	300	31	8	2,68	283020	59,00
1.000	300	31	11	3,10	283022	76,00
1.200	300	31	13	3,71	283024	93,00
1.400	300	31	15	4,31	283026	109,00



Botellero de sobremesa para botellas de vino
 Countertop rack for wine bottles
 Porte-bouteilles support sur table pour vin

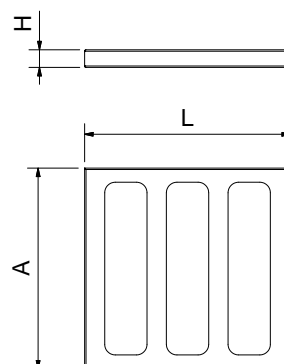
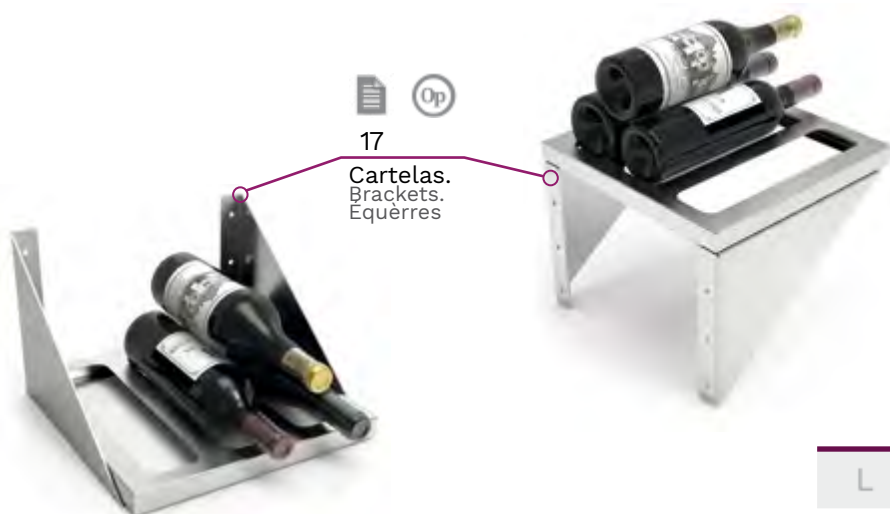

L	A	H	Kg	Barcode	€
292	285	25	0,67	083028	27,00



Botellero expositor inox de sobremesa para botellas de vino
 Stainless steel countertop rack for displaying wine
 Porte-bouteilles présentoir de table en inox pour bouteilles de vin



17

Cartelas.
 Brackets.
 Équerres

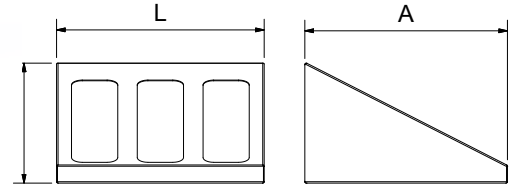

L	A	H		Kg		€
292	285	169	3	1,36	083030	49,00





HERRAJES

HOOKS AND STAINLESS STEEL FIXTURES
FERRURES ET CROCHETS



NOVEDADES
NEWS
NOUVEAUTÉS



52



57



59

Columnas perforadas para pletina

Perforated columns for flat bar
Colonnes perforées pour platine



Características:

La ventaja del sistema de columnas perforadas para pletina es la facilidad de montaje, pues al pasar la pletina a través de la columna nos permite desplazarla lateralmente (en caso de encontrar algún obstáculo como un desagüe que vaya a la pared, etc.). Con el sistema de separadores estándar se consigue adaptar perfectamente todo el conjunto de columnas al perímetro de la cámara, logrando una excelente estabilidad, además de no tener que quitar las curvas sanitarias que todas las cámaras llevan en paredes y suelos.

Como opción se pueden solicitar pletinas de cruce (tal y como figura en la fotografía), teniendo en cuenta que la distancia entre columnas no debe superar los 1.000 mm. También se fabrican, bajo pedido, columnas para apoyo con diferentes alturas de barras.

La pletina para estas columnas tiene que ser de 40x8 mm necesariamente.

Characteristics:

The main advantage of the perforated column system for plate is the ease of installing, since when passing the plate through the column you can move it laterally in the case of any obstacle (such as any drainpipe on the wall, etc.). Furthermore, and with the standard detacher system, you can get a perfect joint of the whole column set within the chamber perimeter, resulting in an excellent stability. Also, there is no need to remove the sanitary curve all chambers have in walls and floor.

In addition, and as an option, you can ask for crossing plates (as can be seen in the drawing), taking into account that distance between columns must not exceed 1.000 mm. They are made as well in several height bars, etc previous order. Plate for these columns must be 40x8 mm compulsory.

Caractéristiques:

La principale avantage du système de colonnes perforées pour platines c'est la facilité du montage, car quand on passe la platine à travers la colonne, il est possible le déplacement latéral dans le cas de trouver quelque obstacle (comme les décharges des eaux dans le mur, etc.). Autre cela, et avec le système standard des séparateurs, on achève une parfaite adaptation pour l'assemblage dans tout le périmètre du chambre. En plus, on n'a pas besoin de quitter les courbures sanitaires que tous les chambres doivent avoir dans murs et sol.

En autre, et optionnellement, vous pouvez commander platines d'intersection (tel que la photographie) en tenant en compte la distance entre colonnes, qu'elle ne doit pas excéder 1.000 mm. Les colonnes, elles sont fabriquées pour support commande préalable, avec différent hauteur des barres, etc. Les platines pour ces colonnes doivent être 40x8 mm obligatoirement.



¿Necesita ayuda?

Díganos las medidas útiles interiores de la cámara (largo x ancho x alto), ubicación de la puerta y sus medidas (ancho x alto). Le informaremos del precio, plazo de entrega e instrucciones de montaje.

Need some help?

Tell us the interior dimensions of the useful area in the room (length x width x height) as well as the location of the door and its measurements (width x height). We will provide you the price, delivery time and assembly instructions.

Vous avez besoin d'aide?

Dites-nous les mesures intérieures utiles de la pièce (longueur x largeur x hauteur), l'emplacement de la porte et ses mesures (largeur x hauteur). Nous vous informerons du prix, du délai de livraison et des instructions de montage.

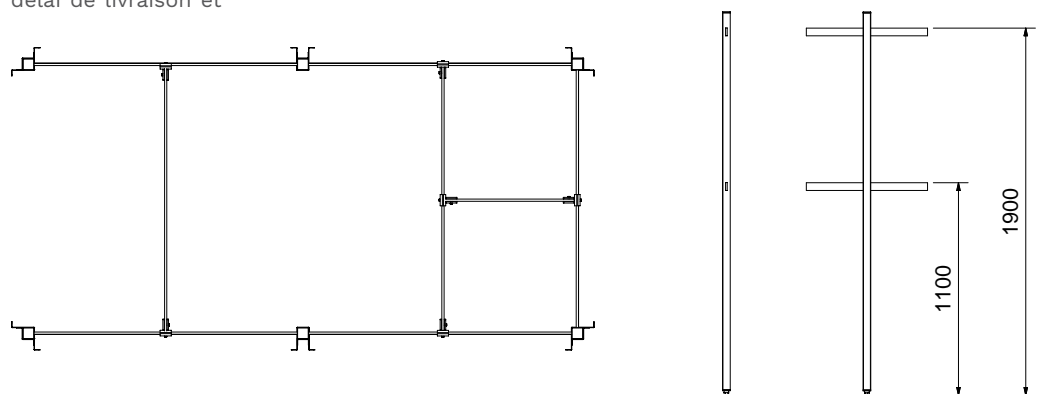

Necesitan 3 separadores por columna para su instalación.
3 separators are required for their installing.
Il sont nécessaires 3 séparateurs pour son installation.

Tornillos opcionales.
Optional screws and bolts.
Vis optionnelles.



	Central Center Central	Esquina Corner Coin	Terminal Terminal Terminal
Sección Section Section			
	40x40	020204	020206
	2,44	57,00	57,00
	€	€	€
	020202	020204	020206
	57,00	57,00	57,00

Separadores centrales

Central separators
Séparateurs central

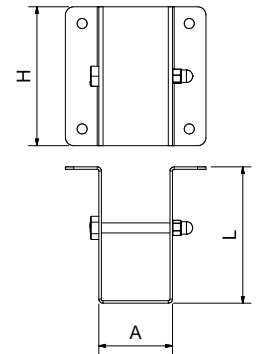

L	A	H	Gr	Barcode	€
80	40	83	300	020402	17,00
140	40	83	600	020406	20,00

Separadores de esquina

Corner separators
Séparateurs de coin

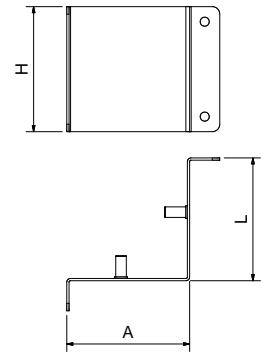

L	A	H	Gr	Barcode	€
80	80	83	300	020404	17,00
140	140	83	600	020408	20,00

Detalles

Details
Détails

Detalle de columna terminal.
Details of terminal column.
Détail colonne terminal.

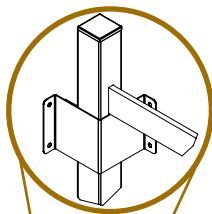

Detalle de columna central.
Details of the central column.
Détail colonne centrale.

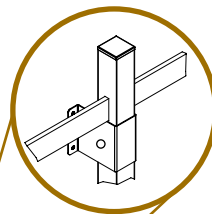

Detalle de columna en esquina.
Details of the corner column.
Détail colonne sur coin.

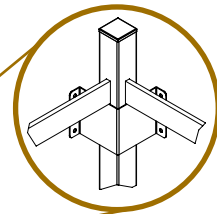

Detalle de pletinas transversales.
Details of the transversal plates.
Détail barres transversales.

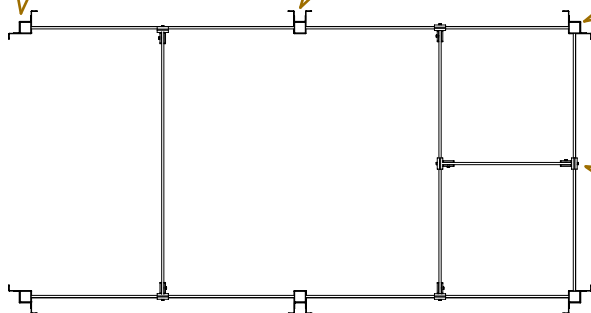
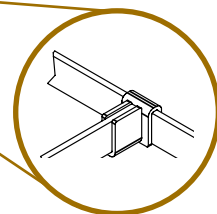

Columnas para tubo de 38 mm

Columns for 38 mm round tube
Colonnes pour tubes 38 mm



¿Necesita ayuda?

Díganos las medidas útiles interiores de la cámara (largo x ancho x alto), ubicación de la puerta y sus medidas (ancho x alto). Le informaremos del precio, plazo de entrega e instrucciones de montaje.

Need some help?

Tell us the interior dimensions of the useful area in the room (length x width x height) as well as the location of the door and its measurements (width x height). We will provide you the price, delivery time and assembly instructions.

Vous avez besoin d'aide?

Dites-nous les mesures intérieures utiles de la pièce (longueur x largeur x hauteur), l'emplacement de la porte et ses mesures (largeur x hauteur). Nous vous informerons du prix, du délai de livraison et des instructions de montage.

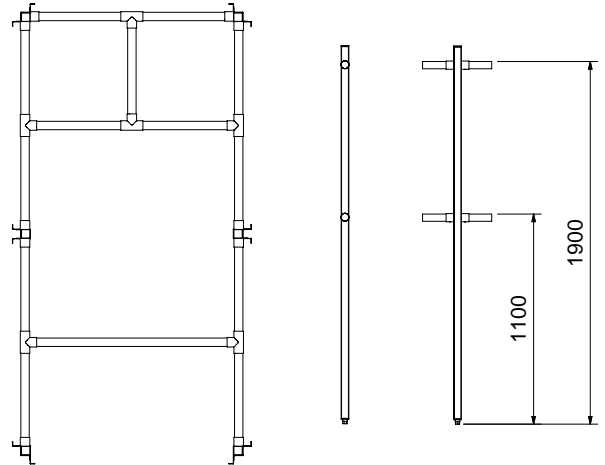

Necesitan 3 separadores por columna para su instalación.

3 separators are required for their installing.

Il sont nécessaires 3 séparateurs pour son installation.

Tornillos opcionales.

Optional screws and bolts.

Vis optionnelles.



Central
Central

Esquina
Corner
Coin

Terminal
Terminal
Terminal

Sección
Section
Section



40x40

2,44

020802

166,00

020804

166,00

020806

136,00

Detalle de columna terminal.
Details of terminal column.
Détail colonne terminal.

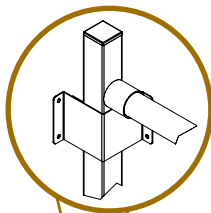

Detalle de columna central.
Details of the central column.
Détail colonne centrale.

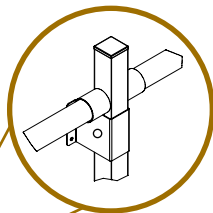

Detalle de columna en esquina.
Details of the corner column.
Détail colonne sur coin.

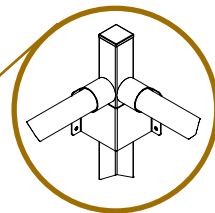

Detalle de tubos transversales.
Details of the transversal pipes.
Détail tubes transversales.

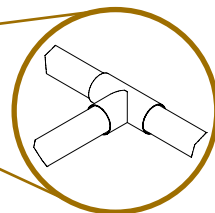

Pletinas
Flat bars
Platines

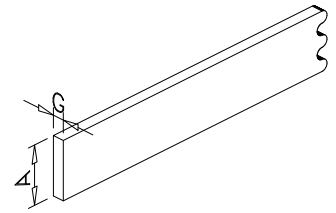

Peso por metro.
Weight per meter.
Poids par mètre.

Concepto Concept Concept		€
Corte a medida Custom cut Coupe sur mesure	021004	4,00
Taladro Drill hole Tariere	021002	7,00

					Precio 1 m. 1 m. price Prix 1 m.
A	G	Gr		€	
20	5	800	407808	13,00	
30	5	1.200	407811	19,00	
40	5	1.600	407816	22,00	
40	6	1.920	407820	25,00	
40	8	2.560	407828	30,00	
40	10	3.200	407838	37,00	
50	8	3.200	407832	38,00	

Tubos pulidos
Polished tubes
Tubes polis

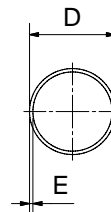

Peso por metro.
Weight per meter.
Poids par mètre.



Existen tapones de plástico para tapar los extremos del tubo.
There are plastic taps to cover the ends of the tube.
Il y a des bouchers en plastic pour couvrir les bouts du tube.

499

Concepto Concept Concept		€
Corte a medida Custom cut Coupe sur mesure	021004	4,00
Tapar extremos inox Inox end cover Boucher extremes inox	021202	25,00

					Precio m m price Prix m
D	E	Gr		€	
10	1,0	227	406810	5,00	
16	1,0	377	406824	6,00	
20	1,5	695	407013	8,00	
25	1,0	600	406832	8,00	
25	1,5	885	407020	11,00	
30	1,5	1.070	407028	12,00	
30	2,0	1.400	407206	15,00	
35	1,5	1.195	407036	14,00	
38	1,5	1.370	407040	15,00	
43	1,5	1.475	407048	17,00	

Ganchos forjados
 Forged hooks
 Crochets forgés

		Uso Use Usage	D	H	E	L	✓	Gr	Barcode	€
	Cordero Lamb Agneau	8	55	8			10	750	920060102	40,00
	½ Ternera ½ Calf ½ Veau	10	70	8			1	140	021404	8,00
	Ternera Calf Veau	12	111	8			1	280	021406	14,00
	Vaca Cow Boeuf	16	135	8			1	505	021408	26,00

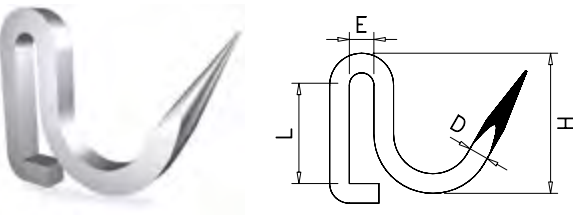
	Cordero Lamb Agneau	8	55	8	42		10	800	920060202	90,00
	½ Ternera ½ Calf ½ Veau	10	70	8	42		1	145	021604	32,00
	Ternera Calf Veau	12	105	8	42		1	290	021606	42,00
	Vaca Cow Boeuf	16	135	8	42		1	525	021608	53,00

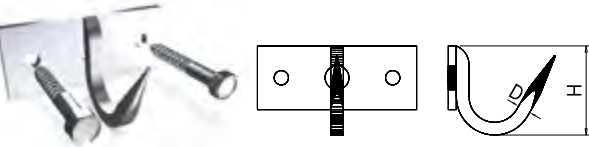
	Cordero Lamb Agneau	8	60				1	120	021802	36,00
	½ Ternera ½ Calf ½ Veau	10	70				1	170	021804	40,00
	Ternera Calf Veau	12	105				1	345	021806	50,00
	Vaca Cow Boeuf	16	135				1	665	021808	59,00

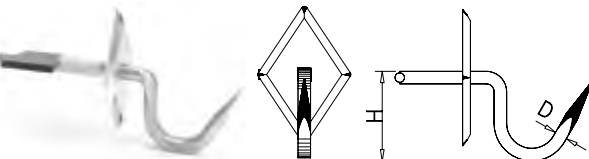
	Cordero Lamb Agneau	8	60				1	115	022002	39,00
	½ Ternera ½ Calf ½ Veau	10	70				1	150	022004	42,00
	Ternera Calf Veau	12	105				1	325	022006	56,00
	Vaca Cow Boeuf	16	135				1	645	022008	71,00

Ganchos de varilla modelo " J "

Rod hooks " J " shaped
Crochets à tige modèle " J "

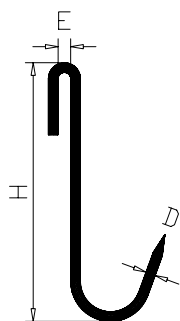

				Grosor de varilla Rod thickness Grosueur de la tige							
H	E	✓	Gr	D = 5 mm		✓	Gr	D = 6 mm		✓	Gr
50	9	10	200	9200603022202	8,10	10	350	9200603022216	10,80		
100	9	10	300	9200603022204	8,30	10	450	9200603022218	11,10		
120	9	10	350	9200603022206	8,60	10	500	9200603022220	11,30		
140	9	10	380	9200603022208	8,80	10	570	9200603022222	11,40		
160	9	10	400	9200603022210	10,10	10	600	9200603022224	12,40		
180	9	10	450	9200603022212	11,70	10	650	9200603022226	13,70		
200	9	10	500	9200603022214	14,00	10	700	9200603022228	14,00		

				Grosor de varilla Rod thickness Grosueur de la tige									
H	E	✓	Gr	D = 7 mm		D = 10 mm		D = 14 mm		✓	Gr		
100	9	10	700	9200603022230	15,40								
120	9	10	750	9200603022232	16,10								
140	9	10	800	9200603022234	17,50	1	180	022242	6,33	1	340	022254	10,53
160	9	10	850	9200603022236	18,90	1	195	022244	6,55	1	355	022256	11,41
180	9	10	900	9200603022238	20,30	1	205	022246	7,02	1	365	022258	12,29
200	9	10	1000	9200603022240	21,90	1	220	022248	7,02	1	380	022260	13,17
230	9					1	235	022250	7,02	1	395	022262	14,04
260	9					1	260	022252	7,02	1	420	022264	14,92

Gancho de varilla modelo " J "

Model " J " rod hook
Crochet à tige modèle " J "

H	E	D	✓	Gr	Barcode	€
55	8	5	10	250	9200608022266	21,70
60	9	7	10	480	9200605022229	9,60
100	9	5	1	51	022270	1,52
160	9	5	1	73	022272	1,62

Ganchos de varilla modelo " S "

Rod hooks " S " shaped
Crochets à tige modèle " S "

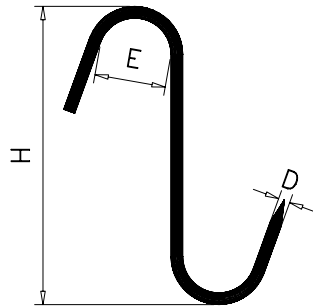

Grosor de varilla Rod thickness Grosueur de la tige						
D = 5 mm						
H	E	✓	Gr	Barcode	€	
100	30	10	300	9200604022404	7,60	
120	39	10	350	9200604022406	8,80	
140	39	10	450	9200604022408	9,60	
160	39	10	500	9200604022410	10,00	
180	39	10	550	9200604022412	10,50	
200	39	10	580	9200604022414	11,10	

Grosor de varilla Rod thickness Grosueur de la tige													
D = 6 mm						D = 7 mm				D = 10 mm			
H	E	✓	Gr	Barcode	€	✓	Gr	Barcode	€	✓	Gr	Barcode	€
120	39	10	550	9200604022416	11,40								
140	39	10	600	9200604022418	11,70								
160	39	10	700	9200604022420	12,30	10	950	9200604022426	16,60				
180	39	10	750	9200604022422	13,30	10	1050	9200604022428	17,60				
200	39	10	800	9200604022424	15,40	10	1100	9200604022430	18,40	1	255	022432	5,76
230	39									1	270	022434	5,99
260	39									1	290	022436	6,28

Ganchos de varilla modelo " S "

" S " model rod hooks
Crochets à tige modèle " S "

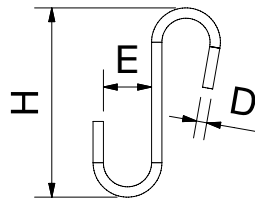

H	E	D	✓	Gr	Barcode	€
---	---	---	---	----	---------	---

60	16	3	10	40	9200606022502	4,60
----	----	---	----	----	---------------	-------------

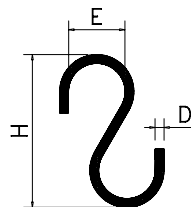

80	30	5	10	230	9200607022702	7,30
----	----	---	----	-----	---------------	-------------

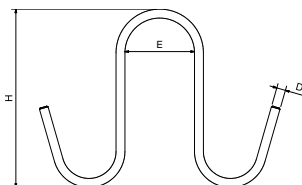

100	39	5	1	56	022438	2,07
-----	----	---	---	----	--------	-------------

160	39	5	1	76	022440	2,17
-----	----	---	---	----	--------	-------------

Ganchos jamoneros
Ham hooks
Crochets à jambon



H E D ✓ Gr €

		80	10	5	12	276	275233	12,00
--	--	----	----	---	----	-----	--------	--------------

		56	6	1	30	022602		17,60
--	--	----	---	---	----	--------	--	--------------

Gancho de varilla multifunción
Multifunctional rod hook
Crochet à barre multifonctionnel

H E D ✓ Gr €







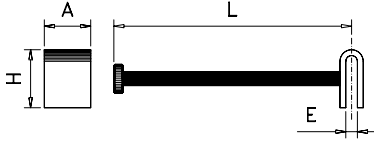

		120	45	5	20	40	022510	22,00
--	--	-----	----	---	----	----	--------	--------------

		142	16	5	1	55	211920	0,90
--	--	-----	----	---	---	----	--------	-------------

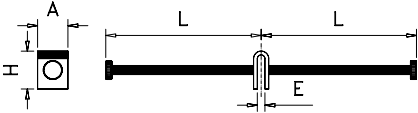
		115	13	4	1	29	022520	0,61
--	--	-----	----	---	---	----	--------	-------------

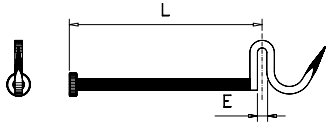

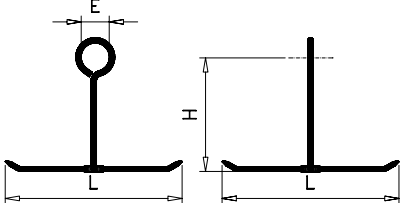
Ganchos salchicheros

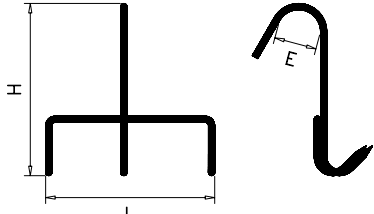
Sausage hooks
Crochets à saucisses

		L	A	H	E	Gr	Barcode	€			
		200	40	50	10	320	022802	31,00			
		300	40	50	10	415	022804	41,00			
		200	40	50	10	505	023002	63,00			
		300	40	50	10	685	023004	75,00			
		200				8	120	023202	41,00		
		215					145	40	170	023402	28,00
		130					170	39	80	023602	25,00

Gancho giratorio

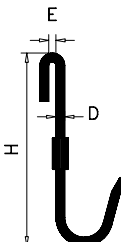
Revolving hook
Crochet tournant

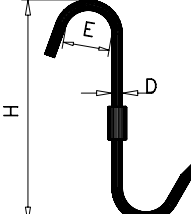
		H	E	D	Gr	Barcode	€
		280	18	12	380	422202	21,50
		240	56	10	260	422402	14,00

Gancho de arrastre

Pulling hook
Crochet d'entraînement

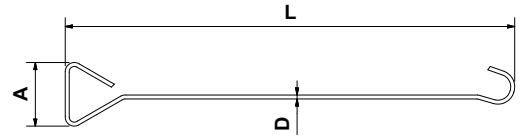

L	A	D	Gr	Barcode	€
760	107	7	301	023702	12,00

Barra mural con ganchos

Wall mounted rack with hooks
Barre dents de loup



Caractéristiques:
Barre de 40x8 mm.
Barre polie des 4 côtés.
Crochets amovibles.
Possibilité de mettre et enlever des crochets.
Deux supports robustes pour la fixation au mur.

Características:

Pletina de 40x8 mm.
Pletina pulida a las cuatro caras.
Ganchos movibles.
Posibilidad de añadir y quitar ganchos.
Dos robustos soportes para la sujeción a pared.

Characteristics:

Bar of 40x8 mm.
Polished on four sides.
The hooks can be positioned.
Possibility of removing or adding hooks.
Wall fixation by 2 solid brackets.

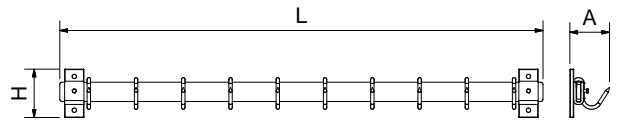

Gancho adicionales
Additional hooks
Crochets supplémentaires

H	E	D	Barcode
60	9	7	9200605022229

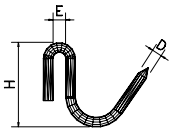

L	A	H	Nº Ganchos Hooks Crochets	Kg	Barcode	€
1.000	90	100	10	3,00	024220	109,00
1.500	90	100	10	4,00	024222	125,00

Kit para colgar utensilios

Tool-holder kit
Kit pour suspendre outils

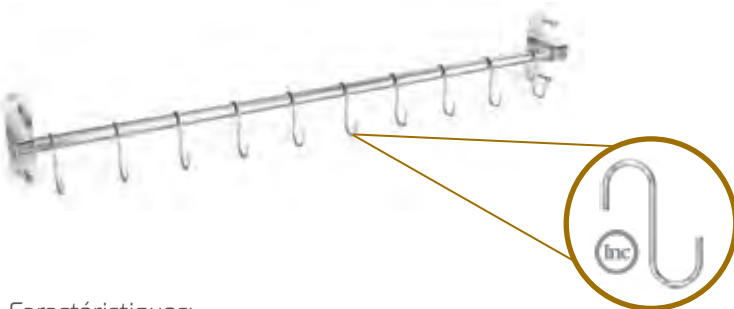

Caractéristiques:
Construit tout en acier inox.
Grande solidité.
Pourvu avec 10 crochets (9200606022502).
Il libère de l'espace sur le dessus.
Possibilité de l'utiliser comme porte-serviette ou porte-couvercles de bacs et pots.
Vis et ancrages pour fixation au mur inclus.

Características:

Construido totalmente en acero inoxidable.
Gran resistencia.
Provisto de 10 ganchos (9200606022502).
Incluye tornillos y tacos para fijar a la pared.
Libera superficie de trabajo en la encimera.
También se puede usar como toallero o para colgar las tapas de las cubetas y las ollas.

Characteristics:

Totally made in stainless steel.
High solidity.
Provided with 10 hooks (9200606022502).
It saves room on the worktop.
It also can be used as a towel rail or to hold the lids of tanks and pots.
Bolts and rawlplugs to fix onto the wall included.

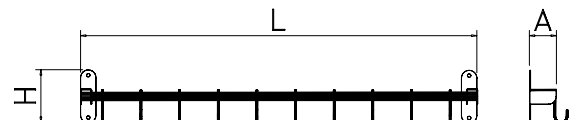

Gancho adicionales
Additional hooks
Crochets supplémentaires

H	E	D	Barcode
60	16	3	9200606022502

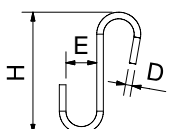

L	A	H	Nº Ganchos Hooks Crochets	Kg	Barcode	€
750	50	100	10	0,50	020102	37,00

Tochos de hierro cincado rosca métrica

Zinc-plated thick iron rods and metric threads
Goujons en fer zingué à filetage métrique

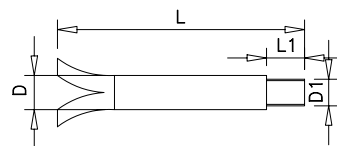

L	D	L1	D1	Gr	Barcode	€
150	18	20	M14	205	029802	12,00
200	18	20	M14	300	029804	14,00
250	18	20	M14	400	029806	15,00

Soportes murales para tubo

Wall supports for round tube
Supports muraux pour tube

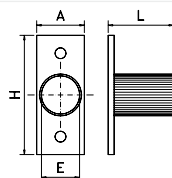

L	A	H	E	Gr	Barcode	€
45	40	100	30	190	026202	27,00
45	40	100	38	200	026204	27,00

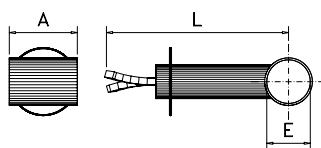

130	60	30	218	026402	74,00
130	60	38	233	026404	74,00
180	60	30	248	026406	80,00
180	60	38	263	026408	80,00
230	60	30	313	026410	86,00
230	60	38	328	026412	86,00

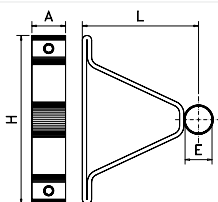

145	40	200	30	840	026602	85,00
149	40	200	38	855	026604	85,00
245	40	290	30	1.285	026606	99,00
249	40	290	38	1.300	026608	99,00

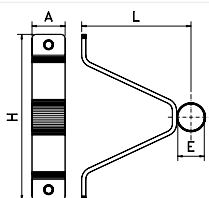

140	40	200	30	540	026802	60,00
144	40	200	38	550	026804	60,00
240	40	290	30	845	026806	75,00
244	40	290	38	855	026808	75,00

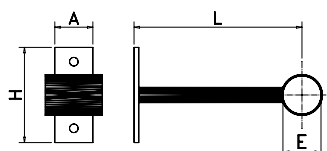











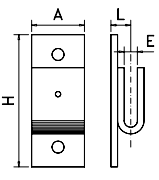

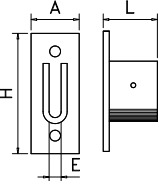
50	40	100	30	220	027002	48,00
50	40	100	38	280	027004	48,00
100	40	100	30	295	027006	51,00
100	40	100	38	310	027008	51,00
150	40	100	30	370	027010	57,00
150	40	100	38	385	027012	57,00
200	40	100	30	445	027014	61,00
200	40	100	38	460	027016	61,00

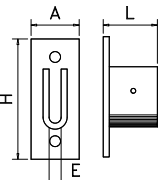
Soportes murales para pletina

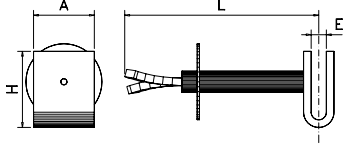
Wall supports for flat bar
Supports muraux pour barre

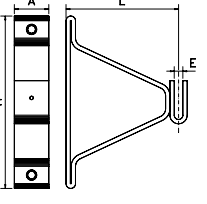
L A H E Gr  €

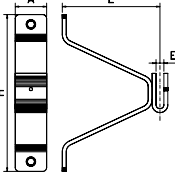

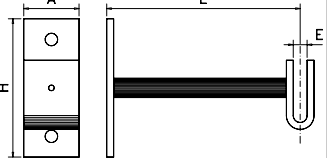
		18 40 100 10 345 024402 27,00
		45 40 100 10 345 024602 27,00
		45 40 100 10 345 024604 27,00
		130 40 50 10 320 024802 74,00
		180 40 50 10 350 024804 80,00
		230 40 50 10 455 024806 86,00
		140 40 200 10 975 025002 85,00
		240 40 290 10 1.385 025004 99,00
		135 40 200 10 645 025202 60,00
		235 40 290 10 935 025204 75,00
		50 40 100 10 325 025402 48,00
		100 40 100 10 400 025404 51,00
		150 40 100 10 475 025406 57,00
		200 40 100 10 550 025408 72,00

Cadena eslabón largo según norma DIN 763 ø5 A4

Long link chain according to DIN 763 ø5 A4
Chaîne à maillons longs selon DIN 763 ø5 A4

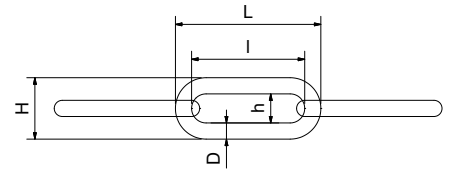

Precio 1 m.
1 m. price
Prix 1 m.

L	I	H	h	D	Gr	Barcode	€
45	35	19	9	5	420	420202	8,00

Plafones para exposición de embutidos

Sausage display boards
Panels d'exposition pour charcuterie

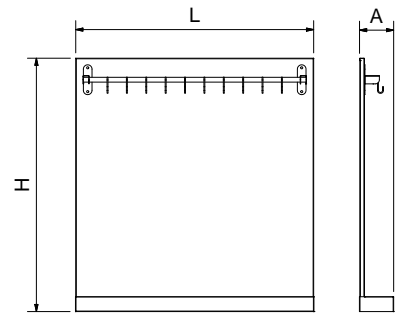

Gancho opcional 9200606022502
Optional hook 9200606022502.
Crochet optionnel 9200606022502.



46

L	A	H	✓	Kg	Barcode	€
800	115	850	10	6,22	024202	195,00
1.000	115	850	10	7,60	024204	270,00
1.500	115	850	10	11,26	024206	290,00

Cartelas abatibles para estantes murales

Hinged brackets for wall shelves
Consoles battante pour d'étagères murale



***HASTA 100 Kg
por cartela**

Maximum load per
bracket 100 Kgs.
Charge maximale par
console de 100 Kgs.

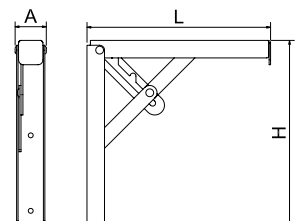

Acoplar a estante inox
Coupled to stainless steel shelves
Accouplé aux étagères en acier
inoxydable

013204 **28,00**

Acoplar a estante fibra
Coupled to polyethylene shelves
Accouplé aux étagères en polyéthylène

013202 **7,00**

L	A	H	Kg	Barcode	€
300	30	210	0,40	421254	42,50

Tirantes de techo

Ceiling rods
Tringles de plafond

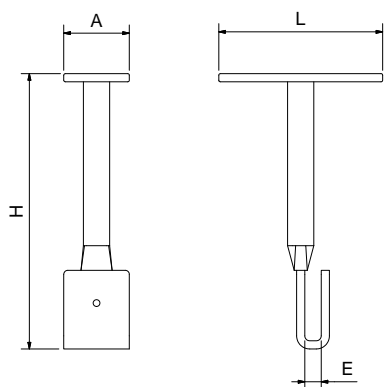

H	A	L	E	Gr	Barcode	€
100	40	100	10	360	025602	68,00
150	40	100	10	380	025604	71,00
200	40	100	10	400	025606	75,00
250	40	100	10	420	025608	77,00
300	40	100	10	440	025610	79,00
350	40	100	10	460	025612	84,00
400	40	100	10	480	025614	86,00
450	40	100	10	500	025616	87,00
500	40	100	10	520	025618	91,00
550	40	100	10	540	025620	93,00
600	40	100	10	560	025622	96,00
650	40	100	10	580	025624	100,00
700	40	100	10	600	025626	101,00
750	40	100	10	620	025628	105,00
800	40	100	10	640	025630	107,00
850	40	100	10	660	025632	111,00
900	40	100	10	680	025634	114,00
950	40	100	10	690	025636	117,00
1.000	40	100	10	695	025638	120,00



Tirantes de techo con varilla roscada

Ceiling rods with thread
Tringles de plafond avec filetage

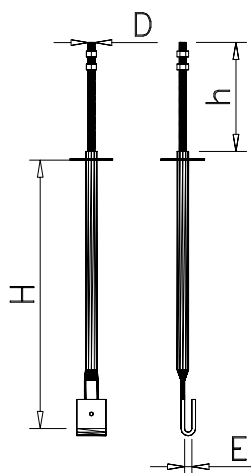

H	h	E	D	Gr	Barcode	€
100	150	10	M14	410	025802	62,00
150	150	10	M14	430	025804	64,00
200	150	10	M14	450	025806	68,00
250	150	10	M14	470	025808	70,00
300	150	10	M14	490	025810	72,00
350	150	10	M14	510	025812	76,00
400	150	10	M14	530	025814	79,00
450	150	10	M14	550	025816	79,00
500	150	10	M14	570	025818	82,00
550	150	10	M14	590	025820	84,00
600	150	10	M14	600	025822	87,00
650	150	10	M14	650	025824	90,00
700	150	10	M14	700	025826	93,00
750	150	10	M14	750	025828	95,00
800	150	10	M14	800	025830	97,00
850	150	10	M14	850	025832	100,00
900	150	10	M14	900	025834	103,00
950	150	10	M14	950	025836	106,00
1.000	150	10	M14	1.000	025838	108,00

Tirantes de techo para tubo

Ceiling rods for round tube
Tringles de plafond pour tube

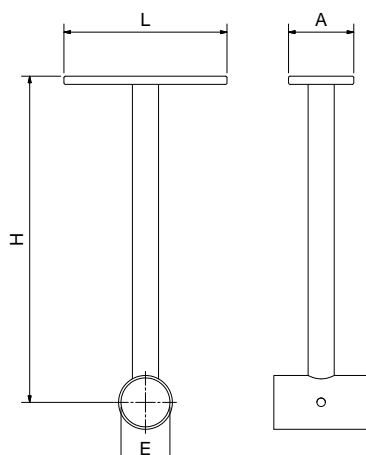

H	A	L	E	Gr	Barcode	€
100	40	100	30	300	027202	68,00
			38	320	027204	
150	40	100	30	330	027206	71,00
			38	350	027208	
200	40	100	30	360	027210	75,00
			38	380	027212	
250	40	100	30	390	027214	77,00
			38	410	027216	
300	40	100	30	420	027218	79,00
			38	440	027220	
350	40	100	30	450	027222	84,00
			38	470	027224	
400	40	100	30	480	027226	86,00
			38	500	027228	
450	40	100	30	510	027230	87,00
			38	530	027232	
500	40	100	30	540	027234	91,00
			38	560	027236	
550	40	100	30	570	027238	93,00
			38	590	027240	
600	40	100	30	600	027242	96,00
			38	620	027244	
650	40	100	30	630	027246	100,00
			38	650	027248	
700	40	100	30	660	027250	103,00
			38	680	027252	
750	40	100	30	690	027254	105,00
			38	710	027256	
800	40	100	30	720	027258	107,00
			38	740	027260	
850	40	100	30	750	027262	111,00
			38	770	027264	
900	40	100	30	780	027266	114,00
			38	800	027268	
950	40	100	30	810	027270	117,00
			38	830	027272	
1.000	40	100	30	840	027274	120,00
			38	860	027276	

Tirantes de techo para tubo con varilla roscada

Ceiling rods with thread for round tube

Tringles de plafond avec filetage pour tube

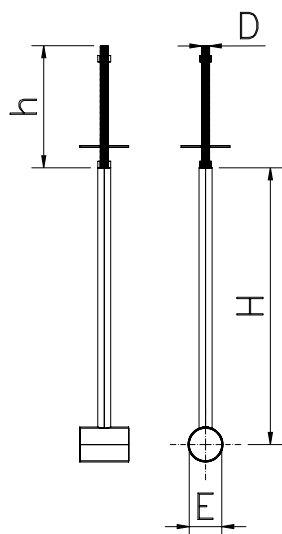

H	h	D	E	Gr	Barcode	€
100	150	M14	30	350	027402	62,00
			38	370	027404	
150	150	M14	30	380	027406	64,00
			38	400	027408	
200	150	M14	30	410	027410	68,00
			38	430	027412	
250	150	M14	30	440	027414	70,00
			38	460	027416	
300	150	M14	30	470	027418	72,00
			38	490	027420	
350	150	M14	30	500	027422	76,00
			38	520	027424	
400	150	M14	30	530	027426	78,00
			38	550	027428	
450	150	M14	30	560	027430	79,00
			38	580	027432	
500	150	M14	30	590	027434	82,00
			38	610	027436	
550	150	M14	30	620	027438	84,00
			38	640	027440	
600	150	M14	30	650	027442	87,00
			38	670	027444	
650	150	M14	30	680	027446	90,00
			38	700	027448	
700	150	M14	30	710	027450	93,00
			38	730	027452	
750	150	M14	30	740	027454	95,00
			38	760	027456	
800	150	M14	30	770	027458	97,00
			38	790	027460	
850	150	M14	30	800	027462	100,00
			38	820	027464	
900	150	M14	30	830	027466	103,00
			38	850	027468	
950	150	M14	30	860	027470	106,00
			38	880	027472	
1.000	150	M14	30	890	027474	108,00
			38	910	027476	

Sujeciones de hierro para tirante

Iron fasteners for rod
Fixations de fer pour tringle

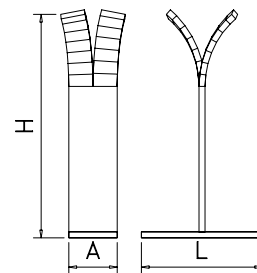

H	A	L	Gr	Barcode	€
100	40	100	240	028402	25,00
200	40	100	360	028404	26,00
300	40	100	480	028406	27,00
400	40	100	600	028408	28,00
500	40	100	720	028410	29,00
600	40	100	840	028412	30,00
700	40	100	960	028414	32,00
800	40	100	1.080	028416	33,00
900	40	100	1.200	028418	34,00
1.000	40	100	1.320	028420	35,00

Garras galvanizadas para tirantes

Galvanized splayed rod clamp
Griffes galvanisées pour tringle

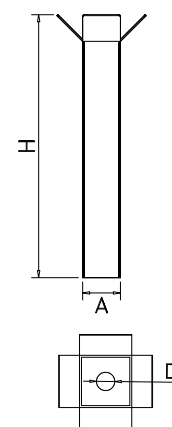

H	A	D	Gr	Barcode	€
100	40	M14	170	028602	25,00
200	40	M14	340	028604	26,00
300	40	M14	510	028606	27,00
400	40	M14	680	028608	28,00
500	40	M14	850	028610	29,00
600	40	M14	1.020	028612	30,00
700	40	M14	1.190	028614	32,00
800	40	M14	1.360	028616	33,00
900	40	M14	1.530	028618	34,00
1.000	40	M14	1.700	028620	35,00

Tirante para balanzas regulable

Adjustable rod for hanging scales
Tringle réglable pour balances suspendues



Características:

Diseñado para adaptar la altura de la balanza a cada usuario.
La regulación se realiza de una manera fácil, rápida y segura, sin tener que descolgar o desenchufar la balanza.
Regulación 86 mm.
Para tubo de $\varnothing 38$ mm. arriba.
Casquillo de $\varnothing 40$ mm. en balanza.

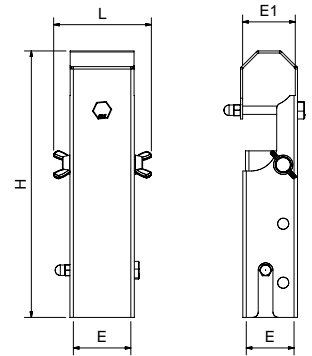

Characteristics:

Designed to adjust the hanging scale at the desired height.
The adjustment can be done in a quick, easy and safe way. You do not need to take down or unplug the scale.
Adjustment: 86 mm.
For upper tube of $\varnothing 38$ mm.
Scale ferrule of $\varnothing 40$ mm.

Caractéristiques:

Conçu pour régler la balance suspendue à la hauteur convenable.
L'ajustement peut être fait de manière simple, rapide et en toute sécurité. Vous n'avez pas besoin de décrocher ou de débrancher la balance.
Ajustement: 86 mm.
Pour tube supérieur de $\varnothing 38$ mm.
Virole d'échelle de $\varnothing 40$ mm.

H	L	E	E1	Gr	028250	€
192-234-277	70	$\varnothing 40$	$\varnothing 38$	500	028250	50,00

Tirante para colgar balanzas

Hanging rod for scales
Tringle de suspension pour balances

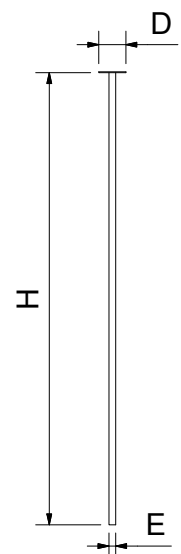

H	D	E	Gr	028262	€
2.000	120	30	600	028262	139,00

Tirantes para balanzas

Rods for scales
Tringles pour balances

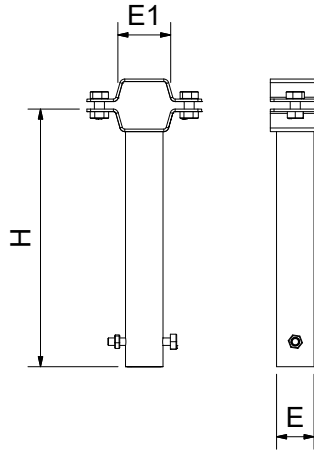

H	E	E1	Gr	Barcode	€
100	30	30	110	028202	74,00
		38	120	028204	
200	30	30	215	028206	78,00
		38	225	028208	
300	30	30	320	028210	82,00
		38	330	028212	
400	30	30	425	028214	87,00
		38	435	028216	
500	30	30	530	028218	95,00
		38	540	028220	
600	30	30	635	028222	100,00
		38	645	028224	
700	30	30	740	028226	104,00
		38	750	028228	
800	30	30	845	028230	107,00
		38	855	028232	
900	30	30	950	028234	116,00
		38	960	028236	
1.000	30	30	1.055	028238	120,00
		38	1.065	028240	

Defensa de esquina tubular 90°

Bumper bar for corner 90°
Pare-choc pour coin 90°



Características:

Desmontable.
Fabricadas en tubo de $\varnothing 48.3$ mm.
AISI 304.
Fijación mediante casquillos.

Characteristics:

Detachable.
Made with tube $\varnothing 48.3$ mm.
AISI 304.
Assembled by means of ferrules

Caractéristiques:

Détachable.
Fabriquées avec tube de $\varnothing 48.3$ mm.
AISI 304.
Fixation par bagues.

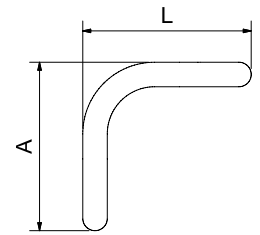
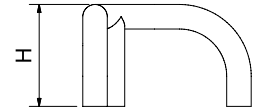

H	A	L	Gr	Barcode	€
220	340	340	1.150	425402	240,00

Soportes de suelo

Floor supports
Supports sur plancher

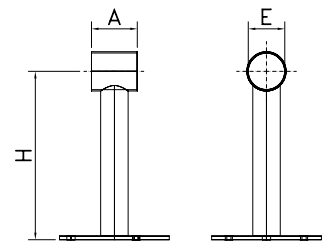
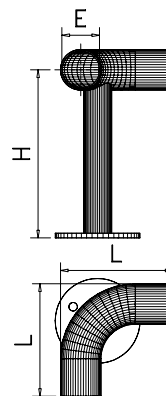

H	L	E	Gr	Barcode	€
200	90	30	695	029002	86,00
	210	38	990	029004	90,00
250	90	30	745	029006	90,00
	210	38	1.040	029008	95,00
300	90	30	795	029010	95,00
	210	38	1.090	029012	98,00

H	A	E	Gr	Barcode	€
200	50	30	600	028802	55,00
		38	630	028804	
250	50	30	650	028806	58,00
		38	680	028808	
300	50	30	700	028810	63,00
		38	730	028812	

Parking para carros de la compra

Shopping trolley bay
Parking pour caddies



Fabricado en acero inoxidable, este parking para carros de la compra es ideal para instalar en cualquier superficie que disponga de carros de la compra para el uso de sus clientes, ya sean pequeñas superficies de alimentación, supermercados, centros comerciales, etc.

Incorpora cadena de 500 mm para el anclaje del primer carro.

Made of stainless steel, this bay for shopping trolleys is ideal to be installed on any surface that has shopping carts ready to use for their customers, whether they are small food areas, supermarkets, shopping centers, etc.

It is provided with a 500 mm chain for securing the first trolley.

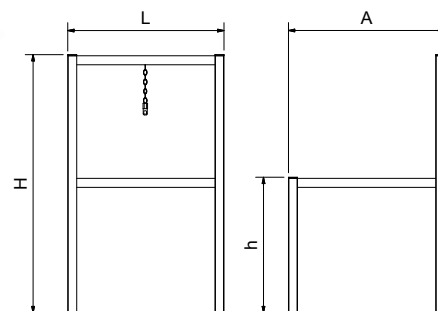

Fabriqué en acier inoxydable, ce parking pour caddies est idéal à installer sur toute surface dotée de caddies à l'usage de ses clients, qu'il s'agisse de petites aires de restauration, de supermarchés, de centres commerciaux, etc.

Il intègre une chaîne de 500 mm pour ancrer la première voiture.

L	A	H	h				€
695	695	1.140	602	1	7,50	081060	246,00
1.330	695	1.145	602	2	8,50	081062	299,00

Plaqueta

Plate
Plaque

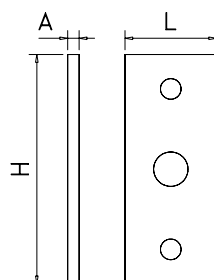

L	A	H			€
40	5	100	135	224602	11,00

Concepto Concept			€
Plaqueta soldada Soldered plate Plaque soudée		029604	30,00

Plaqueta redonda

Round plate
Plaque ronde

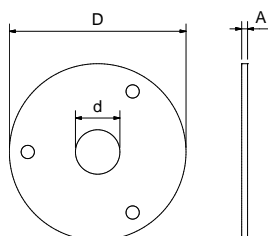

D	d	A			€
120	30	4	340	228806	10,00

Soporte jamón RT

Ham holder RT
Support jambon RT

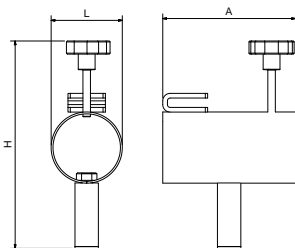

L	A	H	Gr	Barcode	€
75	140	220	800	041812	68,00

Útil para sujeción de jamones

Ham holder tool
Outil pour porter jambons

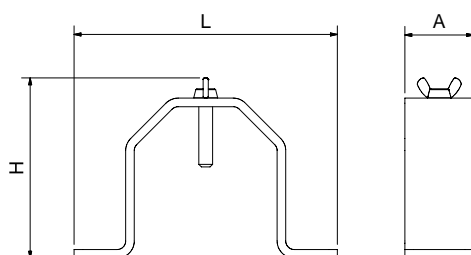

L	A	H	Gr	Barcode	€
153	40	105	400	024250	110,00

Tubos en escuadra

Round tube at right angle
Tube en cornière

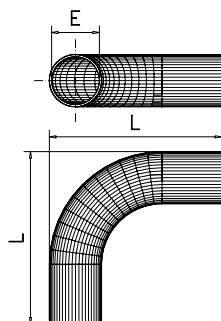

L	E	Gr	Barcode	€
90	30	195	429002	23,00
210	38	490	429004	25,00

Tubos en forma de "T"

T-shaped round tube
Tube dans "T"

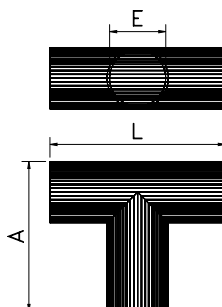

L	A	E	Gr	Barcode	€
110	70	30	160	425002	36,00
100	70	38	185	425004	49,00

Cruces para tubo

Round tube intersections
Intersections pour tube

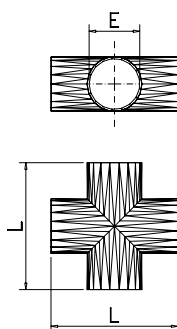

L	E	Gr	Barcode	€
112	30	210	425202	83,00
110	38	340	425204	76,00

" U " sencilla
Simple " U "
" U " simple

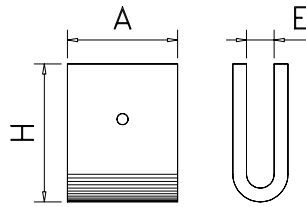

A	E	H	Gr	Barcode	€
40	10	50	155	029606	12,00

Concepto Concept Concept			Gr	Barcode	€
"U" sencilla soldada Soldered single "U" "U" simple soudée			029602		39,00



" U " en doble T
" U " in double T
" U " en double T

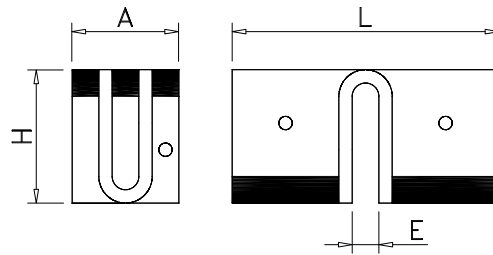

L	A	H	E	Gr	Barcode	€
100	40	50	10	445	029202	86,00

" U " en forma de T
" U " in T
" U " dans T

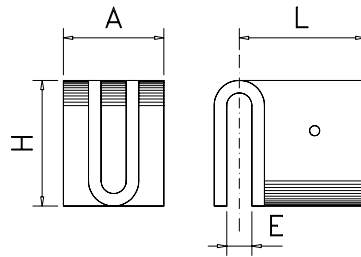

L	A	H	E	Gr	Barcode	€
50	40	50	10	295	029402	39,00

" U " mixta en forma de T
T-shaped mixed " U "
" U " mixte dans T

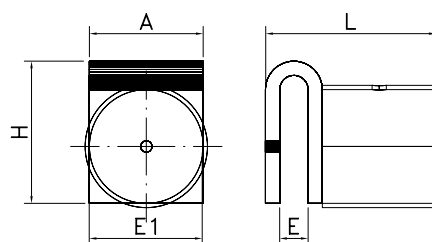

L	A	H	E	E1	Gr	Barcode	€
60	40	50	10	30	175	029302	43,00
60	40	50	10	38	180	029304	48,00

Gancho pesador

Weighing hook
Crochetspeseur



300 

Características:

Peso en Kg., lb. y JIN
Funciones: ON/OFF, Tara, fijación de peso automática
Indicador de batería
Desconexión automática
Pantalla retroiluminada
Nº de teclas: 3
Pilas necesarias (no incluidas): 2xAAA
Mosquetón de fijación superior y gancho abierto inferior.



Characteristics:

Weighing in Kg., lb and JIN
Functions: ON/OFF, Tare, Automatic weight-fixation
Battery indicator
Auto switch off
Backlighted display
Number of buttons: 3
Batteries required (non included): 2 x AAA
Upper carabiner and lower open hook included.

Caractéristiques:

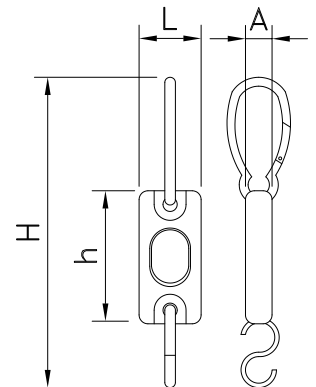
Poids en Kg., lb et JIN
Fonctions: ON/OFF, Tara, Fixation du poids automatique.
Témoin de batterie
Mise en veille automatique
Ecran retro-eclairé
Nombre de touches: 3
Piles requises (non incluses): 2 x AAA
Mousqueton supérieur et crochet inférieur ouvert inclus.





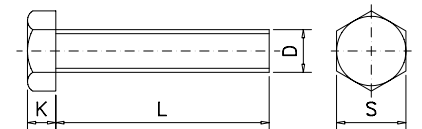

L	A	H	h				€
65	35	290	150	300	365	422604	65,00

Tornillos cabeza hexagonal rosca métrica

Bolts with hexagonal head and metric threads
Vis de tête hexagonale à filetage métrique



L	D	S	K			€
16	M4	7	2,8	3,0	421002	0,10
35	M4	7	2,8	6,0	421003	0,15
8	M5	8	3,5	0,7	421004	0,11
12	M5	8	3,5	1,0	421006	0,12
12	M6	10	4,0	3,0	421007	0,13
40	M6	10	4,0	8,0	421008	0,20
50	M6	10	4,0	9,0	421010	0,23
12	M8	13	5,3	7,0	421012	0,20
16	M8	13	5,3	8,0	421014	0,23

L	D	S	K			€
25	M8	13	5,3	11,0	421016	0,25
40	M8	13	5,3	15,0	421018	0,28
50	M8	13	5,3	18,0	421020	0,35
60	M8	13	5,3	21,0	421022	0,44
80	M8	13	5,3	27,0	421024	0,67
100	M8	13	5,3	33,0	421026	0,80
70	M10	17	6,4	40,0	421028	0,71
80	M10	17	6,4	44,0	421030	0,75
100	M10	17	6,4	56,0	421032	0,78

Tornillos barraqueros con embellecedor

Blind nut with self-tapping bolts
Ecroû de trou borgne à vis à bois

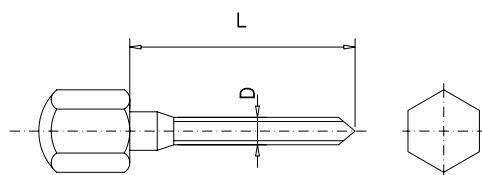

L	D	Gr	Barcode	€
40	6	20	029702	2,80
65	10	30	029704	23,00



Tirafondos cabeza hexagonal

Bolts with hexagonal head
Tire-fond de tête hexagonale

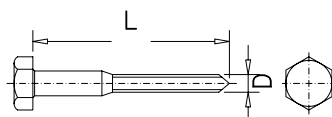

L	D	Gr	Barcode	€
40	6	10	421034	0,30
55	6	15	421035	0,50
60	8	20	421036	0,90
70	6	20	421033	0,64

Tornillos rosca chapa

Self-tapping screws
Vis filetage tôle

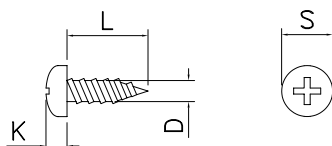

L	D	S	K	Gr	Barcode	€
10	3,5	7,0	2,00	1,0	421042	0,08
19	3,9	7,5	2,80	2,0	421039	0,10
22	5,5	10,5	4,10	6,0	421037	0,20
22	4,8	9,5	3,55	3,0	421038	0,15
32	3,9	7,5	2,80	2,2	421040	0,12

Tornillo cabeza allen rosca métrica

Screw with allen head and metric thread
Vis avec tête allen et fillet métrique

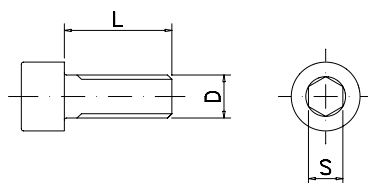

L	D	S	Gr	Barcode	€
12	M6	5	12	421043	0,25
25	M10	8	25	421044	0,50

Tacos de plástico nylon

Nylon-plastic plug
Cheville en plastic-nylon

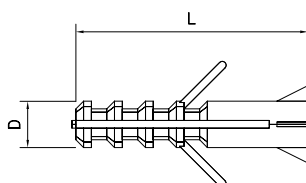

D	L	Barcode	€
6	30	409822	0,11
8	40	409824	0,13
10	50	409826	0,32

Tornillo pasante con tuerca y contratuerca rosca métrica

Screw with nut and conternut with metric threads
Vis perçante avec écrou et cotre-écrou à filetage métrique

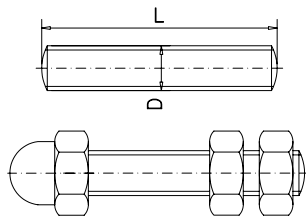

L	D	Gr	Barcode	€
200	M8	80	029502	7,00

Tornillo cabeza mariposa tipo americano

American shape wing screw
Vis à oreilles type américain

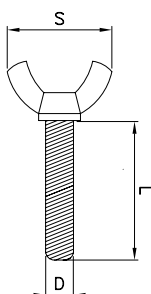

S	L	D	Gr	Barcode	€
30	25	8	17,00	421047	1,50
30	50	8	17,26	421046	1,60

Taco galvanizado para techo tipo balancín

Galvanized ceiling rocker plug
Cheville galvanisé pour toit modèle balancier

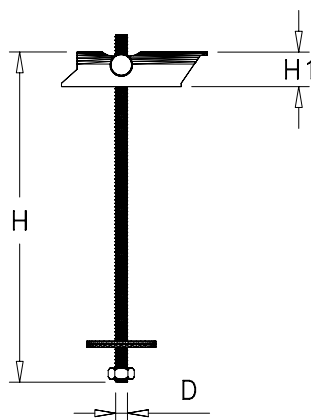

H	H1	D	Gr	Barcode	€
200	20	M8	135	421422	16,00

Varillas roscadas rosca métrica

Rod with metric threads
Tige spirale à filetage métrique

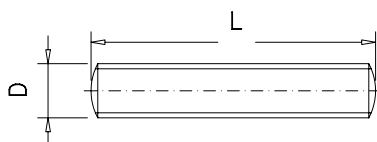

L	D	Gr	Barcode	€
1.000	M8	310	421202	5,95
1.000	M10	495	421204	6,00

Embellecedor para tocho

Blind nut and metric threads
Ecrou de trou borgne à filetage métrique

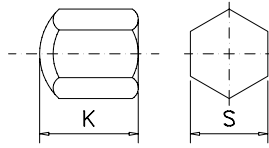

D	S	K	Gr	Barcode	€
M14	22	25	50	029902	5,50



Tuercas ciegas hexagonales rosca métrica

Hexagonal acorn nuts with thread
Ecrrous borgne hexagonale à filetage métrique

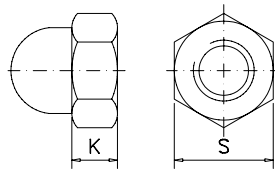

D	S	K	Gr	Barcode	€
M4	7	3,5	1	421064	0,27
M5	8	3,5	2	421066	0,30
M8	13	5,3	8	421070	0,56
M10	17	6,5	18	421072	1,12
M14	22	8,8	35	421076	5,11

Tuerca ciega hexagonal con autoseguro

Hexagon self-locking nut with cup
Ecrou borgne hexagonal avec auto-sécurité

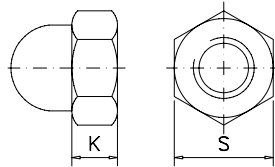

D	S	K	Gr	Barcode	€
M6	10	5	4	421068	0,79

Tuercas hexagonales rosca métrica

Hexagonal nuts with thread
Ecrrous hexagonale à filetage métrique

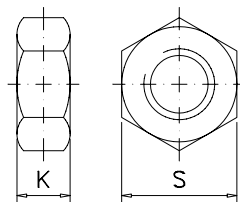

D	S	K	Gr	Barcode	€
M4	7	2,8	0,7	421050	0,12
M5	8	3,5	1	421052	0,36
M6	10	4,0	2	421054	0,58
M8	13	5,3	4	421056	0,12
M10	17	6,5	10	421058	0,26
M12	19	10,0	16	421060	0,34
M14	22	8,8	22	421062	0,39

Tuerca hexagonal rosca metrica con autoseguro

Hexagonal nut with metric thread and lock
Ecrou hexagonale autobloquant à filletage métrique

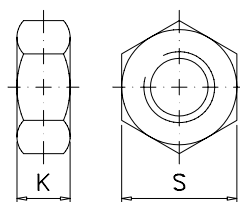

D	S	K	Gr	Barcode	€
M5	8	5,0	1	421078	0,44
M6	10	6,0	2	421080	0,66

Tuerca mariposa tipo americano

American shape wing nut
Écrou à oreilles type américain

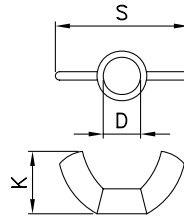

S	K	D	Gr	Barcode	€
30	15	M8	5,6	421082	0,49

Remaches tubulares

Tubular rivets
Rivetages tubulaires

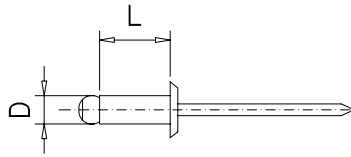

L	D	Gr	Barcode	€
10	3,2	1	421230	0,19
8	4,8	2	421233	0,39

Bisagra de piano inox

Piano hinge
Charnière de piano



L	A	Gr	Barcode	€
1.820	38	1.200	421250	99,00

Arandelas

Plain washer
Rondelle plate



Typo	D	D ext.	Gr	Barcode	€
Plana Plane Plain	M6	12,0	1,0	421215	0,05
	M8	16,0	2,0	421216	0,06
	M10	20,0	3,0	421218	0,17
	M12	19,5	2,7	421206	0,09
	M20	37,0	14,0	421220	0,44
Especial Special Special	M8	24,0	5,0	421221	0,15
	M10	30,0	11,0	421223	0,26
	M12	30,0	25,0	421208	1,00
	M20	60,0	64,0	421222	1,00
Grower Grower Grower	M4	6,2	0,2	421210	0,03
	M5	9,2	0,3	421212	0,03
	M8	14,8	1,0	421214	0,06
	M10	18,1	2,5	421213	0,08



TAJOS

CHOPPING BLOCKS AND FIBRE BOARDS
BILLOTS DE DÉCOUPE ET PLAQUES

NOVEDADES
NEWS
NOUVEAUTÉS



77





Detalle de portacuchillos de chapa y papelera adosados a tajo de troceo.

Detail of knife-holder in stainless steel sheet and wastepaper bin fixed to chopping block.
 Détail de porte-couteaux en plaque et de corbeille à papier adapté au billot.

Manufacturing characteristics of all our blocks:

Frame constructed from stainless steel.

Shelves made from acoustically treated stainless steel sheet, with no wood fitted internally.

Adjustable legs for a higher stability on any surface

Optionally, the following accessories can be installed:



Drawers	492
Knives disinfectants	370
Lateral wastepaper bin	394
Knife holders	136
Wheels	496
Lateral waste receptacle for scraps	74
Antivibrator cover for adjustable blocks	499
Coloured fibres	75

Características de fabricación de todos nuestros tajos:

Bastidor construido en tubo de acero inoxidable.

Entrepaño en chapa de acero inoxidable insonorizado y sin madera pegada en su interior.

Pies regulables para una mayor estabilidad en cualquier tipo de suelo.

Opcionalmente se pueden instalar los siguientes accesorios:



Cajones	492
Esterilizadores de cuchillos	370
Papelera lateral	394
Portacuchillos	136
Ruedas	496
Tolva lateral evacuación de desperdicios	74
Funda antivibradora para taco regulable	499
Fibras de colores	75



Caractéristiques de fabrication de tous nos billots:

Châssis fabriqué en tube d'acier inoxydable.

Tablettes fabriquées en plaque d'acier inoxydable insonorisées et sans bois collé à l'intérieur.

Pieds réglables pour une plus grande stabilité sur n'importe quelle surface.

Optionnellement on peut installer les suivantes accessoires:



Tiroirs	492
Désinfectants de couteaux	370
Corbeille à papier latéral	394
Porte couteaux	136
Roues	496
Trémie latéral d'évacuation des déchets	74
Base anti-vibrateur pour taquets réglables	499
Plaques de couleurs	75



Detalle de rueda de acero inoxidable con freno acoplada a pata de tajo de troceo.

Detail of wheel in stainless steel with brake fixed to chopping block leg.
 Détail de roue en acier inoxydable avec frein installé dans pied de billot.



Detalle de pata con pie regulable con funda antivibradora.

Detail of adjustable feet with antivibrator cover.
 Détail de pie réglable avec base anti-vibrateur.

Tajos de troceo de fibra lastrados

Weighted butcher blocks with polyethylene
Billots lestés en fibre



Características:

Sistema de lastrado que garantiza una mayor higiene.
Los tajos blindados y lastrados Fricosmos están especialmente diseñados para sustituir las mazas y tajos de madera, principalmente por las siguientes cualidades:
Fibra polietileno calidad P-500 de 50 mm de grosor.
Mayor peso, que evitará en gran medida el sonido y las vibraciones al ser golpeado, favoreciendo la estabilidad.

Characteristics:

Ballasting system that guarantees better hygiene.
The reinforced, weighted Fricosmos chopping blocks are especially designed to replace the wooden chopping blocks and boards mainly because of the following qualities:
P-500 quality and 50mm thick polyethylene fibre.
Its heaviness reduces noise and vibrations and keeps it steady.

Caractéristiques:

Système de lestage qui garantit une plus grande hygiène.
Les billots blindés et lestés Fricosmos sont spécialement préparés pour remplacer les troncs d'arbres et les billots en bois, grâce surtout à leurs qualités:
Plaque de polyéthylène qualité P-500 de 50 mm d'épaisseur.
Poids solide, qui évitera en grande mesure le bruit et les vibrations au moment de frapper, ce qui favorise la stabilité.



Es posible suministrarlos con fibra de diferente color. (Consultar)
There is the possibility of supplying them with other colours of fibre. (Ask for it)
Possibilité d'en fournir avec autres couleurs de fibre. (Demandez)

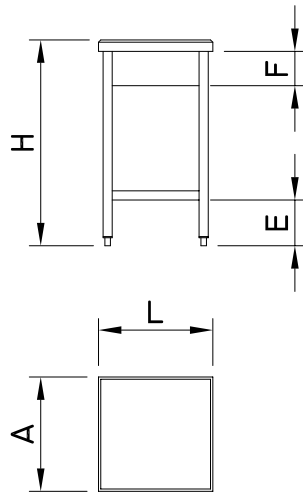

L	A	H	F	E		Kg		€
400	400	900	145	200		31,0	030102 030152	389,00
450	450	900	145	200		38,0	030104 030154	441,00
500	500	900	145	200		41,0	030106 030156	474,00
600	400	900	145	200		39,0	030108 030158	505,00
700	500	900	145	200		51,0	030110 030160	631,00
1.000	500	900	145	200		67,0	030112 030162	964,00

Tajos de troceo de fibra con faldón

Butcher blocks with polyethylene and skirt
Billots en fibre avec support à pan



Es posible suministrarlos con fibra de diferente color. (Consultar)
There is the possibility of supplying them with other colours of fibre. (Ask for it)
Possibilité d'en fournir avec autres couleurs de fibre. (Demandez)

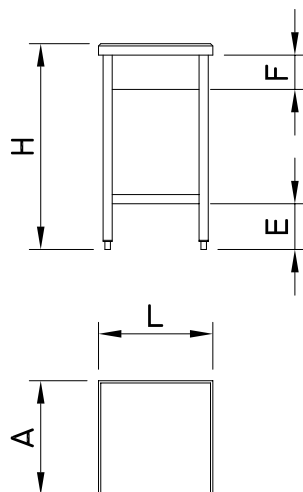

Características:

Los tajos de fibra Fricosmos incorporan de serie polietileno calidad P-500 de 50 mm de grosor.

Characteristics:

Fricosmos fibre blocks come as standard with P-500 quality and 50 mm thick polyethylene.

Caractéristiques:

Les billots en fibre Fricosmos incorporent de série polyéthylène de qualité P-500 de 50 mm d'épaisseur.

L	A	H	F	E		Kg		€
400	400	900	145	200		15,1	030302 030352	341,00
450	450	900	145	200		17,8	030304 030354	370,00
500	500	900	145	200		20,9	030306 030356	381,00
600	400	900	145	200		20,3	030308 030358	410,00
700	500	900	145	200		27,3	030310 030360	500,00
1.000	500	900	145	200		36,9	030312 030362	603,00

Tajo de troceo de fibra serie GE

Butcher blocks with polyethylene, GE series
Billot en fibre, modèle GE



Características:

Este tajo incorpora de serie polietileno calidad P-500 de 70 mm de grosor.

Characteristics:

Fricosmos fibre blocks come as standard with P-500 quality and 70 mm thick polyethylene.

Caractéristiques:

Les billots en fibre Fricosmos incorporent de série polyéthylène de qualité P-500 de 70 mm d'épaisseur.



040602 86,00 136

Portacuchillos para adosar con envoltente.

Mounted knife holder with casing
Porte-couteaux pour adosar avec enveloppant

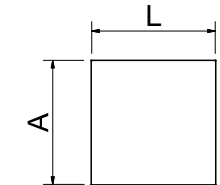
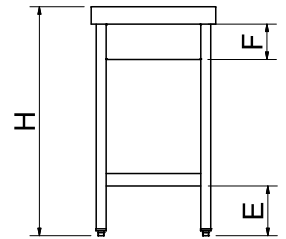
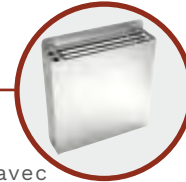

L	A	H	F	E		Kg		€
500	500	920	145	200		25,90	032008	456,00
500	500	920	145	200		25,90	032010	456,00
500	500	920	145	200		25,90	032012	456,00

Tajo especial barbacoa

Butcher block, especially for barbecues
Billot spécial pour barbecues



Contenido:

- 1 Soporte de acero inoxidable con faldón y entrepaño.
- 1 Fibra de polietileno alta densidad. Dimensiones 600x400x50 mm.
- 1 Estante de apoyo de 325x325 mm, de acero inoxidable
- 1 Kit para utensilios de acero inoxidable con 10 ganchos.
- 1 Cestillo porta-objetos de 105x105x145 mm.
- 1 Adaptador para contenedor de desperdicios, de acero inoxidable.
- 1 Contenedor de desperdicios de 26 lbs.
- 2 Ruedas giratorias sin freno, de acero inoxidable y superficie de rodadura de nylon.
- 2 Ruedas giratorias con freno, de acero inoxidable y superficie de rodadura de nylon.

Content:

- 1 frame of stainless steel with fringe and shelf.
- 1 high density polyethylene board, dimensions 600x400x50 mm.
- 1 stainless steel shelf for support of 325x325 mm.
- 1 tool holder kit in stainless steel with 10 hooks.
- 1 tool holder basket of 105x105x145 mm.
- 1 waste bin container adaptor in stainless steel.
- 1 waste bin container of 26 liters
- 2 revolving wheels in stainless steel, without brakes and rolling surface in nylon.
- 2 revolving wheels in stainless steel, with brakes and rolling surface in nylon.

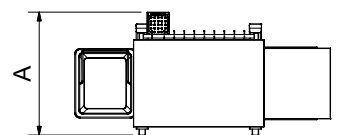
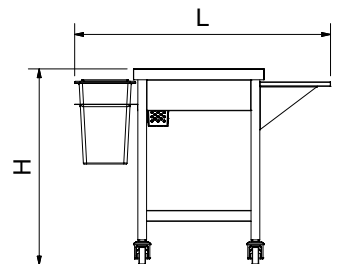

Contenu:

- 1 châssis en acier inoxydable avec support à pan et étage.
- 1 plaque en polyéthylène d'haute densité et dimensions 600x400x50 mm
- 1 étagère en acier inoxydable de 325x325 mm pour appui des objets
- 1 kit pour suspendre outils en acier inoxydable avec 10 crochets.
- 1 panier pour suspendre objets de 105x105x145 mm
- 1 adaptateur en acier inoxydable pour conteneur à ordures.
- 1 conteneur à ordures de 26 litres
- 2 rouelles pivotantes en acier inoxydable, sans frein et surface roulante en nylon.
- 2 rouelles pivotantes en acier inoxydable, avec frein et surface roulante en nylon.



Es posible suministrarlos con fibra de diferente color. (Consultar)

There is the possibility of supplying them with other colours of fibre. (Ask for it)
Possibilité d'en fournir avec autres couleurs de fibre. (Demandez)

L	A	H	Kg		€
1.175	565	900	28,5	032002	656,00

Tajos de troceo madera con faldón

Butcher blocks with wood and skirt
Billots en bois avec support inox

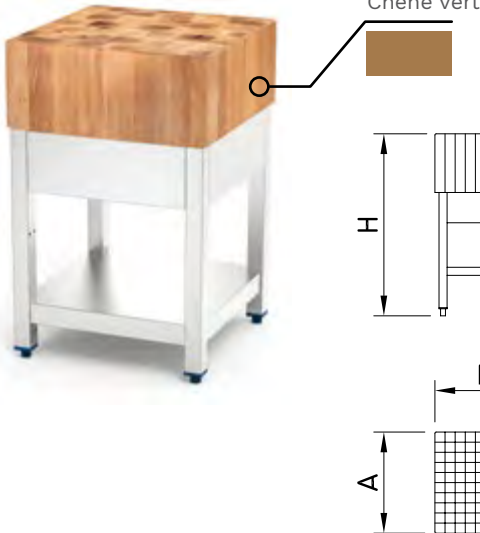
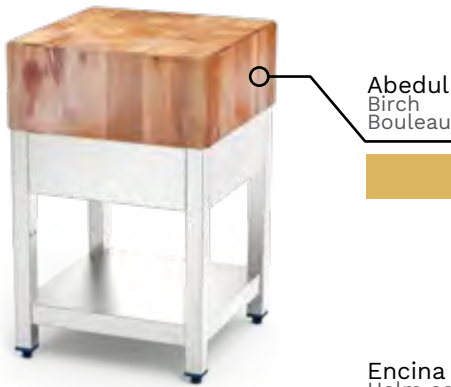

Características:

Los tajos de madera Fricosmos incorporan de serie una maza construida con tacos de madera de abedul o encina de 250 mm de espesor.

Characteristics:

Fricosmos wooden blocks come as standard with wooden mass constructed with blocks of birch or holm oak 250 mm thick.

Caractéristiques:

Les billots en bois Fricosmos incorporent de série un bloc fabriqué avec morceaux de bois bouleau ou de chêne vert de 250 mm d'épaisseur.

L	A	H	F	E		Kg		€
400	400	900	145	150		36	031102	419,00
						46	031502	591,00
450	450	900	145	150		45	031104	462,00
						58	031504	684,00
500	500	900	145	150		54	031106	512,00
						69	031506	758,00
600	400	900	145	150		52	031108	512,00
						67	031508	758,00
700	500	900	145	150		75	031110	620,00
						96	031510	962,00
1.000	500	900	145	150		105	031112	945,00
						136	031512	1.324,00

Tajos de troceo madera y fibra con faldón

Butcher blocks with polyethylene, wood and skirt
Billots en bois et en fibre avec support inox



Características:

Los tajos de madera y fibra Fricosmos incorporan de serie polietileno calidad P-500 de 50 mm de grosor y maza construida con tacos de madera de abedul de 200 mm de espesor.

Characteristics:

Fricosmos wooden and fibre chopping blocks come as standard with P-500 quality and 50 mm thick polyethylene and wooden mass constructed with birch blocks of 200 mm thick.

Caractéristiques:

Les billots en bois et en fibre Fricosmos incorporent de série Polyéthylène qualité P-500 de 50 mm d'épaisseur et bloc fabriqué avec morceaux de bois bouleau de 200 mm d'épaisseur.

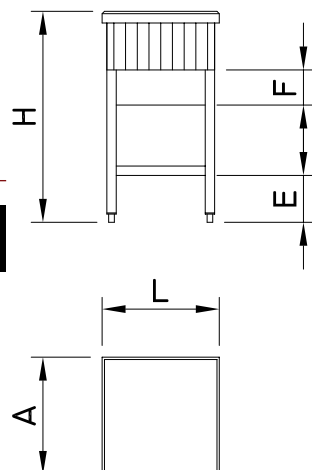

Es posible suministrarlos con fibra de diferente color. (Consultar)
There is the possibility of supplying them with other colours of fibre. (Ask for it)
Possibilité d'en fournir avec autres couleurs de fibre. (Demandez)

L	A	H	F	E		Kg		€
400	400	900	145	150		30,0	030702	465,00
							030752	
450	450	900	145	150		40,0	030704	573,00
							030754	
500	500	900	145	150		41,0	030706	597,00
							030756	
600	400	900	145	150		52,3	030708	606,00
							030758	
700	500	900	145	150		56,0	030710	703,00
							030760	
1.000	500	900	145	150		106,9	030712	1.121,00
							030762	

Tajo con sistema de elevación

Butcher block with lifting system
Billot avec système d'élévation



Tajo de corte fabricado en acero inoxidable que incorpora una maza de madera de abedul de 200 mm de espesor y una fibra de polietileno rojo de 50 mm de espesor.

Están diseñados especialmente para el corte de alimentos aportando resistencia y fiabilidad.

Este modelo además incorpora un sistema de elevación que permite regular la altura de la superficie de trabajo.

¿Por qué hemos diseñado un tajo que se pueda regular en altura? Nuestras premisas principales han sido: la ergonomía, la reducción de enfermedades laborales y de accidentes de trabajo.

Con esta utilidad, su personal, independientemente de su altura, podrá adaptar el centro de trabajo a las necesidades particulares, realizando su jornada diaria mucho más cómoda y segura, evitará malas posturas y en gran medida, posibles accidentes o lesiones. Este sistema se adapta perfectamente a suelos con caída o desnivel, estando la encimera siempre horizontal.

La regulación posible es de 200 mm hacia arriba o hacia abajo, siendo la altura mínima total de 805 mm y la máxima total de 1005 mm. Resistencia y durabilidad garantizada.

Structure made of stainless steel that incorporates a block of birch wood 200 mm thick and a red polyethylene fiber 50 mm thick. They are specially designed for food cutting providing strength and reliability. This model also incorporates a lifting system that allows to regulate the height of the work surface.

Why have we designed a butcher's block that can be adjusted in height? Our main principles have been: ergonomics and the reduction of occupational diseases and accidents at work.

With this utility, your staff, regardless of their height, can adapt the workplace to particular needs, making their daily work much more comfortable and safer, avoid bad postures and to a large extent, possible accidents or injuries. This system adapts perfectly to floors with fall or unevenness, being the countertop always horizontal.

The possible adjustment is 200 mm upwards or downwards, with a total minimum height of 805 mm and a total maximum height of 1005 mm. Strength and durability guaranteed.

Billot pour découpe fabriqué en acier inoxydable qui inclus un bloc en bois de bouleau de 200mm d'épaisseur et une plaque de polyéthylène rouge de 50mm d'épaisseur

Spécialement conçu pour la découpe des aliments offrant résistance et fiabilité

Ce modèle intègre également un système d'élévation qui permet de réguler la hauteur de la surface de travail.

Pourquoi avons-nous conçu un billot réglable en hauteur? Nous avons pris en compte les suivants facteurs : ergonomie, réduction des maladies professionnelles et des accidents du travail.

Avec cet exemplaire, votre personnel, quelle que soit sa taille, peut adapter le lieu de travail à ces besoins particuliers, réalisant son travail quotidien de forme plus confortable et sûre, évitant les mauvaises positions et en outre mesure les possibles accidents ou blessures.

Ce système s'adapte parfaitement aux sols avec pente ou irrégularité, le plan de travail étant toujours horizontal.

Le réglage possible est de 200mm vers le haut ou vers le bas, la hauteur totale minimale étant de 805mm et la hauteur totale maximale étant de 1005mm.

Résistance et durabilité garanties.



Mas información en fricosmos.com

Mas información en fricosmos.com

Mas información en fricosmos.com

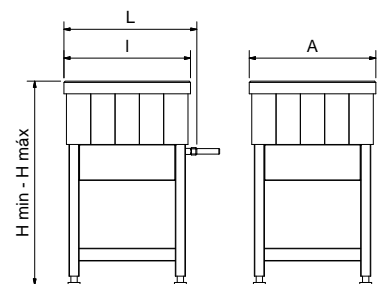

L	I	A	H min	H max	Kg	033004	€
525	500	500	805	1005	45,00	033004	1.650,00

Repuesto de mazas

Spare wooden blocks
Billots de rechange

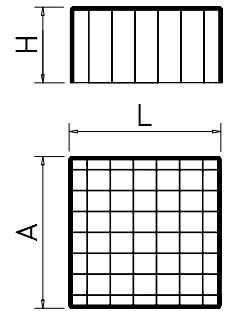
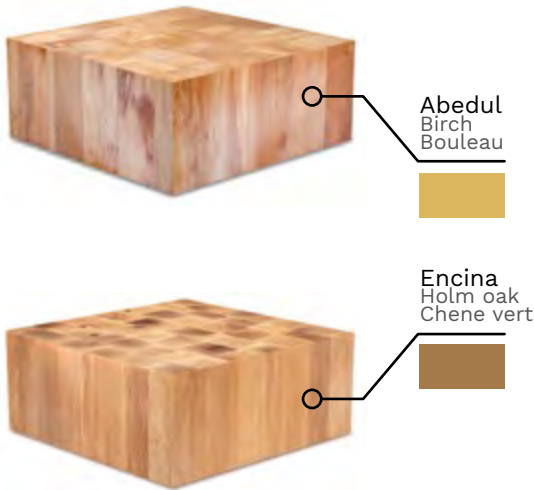

			Madera de abedul Birch wood Bois bouleau			Madera de encina Holm oak wood Bois de chene vert		
L	A	H	Kg	Barcode	€	Kg	Barcode	€
400	400	250	30	433002	240,00	40	433202	389,00
450	450	250	38	433004	259,00	50	433204	480,00
500	500	250	47	433006	321,00	62	433206	565,00
600	400	250	45	433008	306,00	60	433208	565,00
700	500	250	66	433010	438,00	87	433210	786,00
1.000	500	250	94	433012	680,00	125	433212	1.117,00

Repuesto de mazas para acoplar fibra superpuesta

Spare wooden block to attach fibre on top
Billots en bois de rechange pour accoupler fibre superposée

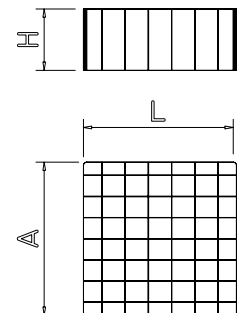

Características:

Estos repuestos de maza están preparados para llevar acoplada en su parte superior una fibra de polietileno.

Characteristics:

These spare wooden blocks are intended only to fix a polyethylene fibre on top.

Caractéristiques:







Ces blocs de rechange été désinnés seulement pour tenir superpose dans la part supérieure une fiber de polyéthylène.

			Madera de abedul Birch wood Bois bouleau		
L	A	H	Kg	Barcode	€
380	380	200	22	433014	174,00
430	430	200	28	433016	194,00
480	480	200	34	433018	234,00
580	380	200	33	433020	234,00
680	480	200	49	433022	331,00
980	480	200	71	433024	453,00

Repuestos y accesorios para tajos

Spare parts for chopping blocks

Pièces de rechange pour billots de découpe

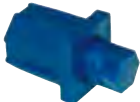
		Descripción Description Description				
						Gr
						€
	Portacuchillos para adosar con envolverte Mounted knife holder with wrapping Porte-couteaux pour adosser avec enveloppant	375	040602			86,00
	Portacuchillos para adosar en varilla Rod mounted knife holders Porte-couteaux pour adosser sur tringle	270	040802			43,00
		300	040804			46,00
		330	040806			48,00
	Portacuchillos para adosar en chapa Plated knife holders for mounting Porte-couteaux plaqué pour adosser	600	041002			24,00
		730	041004			28,00
	Acoplar portacuchillos Assembly knife holder Assembler porte-couteaux					28,00
	Tolva evacuación de desperdicios para adosar a tajos de troceo Waste receptacle for scraps to fix to chopping blocks Trémie d'évacuation des déchets pour adosser à billots	2.300	082402			66,00
	Jamonero para adosar a tajo con madera Ham holder to fix to wooden chopping block Porte-jambon pour adosser à un billot en bois	2.770	041820			167,00
	Taco regulable Adjustable blocks Taquets réglables	45	409851			1,50

Fibras estándar
Standard cutting boards
Plaques standard



Consulten si desean fibras en otros colores.
Please ask if you would like fibres in other colours.
Consultez-nous si vous voulez plaques en d'autres couleurs.

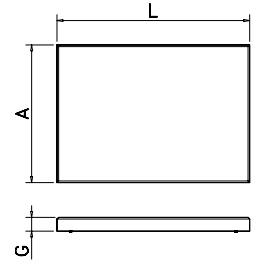

		Espesor Thick Grosseur		G = 20 mm		G = 30 mm		G = 50 mm		G = 70 mm		G = 100 mm		
L	A			€			€			€			€	
300	200		431214	15,00		431252	20,00							
			431314			431352								
			431404			431410								
			431604			431610								
			431804			431810								
			431904			431910								
400	300		431218	26,00		431256	37,00							
			431318			431356								
			431406			431412								
			431606			431612								
			431806			431812								
			431906			431912								
400	400					431261	46,00		431276	77,00				
						431357			431364			431420		
						431662			431820					
						431282			431368		97,00			
500	300		431220	32,00		431258	46,00							
			431320			431358								
			431408			431414								
			431608			431614								
			431808			431814								
			431908			431914								
500	330		431228	35,00		431260	50,00							
			431328			431360								
500	400		431230	39,00		431262	58,00		431278	96,00				
			431330			431361								
500	500								431284	179,00		431290	255,00	
									431370			431388		
										431424	109,00			
										431666			431658	179,00
600	400		431232	49,00		431264	72,00		431280	118,00				
			431332			431362			431366					
600	500		431236	57,00		431270	86,00							
			431336											
700	500								431286	169,00			431292	349,00
									431372			431374		
1.000	400					431266	115,00							
										431288	239,00			
1.000	500								431374					

Fibras GN
GN polyethylene boards
Plaques GN

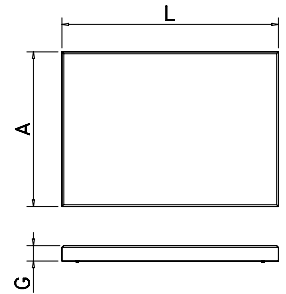

Modelo Model Model	G = 20 mm	L	A	Kg	€
					434604
					434612
1/1	530	325	3,45		434622 33,00
					434632
					434642
					434680
1/2	325	265	1,72		434652 17,00
					434658
					434664
					434670
					434676
					434684
					434654
					434660
1/3	325	176	1,14		434666 11,00
					434672
					434678
					434686
2/3	354	325	2,30		434650 22,00
					434656
					434662
					434668
					434674
					434682

Tabla de corte alta precisión
High precision cutting board
Plaque de coupe de haute précision



No adecuada para troceo y cortes profundos.
Not suitable for chopping and deep cuts.
Non appropriée pour la découpe et coupes profondes.

Características:

Diseñadas para los mejores Chefs quienes exigen alta calidad y utilizan cuchillos de alta gama.
Su suave superficie cuida el filo del cuchillo prolongando su vida.
Superficie antideslizante permitiendo cortes más delicados y precisos.
Varios colores. Certificados NSF, para evitar la contaminación cruzada.

Characteristics:

Intended for the finest Chefs, that use a high range of professional knives and demand the maximum cutting requirements.
Smooth surface for the preservation of the edge of the knife to extend its life and effectiveness.
Non-slip surface for and a smooth cutting with the highest accuracy.
Several colors. NSF certificated to avoid cross-contamination.

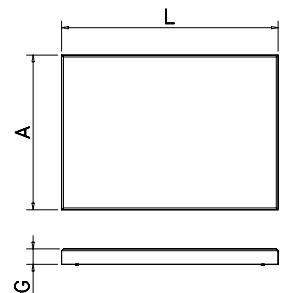

Caractéristiques:
Plaque de coupe haute précision
Conçues pour les meilleurs Chefs, avec grande exigence dans la coupe de haute qualité et l'usage de couteaux hauts de gamme.
Sa surface douce conserve le fil du couteau en prolongeant son efficacité.
Surface antidérapante permettant des coupes plus délicates et précises.
Plusieurs couleurs. Certificats NSF pour éviter la contamination croisée.

L	A	G	Gr	€
500	250	8	900	434494 40,00
340	230	8	600	434496 30,00
500	250	8	900	434498 40,00

Fibra redonda de corte de polietileno de alta densidad P500

Round high density P500 polyethylene cutting board

Plaque de découpe ronde de polyéthylène de haute densité P500

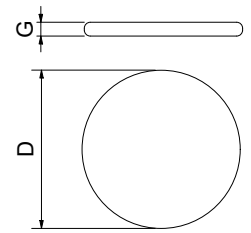

D	G		Kg	Barcode	€
500	50		9,8	431275 431392	159,00

Fibras a medida

Bespoke cutting boards
Plaques sur mesure



Como calcular el precio de sus fibras a medida

How to calculate the price of your bespoke cutting boards
Comment calculer le prix de vos plaques sur mesure ?



P.ej.: Una fibra roja de 0,525 m x 0,365 m en 30 mm de espesor, haríamos la siguiente operación:
 $0,525 \times 0,365 = 0,1916 \text{ m}^2$

Por lo que su precio de venta al público se obtendría de la siguiente manera:
 $0,1916 \text{ m}^2 \times 285,00 \text{ euros/metro cuadrado} = 54,61 \text{ Euros.}$



For example: for a red fibre of 0.525 mts. x 0.365 mts. and 30 mm. thick we would proceed in the following way

So that the public price should be obtained as follows:
 $0.1916 \text{ m}^2 \times 285.00 \text{ €/m}^2 = 54,61\text{€.}$

Par exemple: pour une fibre rouge de 0.525 mts. x 0.365 mts. et 30 mm. d'épaisseur on procède de la façon suivante.

Tellement que le prix de vente au public serait obtenu comme suivre:
 $0.1916 \text{ m}^2 \times 285.00 \text{ €/m}^2 = 54,61\text{€.}$



Se pueden instalar tacos antideslizantes en las fibras sin cargo alguno. Indíqueno a la hora de hacer el pedido.

Antisliding pegs can be installed without additional cost. Please, let us know when placing your order.

On peut installer chevilles antiglissantes dans les plaques sans coût additionnel. Indiquez-le dans la commande.

Grueso Thick Epaisseur mm.	€ m2	Barcode					
20	189,00	432006	432106	432406	432606	432806	432706
30	285,00	432010	432110	432410	432610	432810	432710
50	475,00	432014	432114	432414	432614	432814	432714

Repuesto de fibras para mesas

Spare polyethylene boards for tables
Plaques de rechange pour tables

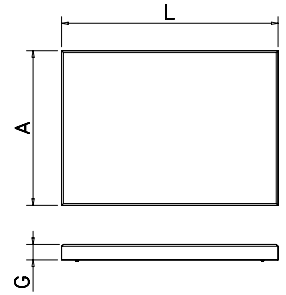

L	A	G	Kg	Barcode	€
1.000	500	20	10,00	431223 431323	96,00
1.500	500	20	15,00	431225 431325	143,00
2.000	500	20	20,00	431227 431327	190,00
1.000	600	20	12,00	431229 431329	114,00
1.500	600	20	18,10	431231 431331	171,00
2.000	600	20	24,00	431233 431333	228,00
1.000	700	20	14,00	431235 431335	133,00
1.500	700	20	21,00	431237 431337	200,00
2.000	700	20	28,00	431239 431339	266,00

L	A	G	Kg	Barcode	€
1.000	480	20	9,60	432030 432130	92,00
1.500	480	20	14,40	432032 432132	137,00
2.000	480	20	19,20	432034 432134	183,00
1.000	580	20	11,60	432036 432136	111,00
1.500	580	20	17,40	432038 432138	166,00
2.000	580	20	23,20	432040 432140	222,00
1.000	680	20	13,60	432042 432142	130,00
1.500	680	20	20,40	432044 432144	194,00
2.000	680	20	27,20	432046 432146	259,00

L	A	G	Kg	Barcode	€
540	480	20	5,20	431234 431654 431334	74,00*
545	500	20	5,00	431217 431653 431317	76,00*
700	500	20	7,00	431238 431656 431338	90,00*
1.000	500	30	10,00	431650	145,00*

● Con agujero de 150 mm de diámetro.
With 150 mm diameter hole.
Avec trou de 150 mm.

L	A	G	Kg	Barcode	€
760	500	20	7,60	431215 431655 431315	76,00
500	400	20	4,00	431652	39,00
500	400	40	8,00	431274	58,00
1.000	300	20	6,00	431222 431322	57,00
1.500	300	20	9,00	431224 431324	86,00
2.000	300	20	12,00	431226 431326	114,00
1.500	400	20	12,00	431293 431376	115,00
2.000	400	20	16,00	431294 431378	152,00
2.500	300	20	20,00	431295 431380	145,00
3.000	300	20	24,00	431296 431382	257,00

Fibras por planchas
Polyethylene sheets
Fibras par plaque

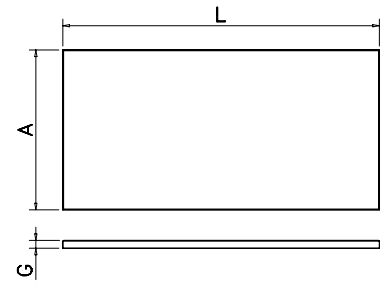
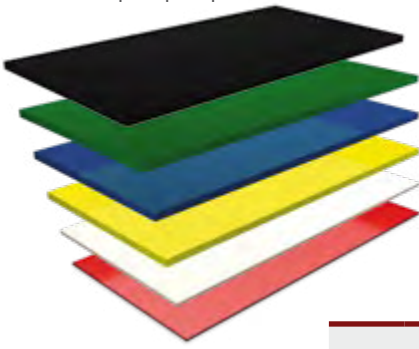

L	A	G	€/ud.	Kg	Barcode 1	Barcode 2	Barcode 3	Barcode 4	Barcode 5	Barcode 6
2.020	1.020	20	391,00	41,2	431028	431128	433406	433606	433806	433706
2.020	1.020	30	587,00	61,9	431032	431132	433410	433610	433810	433710
2.020	1.020	40	782,00	82,4	431034	431134				
2.020	1.020	50	987,00	103,0	431036	431136	433414	433614	433814	433714

Tajo-expositor para mostrador de pescadería

Polyethylene cutting board-display for fish counter
Plaque de découpe-exposant en polyéthylène pour étal à poisson

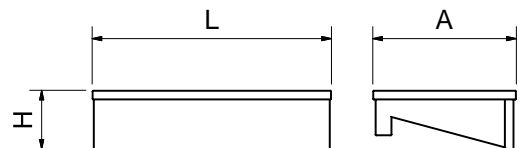
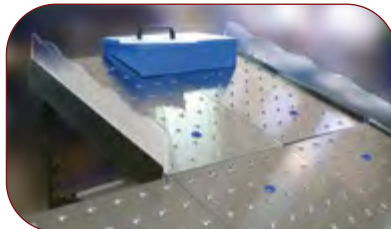

L	A	H	Kg	Barcode	€
500	300	125	4,70	074460	190,00

Tope para fibras

Brackets for polyethylene boards
Butée pour plaques

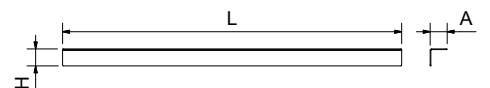

Detalle de fijación a fibra.
Fibre fixing detail.
Détail de fixation.

L	A	H	Gr	Barcode	€
395	20	20	102	035002	5,00

Cepillo rascador de fibras

Plane for fibres
Rabot pour plaques



434452



21,00



2



Juego de cuchillas de repuesto para cepillo rascador.
Spare scraper blades set for plane
Jeu de lames de réchange pour rabot à racloir

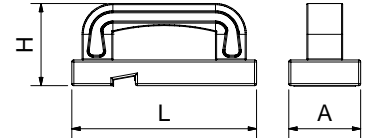
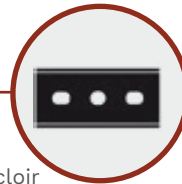

L	A	H	Gr	Barcode	€
180	70	80	500	434450	77,00

Cepillo cerdas inox

Brush with stainless steel bristles
Brosse d'acier inoxydable

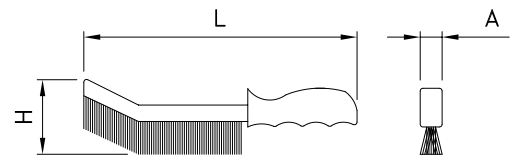

L	A	H	Gr	Barcode	€
240	10	50	400	434474	15,00

Escurridor para fibras de corte

Chopping board rack
Egouttoir pour planches à découper

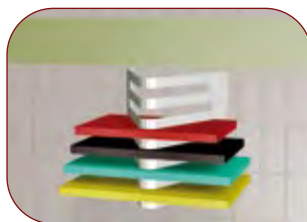

Ejemplos de utilización de forma mural o sobremesa.
Examples of using a wall-mounted or standing.
Exemples d'utilisation sur table ou accroché au mur.

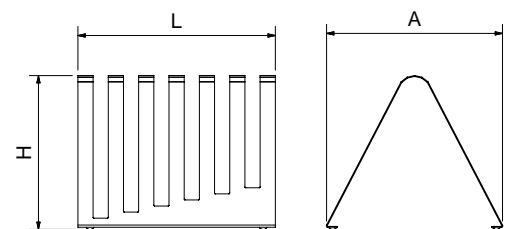

L	A	H	Kg	Barcode	€
325	290	250	1,55	035004	65,00

Estropajo para tablas de corte

Cutting board scraper

Éponges pour plaque de coupe



Características:

Tecnología patentada de excepcional capacidad de raspado. Borra las manchas duras, el amarilleo por el uso, marcas y mohos de la superficie de las tablas de corte. Además permite suavizar la superficie después del raspado.

Este producto está diseñado para un mantenimiento diario de sus tablas de corte, de suma importancia para mantenerlas en óptimas condiciones de higiene.

Characteristics:

Patented technology with exceptional scraping capability. It is specially recommended to remove the most stubborn dirt, the yellowing by use or any mark on the surface of cutting boards.

This product is intended for daily maintenance of your cutting boards, which is essential to keep them in optimal hygienic conditions.

Caractéristiques:

Une technologie patentée de capacité exceptionnelle de grattage. Elle efface les taches dures, le jaunissement par l'usage, les marques et les moisissures de la surface des plaques de coupe. De plus elle) permet d'adoucir la surface après le grattage.

Ce produit est conçu pour une maintenance quotidienne de vos plaques de coupe, d'importance suprême pour les maintenir dans des conditions parfaites d'hygiène.

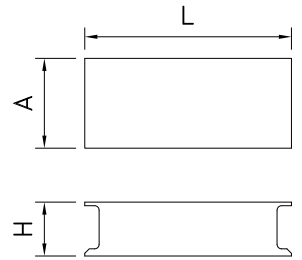
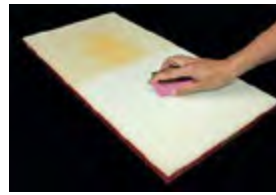

L	A	H	Gr	Barcode	€
115	50	30	18	434006	9,00

Calzo elevador para fibra

Levelling blocks for polyethylene boards

Cale pour plaque de découpe

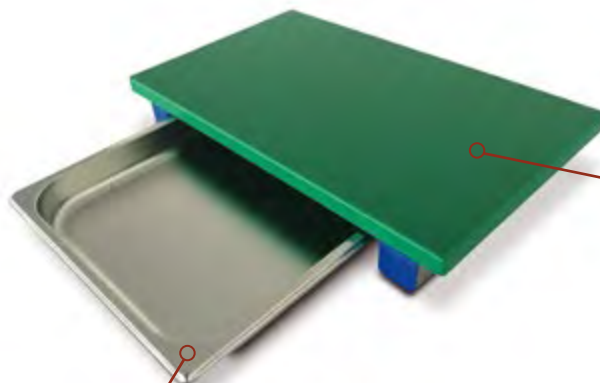
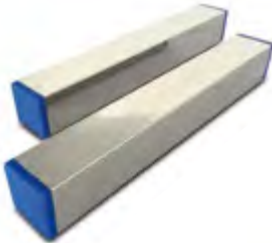

431806 26,00 75

Fibras estándar 400x300x20
Standard cutting board 400x300x20
Plaques standard 400x300x20



435

Cubetas Gastronorm lisas.
Non-perforated Gastronorm
containers.
Bacs Gastronorm lisses.

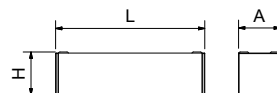

L	A	H	Gr	Kg	Barcode	€
285	40	45	2	0,75	035010	25,00
285	80	85	2	2,90	035012	50,00



El precio es por pareja.
The pair is included in the price.
Le paire est inclus dans de prix.

Útil de centrado para corte de fruta

Fruit preparation centering tool

Accessoire de préparation pour centrage de fruit



Características:

Construido en fibra de polietileno, su diseño permite cortar con seguridad sandías, melones, piñas, etc.

Characteristics:

Made from polyethylene. Designed for cutting safely melons, pineapples, watermelons, etc.

Caractéristiques:

Fabriqu  en poly thyl ne. Con u pour couper en toute s curit  les melons, ananas, p t ques, etc.

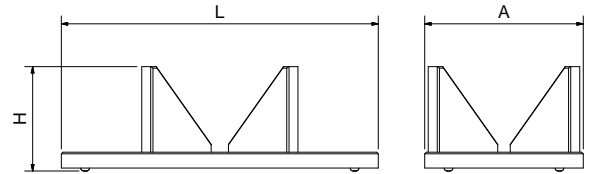

L	A	H	Kg	Barcode	€
400	200	132	2,10	042202	125,00

Fibra de colores intercambiables

Fibre with interchangeable colour set

Plaque de couleur interchangeable

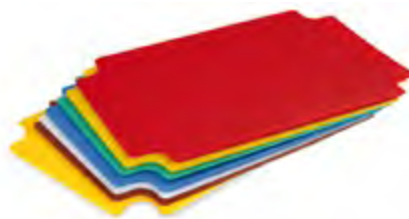

Colores incluidos: Marr n, blanco, azul, verde, amarillo y rojo.

Colors included: Brown, white, blue, green, yellow and red.

Couleurs inclus: Marron, blanc, bleu, vert, jaune et rouge.

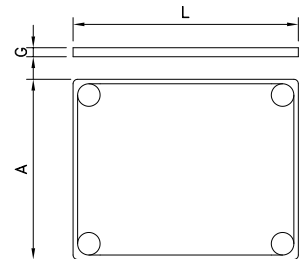

L	A	G	Kg	Barcode	€
500	400	20	7,00	434470	67,00

Pack de 6 colores de repuesto

Spare pack of 6 colours

Set de 6 couleurs de rechange

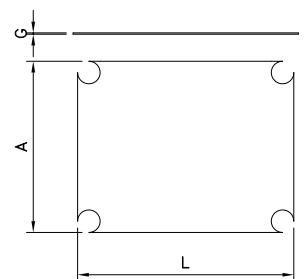
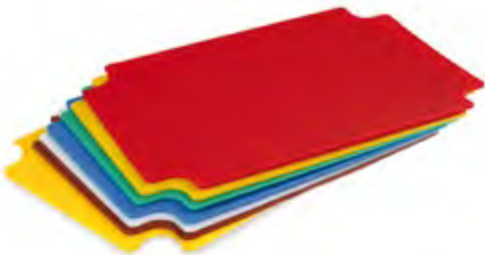

L	A	G	Kg	Barcode	€
500	400	3	3,00	434468	37,00

Tabla de corte/pala de fibra
Cutting board/fiber shovel
Plaque à découper/pelle en fibre



Fabricada en polietileno.
Fácil limpieza (lavavajillas).

Made of polyethylene.
Easy to clean (dishwasher).

Fabriquée en polyéthylène.
Nettoyage facile (lave-vaisselle).

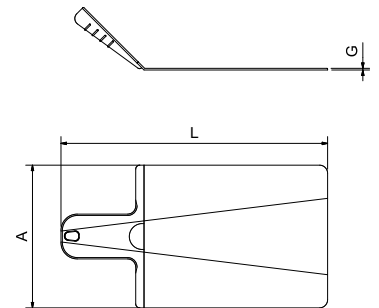

L	A	G		Kg		€
380	210	15		0,90	434480	23,50
480	270	15		1,50	434482	23,50

Fibra para corte de pan
Bread cutting board
Planche à découper le pain

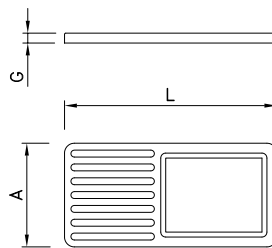

L	A	G		Kg		€
---	---	---	--	----	--	---

430 210 20 1,80 434446 **47,00**

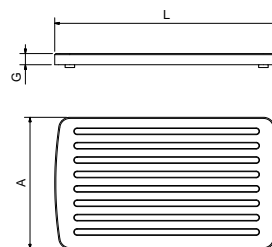

400 240 20 1,60 434444 **27,00**

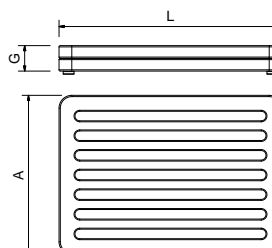

350 250 40 3,00 434448 **62,00**

430 330 40 5,00 434449 **80,00**

Rodillo
Rolling pin
Rouleau



L	D	Kg	Barcode	€
600	60	1,2	434440	52,00

Mazo de picar
Mincing hammer
Marteau à viande

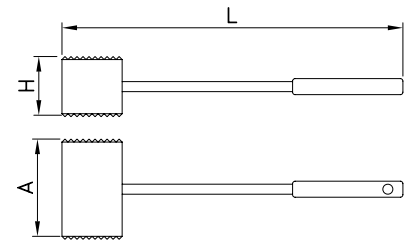

L	A	H	Kg	Barcode	€
340	100	60	1,20	434454	54,00

Remo
Polyethylene mixing paddle
Spatule à mélanger en polyéthylène

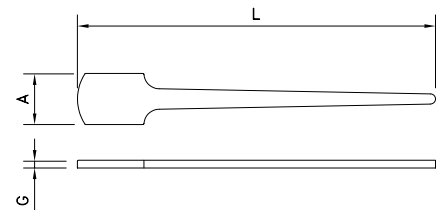

L	A	G	Gr	Barcode	€
450	105	15	200	434402	18,00
700	105	20	400	434404	30,00
995	100	25	600	434406	54,00

Pala de acero inoxidable y polietileno
Stainless steel and polyethylene mixing paddle
Spatule à mélanger en acier inoxydable et polyéthylène

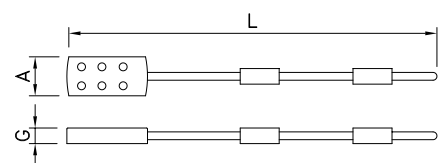

L	A	G	Kg	Barcode	€
1.000	100	25	1,00	434456	79,00
1.348	110	28	1,32	434458	92,00

Útil para picadora

Tool for mincer
Outil pour hachoir

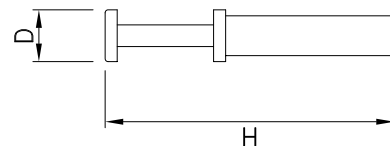

D	H	Gr	Barcode	€
43	240	350	434462	39,00
55	310	600	434464	44,00



Mazo para chino

Tool for strainer
Outil pour chinois étamine

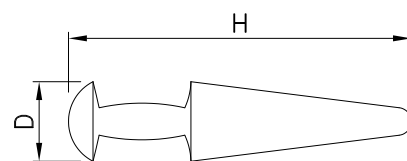

D	H	Gr	Barcode	€
65	280	400	434460	55,00

Mortero

Mortar
Mortier

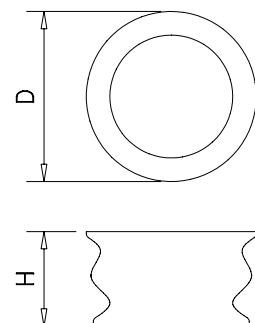

D	H	Kg	Barcode	€
180	100	1,4	434442	140,00

Conjunto aros de emplatar

Ring mold set
Set de moules

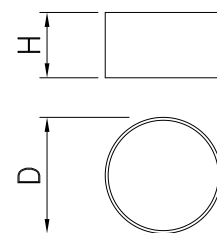

D	H	Gr	Barcode	€
60	45	150	434472	13,00
80	45	150		

Triángulo

Triangle
Triangle

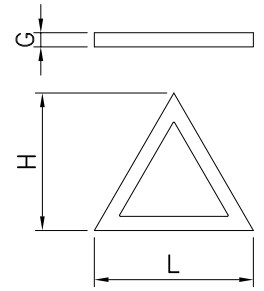

L	H	G	Gr	Barcode	€
435	380	20	500	434476	49,00

Enrollador de maki higiénico

Sushi rolling mat, hygienic
Enrouleur de maki hygiénique



Los mejores enrolladores super-higiénicos de makis con gran capacidad antiadherente del arroz. Un enrollador revolucionario que no hace uso de las tradicionales varitas de bambú ni del algodón para su cosido, sino de plásticos y monofilamentos avanzados. No sólo son higiénicos, sino también fáciles de rodar como un enrollador tradicional.

Principales ventajas:

- Apto para lavavajillas.
- No genera astillas o moho negro, como los bambúes convencionales.
- Los monofilamentos del cosido repelen la contaminación.
- Menor probabilidad de que el arroz se adhiera a sus superficies en relieve.
- Rápido secado para poder ser utilizado después del lavado.
- Tan fácil de rodar como los enrolladores convencionales de bambú.

Les meilleurs enrouleurs super-hygiéniques de makis avec une grande capacité antiadhésive du riz. Un enrouleur révolutionnaire qui n'utilise pas les traditionnelles baguettes de bambou ni du coton pour sa couture, sinon des plastiques et des monofilaments avancés. Non seulement ils sont hygiéniques, mais aussi faciles de rouler comme un enrouleur traditionnel.

Avantages principaux :

- Aussi facile de rouler que les conventionnels en bambou.
- Ne génère pas d'éclats ou de moisissure noire, comme les bambous conventionnels.
- Les monofilaments de couture repoussent la contamination.
- Une probabilité moindre que le riz s'adhère à ses surfaces en relief.
- Apte pour le lave-vaisselles.
- Sèche rapidement pour pouvoir être utilisé après le lavage.

The best makisu ever that are super hygienic and less likely to stick to rice.

A revolutionary makisu that makes use of neither the traditional bamboo nor cotton strings but advanced plastic and monofilaments. They are not only hygienic but also easy to roll as a makisu.

Its main advantages:

- Dishwasher safe, bleach safe.
- Does not generate splinters or black mold, like the conventional bamboo ones always does.
- Monofilaments that deter contamination are used for the binding strings.
- Rice less likely to stick to its embossed surfaces.
- Easy to dry so that can be used soon after washing.
- As easy to roll as conventional bamboo ones.

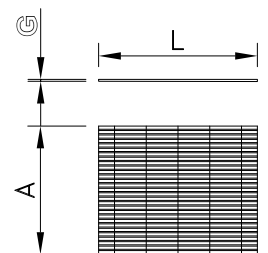

L	A	G	Gr	Barcode	€
250	165	3	110	434486	30,00
250	240	3	160	434488	35,00
250	305	3	200	434490	45,00



CUCHILLERIA

PROFESSIONAL KNIVES
COUTELLERIE PROFESSIONNELLE

NOVEDADES

NEWS
NOUVEAUTÉS



94



95



97



97



97



98



98



98



104



108



114



114



115



116



116



116



116



116



121



123



123



123



130



134



CUCHILLERIA

PROFESSIONAL KNIVES

COUPELLERIE PROFESSIONNELLE

NOVEDADES

NEWS
NOUVEAUTÉS

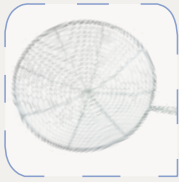

140

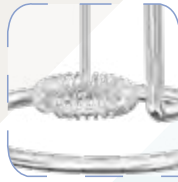

141



144



146



146



148



149



150



150



152

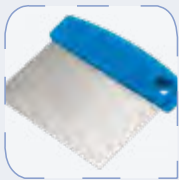

154

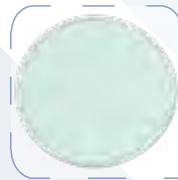

154



155



157



160



164



166

LEYENDA SYMBOLS / SYMBOLES

STD

Estándar
Standard
Standart



Forjado
Forged
Forgé



Reforzado
Reinforced
Renforcé



Mango remachado
Riveted handle
Manche riveté



Mango inyectado
Injected handle
Manche injecté





Cuchillería profesional para Carniceros

Professional cutlery for Butchers
Coutellerie professionnelle pour Bouchers

Fileteros
Filet knives
Couperet-steak

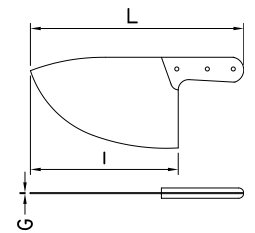

	L	I	H	G	Tipo Type	Gr	Barcode	€
	365	250	160	1,4	STD ↑	545	442202	38,50
	410	290	185	1,4	STD ↑	610	442206	68,50
	365	240	115	1,3	STD ↑	420	442208	51,00
	370	260	135	1,3	STD ↑	430	442212	55,00
	400	270	140	1,3	STD ↑	440	442214	60,00
	220	120	1,5	STD ↑	420	442200	33,50	
	250	140	1,5	STD ↑	580	442201	36,00	

Chuleteros
Chop knives
Couperet cotelettes

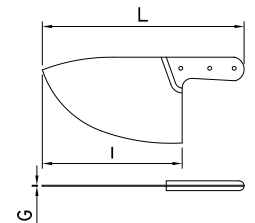

	L	I	H	G	Tipo Type	Gr	Barcode	€
	365	240	115	2,5	STD ↑	610	442408	56,00
	365	250	130	2,5	STD ↑	705	442412	62,00
	370	260	140	2,5	STD ↑	720	442414	65,00

Esquinar
 Cornering knife
 Couteau pour coins

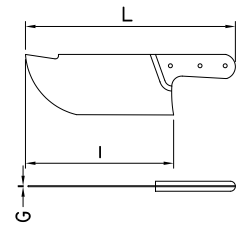

	L	I	H	G	Tipo Type	Gr	Barcode	€
	365	235	110	3,2	STD ↑	845	442602	66,00
	365	255	115	3,0	STD ↑	890	442604	78,00
	365	275	135	3,0	STD ↑	990	442608	89,00
	340	210	110	3,0	STD ↑	745	442802	56,00
	345	220	120	3,5	STD ↑	795	442804	62,00
	360	230	125	3,5	STD ↑	885	442806	69,00
	380	250	140	3,5	STD ↑	1.035	442808	70,50
	400	270	150	3,5	STD ↑	1.110	442810	77,00
	405	280	160	3,5	STD ↑	1.270	442812	91,00

Cuchillo todos usos
 Multipurpose Knife
 Couteau tous usages

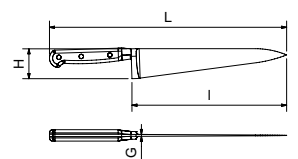

							Uso general General use Usage generale	Aves Chickens Volailles	Pescados Fish Poissons	Frutas y verduras Fruits & Vegetables Fruits et légumes	Carnes Meat Viandes
L	I	H	G	Tipo Type	Gr	€	Barcode	Barcode	Barcode	Barcode	
310	175	35	2,6	STD ↑	135	12,50	444002	444074	444020	444056	444038
335	205	60	2,6		160	17,00	444004	444076	444022	444058	444040
355	220	40	2,6		190	19,50	444006	444078	444024	444060	444042
380	250	50	2,6		210	20,50	444008	444080	444026	444062	444044
430	305	50	2,6		275	24,00	444010	444082	444028	444064	444046
485	350	55	2,6		330	31,00	444012	444084	444030	444066	444048

Cuchilla de golpe
Blow knife
Couperet à frapper

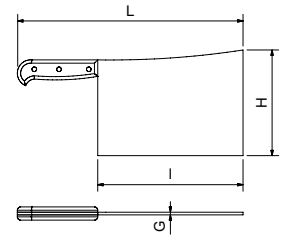

L	I	H	G	Tipo Type	Gr	Barcode	€
360	230	165	3,37	†	1.175	442002	93,00
380	255	185	3,37	†	1.350	442004	114,00
390	270	215	4,00	†	1.795	442006	115,00



305	195	160	4,5	STD	1.200	442010	140,00
330	220	170	4,5	STD	1.485	442012	150,00
350	240	170	4,5	STD	1.665	442014	189,00
360	245	190	4,5	STD	1.850	442016	192,00



330	210	180	3,5	†	1.045	442018	78,00
340	215	190	3,5	†	1.180	442020	81,00
345	220	200	3,5	†	1.250	442022	88,00
355	225	210	3,5	†	1.355	442024	94,00
370	240	220	4,0	†	1.570	442026	104,00
380	250	230	3,5	†	1.685	442028	94,00



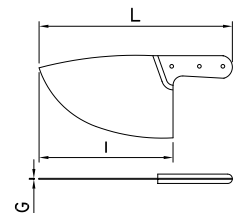

Deshuesar Carne
Boning meat knife
Désosseur

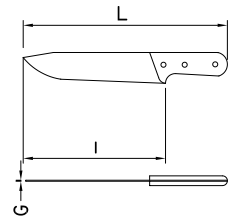

L	I	H	G	Tipo Type	Gr	Barcode	€
310	195	115	2,50	†	580	443404	50,00
320	200	120	2,70	†	635	443406	55,00
330	215	130	2,70	†	675	443408	54,00
355	270	125	2,70	†	715	443410	58,00

Desollar
Skinning knife
Ecorcheur



	L	I	H	G	Tipo Type	Gr	Barcode	€
	285	210	90	1,5	STD ↑	250	443604	23,00
	305	220	105	1,5	STD ↑	260	443606	24,50
	280	170	55	2	STD ↑	175	443802	18,50
	320	200	75	2	STD ↑	260	443806	25,50
	340	210	75	3	STD ↑	255	443808	27,00
	355	220	35	2,24	STD ↑	95	443002	18,50
	275	150	30	2,80	STD ↑	115	443004	19,00
	310	175	35	2,50	STD ↑	135	443006	20,00
	290	165	65	2	STD ↑	175	443810	16,50

Pelar patas
Leg peeling knife
Couperet d'office

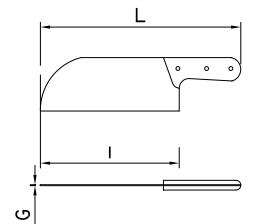

L	I	H	G	Tipo Type	Gr	Barcode	€
210	125	55	1,7	STD ↑	145	444202	13,00

Pollero
Poultry knife
Couteau à poulets

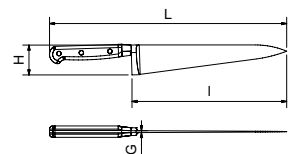

L	I	H	G	Tipo Type	Gr	Barcode	€
440	315	90	3,3	↑	745	447002	56,50
465	340	90	3,3	↑	805	447004	65,00

Puntilla
Dagger
Poignard

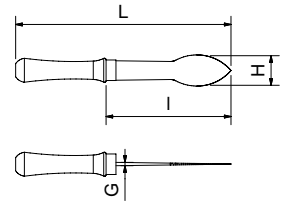

L	I	H	G	Gr	Barcode	€
260	140	33	4,5	185	444402	39,00

Serrucho acero inoxidable
Stainless steel saw
Scie en acier inoxydable

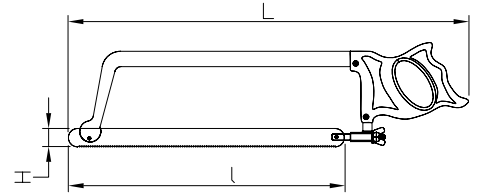

L	I	H	Gr	Barcode	€
565	400	165-20	835	447602	63,00
625	450	165-20	900	447604	65,00
725	550	165-20	1.050	447612	70,00

Repuestos para serruchos
Spare parts for saws
Pièces de rechange pour scie à main



			Gr	Barcode	€
	420	35	447606	12,50	
Hoja de repuesto inox. Spare inox blade Lame inox de rechange	470	40	447608	13,00	
	570	50	447610	13,50	
Mango de repuesto para serrucho Spare handle for saw Manche de rechange pour scie à main	210	200	447630	16,00	
Tensor inox de repuesto Spare inox strut Tendeur inox de rechange	50	25	447620	16,00	

Aplasta hamburguesas circular
Rounded burger press
Press à hamburger ronde

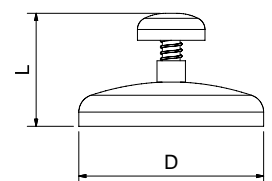

L	D	Gr	Barcode	€
70	104	250	041880	75,00

Aplasta hamburguesas higiénico doble
 Hygienic hamburger press, double
 Presse hamburger hygiénique double



Novedad
 New
 arrival

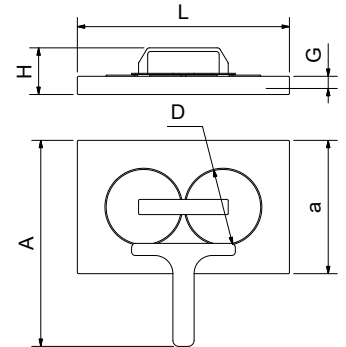

L	A	H	a	D	G	Kg	Barcode	€
325	315	80	195	100	20	2,0	041882	121,00
350	340	80	220	128	20	2,5	041884	146,00

Aplasta hamburguesas de molde ovalado
 Oval mold burger press
 Presse à hamburger moule ovale



Tamaño de la hamburguesa: 110x80 mm.
 Burger size: 110x80 mm.
 Taille burger: 110x80 mm.

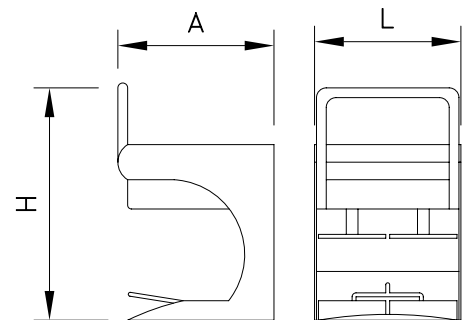

L	A	H	Kg	Barcode	€
●●	210	230	260	3,40	441850 332,00
●●●●	410	230	260	14,00	441852 370,00

Aplasta hamburguesas de molde redondo

Round mold burger press
Press à hamburger moule rond



∅
130

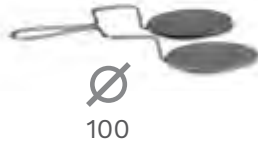

∅
100



∅
65

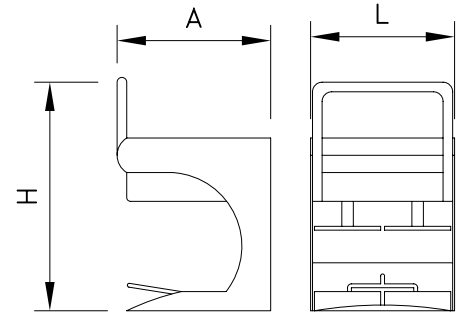

	L	A	H	∅	Kg	Barcode	€
● ●	210	250	260	65	2,00	441846	343,00
● ● ● ●	410	250	260	65	3,00	441848	400,00
● ●	245	250	145	100	2,90	441854	314,00
● ●	410	250	260	130	6,00	441856	393,00

Repuestos para aplasta hamburguesas

Spare parts for burger presses
Pièces de rechange pour press à hamburger



	Gr	Barcode	€
--	----	---------	---

Muelle elevación de palanca
Spare lifting spring for lever
Lame inox de rechange

9,00 441860 **15,00**

Pareja de muelles
Springs
Ressort gauches

26,00 441862 **29,00**

Protector para picadora de carne

Meat grinder protection
Protecteur de hachoir à viande

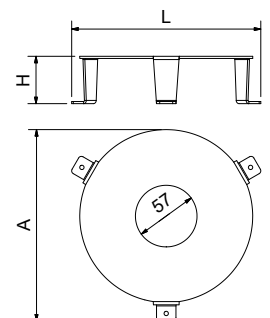

Novedad
NEW
material

L	A	H	Gr	Barcode	€
175	177	44	340	042210	26,00



Cuchillería profesional para charcuteros

Professional cutlery for pork butchers
Coutellerie professionnelle pour charcutiers

Fiambre
Sausage knife
Charcuterie

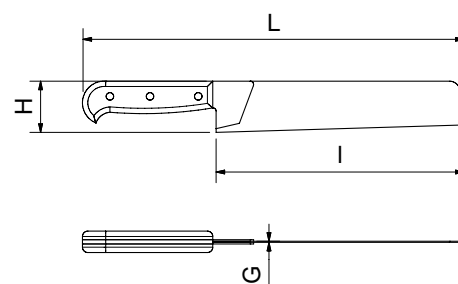

L	I	H	G	Tipo Type	Gr	Barcode	€
375	250	50	2,0	STD ↑	310	444806	22,50
425	300	60	2,5	STD ↑	405	444808	33,50
450	330	65	2,5	STD ↑	410	444810	32,00
475	350	65	2,5	STD ↑	475	444812	41,00

Fiambre dos mangos
Double handle sausage knife
Charcuterie deux manches

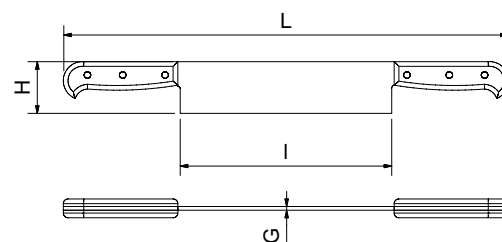

L	I	H	G	Tipo Type	Gr	Barcode	€
500	260	50	2,6	STD ↑	505	445002	31,50
615	355	57	2,8	STD ↑	645	445006	46,00

Queso
 Cheese knife
 Couteau à fromage

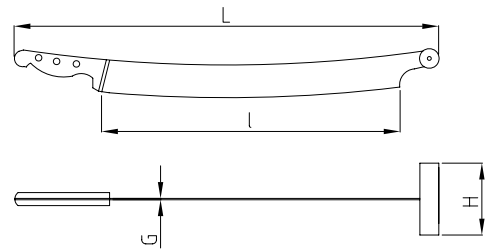

L	I	H	G	Tipo Type	Gr	Barcode	€
670	445	110	2,6	STD †	535	448202	59,00

Cuchillo especial queso tierno
 Soft cheese knife
 Couteau spécial fromage à pâte molle

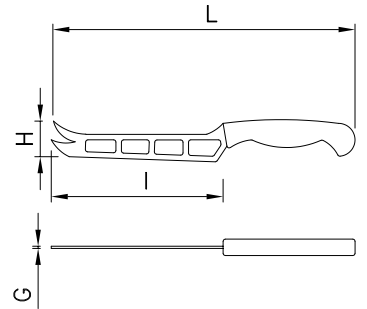

L	I	H	G	Tipo Type	Gr	Barcode	€
260	140	35	1,6	STD †	41	448212	32,00

Cuchillo especial queso lama perforada
 Special cheese knife with perforated blade
 Couteau à fromage spécial avec lame perforée

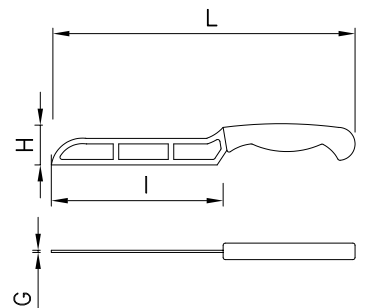

L	I	H	G	Tipo Type	Gr	Barcode	€
340	220	34	1,7	STD †	100	448214	34,00

Cuchillo especial queso Pavia
 Knife for Piave cheese
 Couteau à fromage spécial pour Pavia ou Parmesan

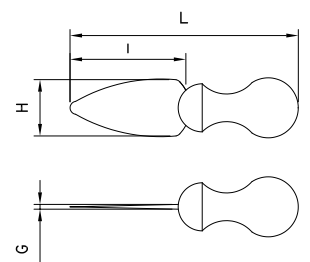

L	I	H	G	Tipo Type	Gr	Barcode	€
190	100	45	3,7	STD †	135	448204	20,50

Cuchillo especial queso Parmesano
 Knife for Parma cheese
 Couteau spécial Parmesan

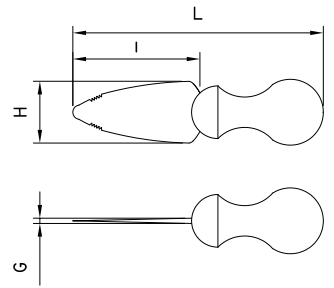

L	I	H	G	Tipo Type	Gr	Barcode	€
230	150	43	3,5	STO	145	448216	27,50

Cuchillo especial queso Feta
 Knife for Feta cheese
 Couteau à fromage spécial Feta

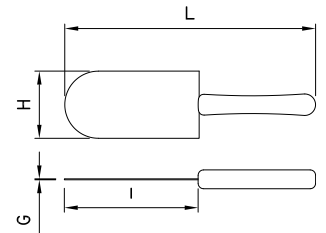

L	I	H	G	Tipo Type	Gr	Barcode	€
280	150	75	1,5	STO	170	448208	29,00

Cuchillo especial queso Emmental
 Knife for Emmental cheese
 Couteau à fromage spécial Emmental

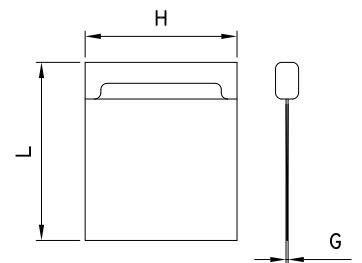

L	H	G	Tipo Type	Gr	Barcode	€
230	170	2,0	STO	515	448206	88,00

Lira para cortar queso
 Cheese slicer
 Lyre pour couper le fromage

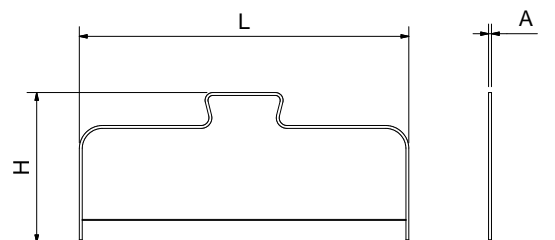

L	A	H	Gr	Barcode	€
100	5	185	106	448210	8,00

Pala pequeña inox para loncheado de embutidos
 Small stainless steel sausage slicing shovel
 Petite pelle pour trancher la charcuterie



Fabricadas completamente en acero inoxidable, esta pala para loncheado de embutidos permite embolsar y/o envasar al vacío el embutido de manera fácil e higiénica.

Mades entirely of stainless steel, this sausage slicing shovel allows you to bag and / or vacuum pack the sausage easily and hygienically.

Entièrement fabriquées en acier inoxydable, cette pelle pour trancher la charcuterie vous permet d'envelopper et / ou d'emballer sous vide la charcuterie facilement et de manière hygiénique.

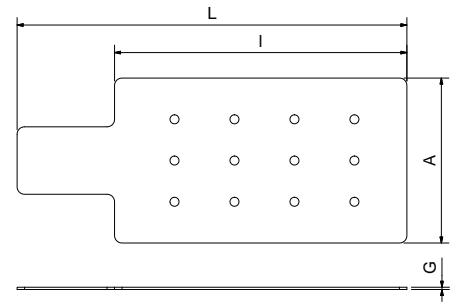

L	I	H	G	Gr	Barcode	€
260	195	110	1,5	288	041860	15,00

Pala grande inox para loncheado de embutidos
 Large stainless steel sausage slicing shovel
 Grande pelle pour trancher la charcuterie



Fabricadas completamente en acero inoxidable, esta pala para loncheado de embutidos permite embolsar y/o envasar al vacío el embutido de manera fácil e higiénica.

Mades entirely of stainless steel, this sausage slicing shovel allows you to bag and / or vacuum pack the sausage easily and hygienically.

Entièrement fabriquées en acier inoxydable, cette pelle pour trancher la charcuterie vous permet d'envelopper et / ou d'emballer sous vide la charcuterie facilement et de manière hygiénique.

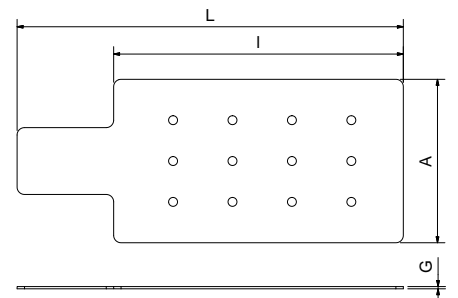
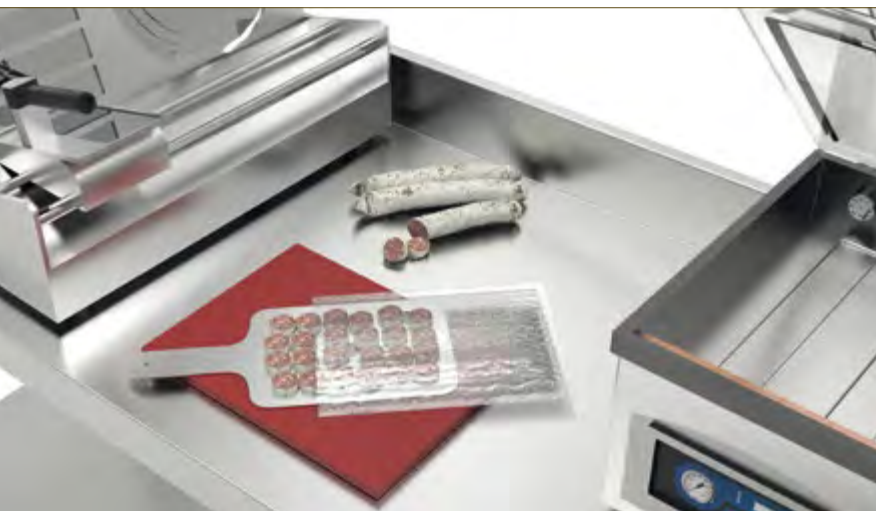

L	I	H	G	Gr	Barcode	€
320	200	150	1,5	396	041862	17,00



AD

Mundo del jamón

World of ham
Monde du jambon

Les presentamos el nuevo sistema RT de sujeción, con un solo punto de apoyo, diseñado para la presentación, corte y almacenamiento del jamón.

RT clamping system, with a single supporting point, designed for presentation, cutting and storage of ham.

Système de fixation RT, avec un seul point d'appui, conçu pour la présentation, la coupe et le stockage du jambon.



Con nuestros novedoso sistema de soporte RT podrá trasladar el jamón de la barra expositora al jamonero en un instante.

Fácil intercambio del jamón a cortar. El útil de acoplamiento RT que incorpora está diseñado para colocar instantáneamente el jamón en el jamonero.

With our innovative RT support system you can move the ham from the display bar to the ham holder instantly.

The ham is easily exchangeable. The built-in RT coupling tool is designed to instantaneously place the ham in the ham holder.

Avec notre nouveau système de support RT, vous pouvez déplacer le jambon de la barre d'exposition au support de jambon en un instant.

Facile échange de jambon à couper. L'outil de couplage RT intégré est conçu pour placer instantanément le jambon dans le porte-jambon.





Profesional, este sistema le ayudará a exponer mejor el jamón, colocándolo en la posición más adecuada en cada momento, favoreciendo la facilidad y efectividad del corte.

Professional, this system will help you to display the ham better. In addition, you will be able to slice it in the most appropriate position at each moment to slice it in an easy and effective way.

Professionnel, ce système vous aidera à mieux exposer le jambon, en le plaçant dans la position la plus appropriée à chaque moment, en favorisant la facilité et l'efficacité de la coupe.



Higiénico, al tener un solo punto de apoyo y quedar el jamón suspendido, las labores de limpieza se facilitan al máximo.

The ham is hold with one single supporting point, which results in an easy cleaning and better hygiene.

Hygiénique, n'ayant qu'un seul point d'appui et laissant le jambon suspendu, les tâches de nettoyage sont facilitées au maximum.



Con nuestros útiles de acoplamiento RT puede tener varios jamones expuestos y preparados para cortar en cualquier momento.

With our RT coupling tools you can have several hams displayed and ready to slice it at any time.

Avec nos outils de couplage RT, vous pouvez avoir plusieurs jambons exposés et prêts à couper à tout moment.

Este novedoso sistema permite:
Rotación 360° en dos dimensiones [Modelos RT-2D]
Rotación 360° en tres dimensiones [Modelo RT-3D]

This innovative system allows:
360° rotation in two dimensions [Models RT-2D]
360° rotation in three dimensions [Model RT-3D].

Ce système innovant permet:
Rotation à 360° en deux dimensions [Modèles RT-2D]
Rotation à 360° en trois dimensions [Modèle RT-3D]



Jamonero giratorio basculante RT-3D
 Tilting rotating ham holder RT-3D
 Porte-jambon giratoire basculant RT-3D



Se puede atornillar o soldar a cualquier superficie.

To be screwed or welded on any surface.

Peut se visser ou souder à n'importe quelle surface.

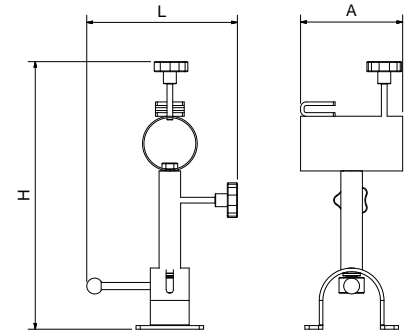

L	A	H	Kg	Barcode	€
210	140	370	1,8	041806	182,00

Jamonero giratorio RT-2D
 Rotating ham holder RT-2D
 Porte-jambon giratoire RT-2D



Se puede atornillar o soldar a cualquier superficie.

To be screwed or welded on any surface.

Peut se visser ou souder à n'importe quelle surface.

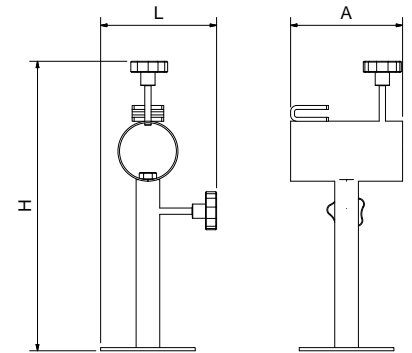

L	A	H	Kg	Barcode	€
150	140	370	1,4	041808	123,00

Jamonero giratorio mural RT-2D
 Wall-mounted rotating ham holder RT-2D
 Porte-jambon giratoire mural RT-2D

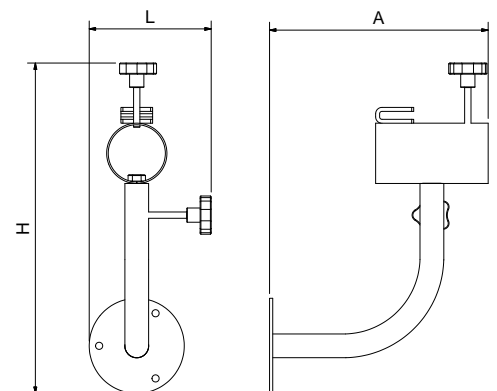

L	A	H	Kg	Barcode	€
155	275	415	1,8	041810	128,00

Soporte jamón RT
Ham holder RT
Support jambon RT

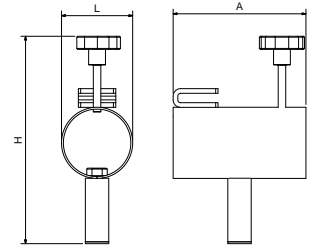

L	A	H	Gr	041812	€
75	140	220	800	041812	68,00

Útil para sujeción de jamones
Ham holder tool
Outil pour porter jambons

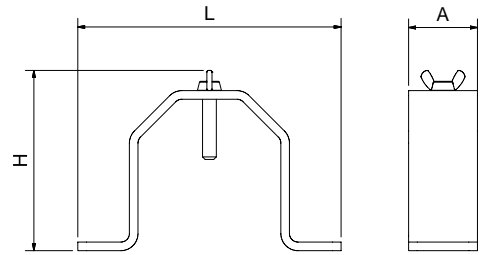

L	A	H	Gr	024250	€
153	40	105	400	024250	110,00

Portajamones
Ham support
Support jambons



Características:

Fabricado en una sola pieza, totalmente en acero inoxidable.
Su diseño consigue que cualquier jamón se acople con facilidad quedando firmemente sujeto.
Fácil limpieza. Al estar fabricado en acero inoxidable se puede introducir en máquinas de lavado y esterilización.
Tacos antideslizantes.



Characteristics:
One piece construction in stainless steel.
Its design allows an easy and firm fixing of any piece of ham.
Easy to clean, as it is made in stainless steel it can be washed in any washing or sterilizing device.
Anti-sliding plugs.

Caractéristiques:
Construit d'une seule pièce en acier inoxydable.
Son design permet accoupler facilement et solidement quelque jambon.
Facile à nettoyer puisque c'est construit en acier inoxydable et il est possible de l'introduire dans quelque appareil à laver ou à désinfecter.
Tampons anti-glissants.

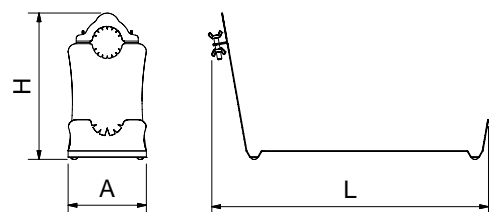

L	A	H	Kg	041802	€
510	270	144	2,7	041802	41,00

Jamonero para adosar a tajo con madera

Ham holder to fix to wooden chopping block
Porte-jambon pour adosser à un billot en bois



Características:

Fabricado en acero inoxidable AISI 304 este jamonero es especial para instalarlo en un tajo que contenga un bloque de madera.

Su diseño robusto y resistente, nos permite colocar el jamón en dos posiciones diferentes, una optimizada para el corte y otra para el deshuesado. Por lo que, si colocamos el jamón en el agujero superior, lo tendremos en la mejor posición para cortar y si lo colocamos en el agujero inferior, estará preparado para deshuesar.

Una de sus principales ventajas es que no ocupa espacio alguno en la superficie de trabajo, por lo que puede estar colocado todo el tiempo, estando en uso o no, sin suponer un estorbo.

Es fácil de instalar, ya que va atornillado en el bloque de madera.



Characteristics:

Made of AISI 304 stainless steel, this ham holder is special for installation in a wooden chopping block.

Heavy duty and robust design. Its design allows us to place the ham in two different positions, one optimized for cutting and another for boning. So, if we put the ham in the upper hole, we will have it in the best position to cut and if we place it in the lower hole, it will be prepared to bone.

One of its main advantages is that it does not occupy any space on the work surface, so it can be placed all the time, being in use or not, without supposing an obstacle.

It is easy to install, as it is screwed into the wooden block.

Caractéristiques:

Fabriqué en acier inoxydable AISI 304, ce porte-jambon est spécial pour installer sur un billot contenant un bloc en bois.

Sa conception robuste et résistante nous permet de placer le jambon dans deux positions différentes, l'une optimisée pour la découpe et l'autre pour le désossage. Donc, si nous mettons le jambon dans le trou supérieur, nous l'aurons dans la meilleure position pour le couper et si nous le plaçons dans le trou inférieur, il sera prêt pour le désosser.

L'un de ses principaux avantages est qu'il n'occupe aucun espace sur la surface de travail, il peut donc être placé tout le temps, qu'il soit utilisé ou non, sans supposer un obstacle.

Il est facile à installer, car il est vissé dans le bloc en bois.

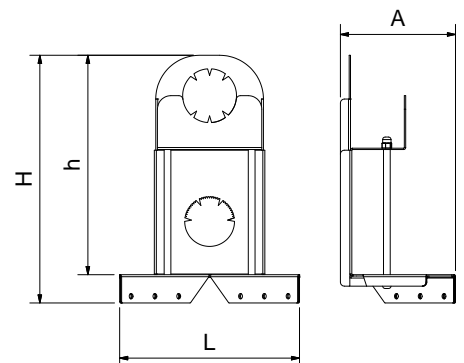

L	A	H	h	Kg	€
267	171	368	326	2,77	041820 167,00

Portalacones

Shoulder-ham holder
Porte Jambon de Pays

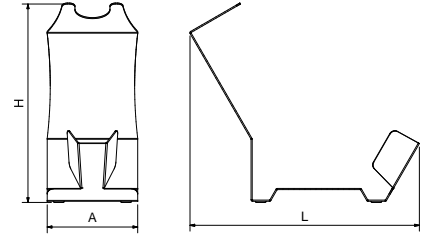

L	A	H	Kg	Barcode	€
393	155	340	2,2	041804	59,00

Mesa jamonera RT-2D

Ham table RT-2D
Table porte-jambon RT-2D



Características:

Con nuestros novedoso sistema de soporte RT podrá trasladar el jamón de la barra expositora al jamonero en un instante. Fácil intercambio del jamón a cortar. El útil de acoplamiento RT que incorpora está diseñado para colocar instantáneamente el jamón en el jamonero. Rotación 360° en dos dimensiones. Profesional, este sistema le ayudará a exponer mejor el jamón, colocándolo en la posición más adecuada en cada momento, favoreciendo la facilidad y efectividad del corte. Higiénico, al tener un solo punto de apoyo y quedar el jamón suspendido, las labores de limpieza se facilitan al máximo. Con nuestros útiles de acoplamiento RT puede tener varios jamones expuestos y preparados para cortar en cualquier momento.



Characteristics:

With our innovative RT support system you can move the ham from the display bar to the ham holder instantly. The ham is easily exchangeable. The built-in RT coupling tool is designed to instantaneously place the ham in the ham holder. Professional, this system will help you to display the ham better. In addition, you will be able to place it in the most appropriate position at each moment to cut it in an easy and effective way. 360° rotation in two dimensions. The ham is hold with one single supporting point, which results in an easy cleaning and better hygiene. With our RT coupling tools you can have several hams displayed and ready to cut at any time.

Caractéristiques:

Avec notre nouveau système de support RT, vous pouvez déplacer le jambon de la barre d'exposition au support de jambon en un instant. Facile échange de jambon à couper. L'outil de couplage RT intégré est conçu pour placer instantanément le jambon dans le porte-jambon. Rotation à 360° en deux dimensions. Professionnel, ce système vous aidera à mieux exposer le jambon, en le plaçant dans la position la plus appropriée à chaque moment, en favorisant la facilité et l'efficacité de la coupe. Hygiénique, n'ayant qu'un seul point d'appui et laissant le jambon suspendu, les tâches de nettoyage sont facilitées au maximum. Avec nos outils de couplage RT, vous pouvez avoir plusieurs jambons exposés et prêts à couper à tout moment.

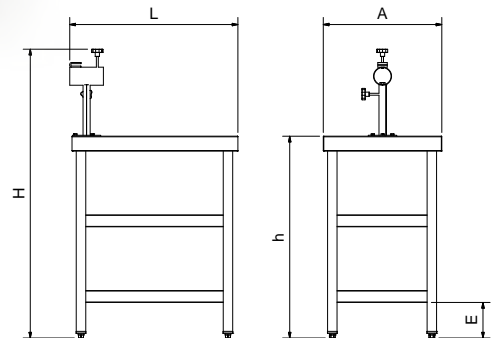

L	A	H	h	E	Kg	Barcode	€
710	500	1.220	850	150	20,00	074486	615,00

Mesa jamonera RT-3D
 Ham table RT-3D
 Table porte-jambon RT-3D

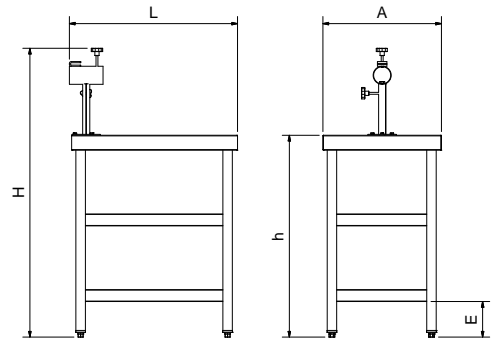

L	A	H	h	E	Kg	Barcode	€
710	500	1.220	850	150	20,00	074487	695,00



074490 175

Kits de portarrollos de papel o film serie Eco
 Set of paper or film dispenser, Eco series
 Kit de porte-rouleaux du papier ou film serie Eco



020102 37

Kit para colgar utensilios
 Tool-holder kit
 Kit pour suspendre outils



485002 497

Ruedas acopladas
 Wheels
 Rouelles



085480 494

Cajón o tolva acoplado
 Drawer or hopper coupled
 Tiror ou trémie accouplé

Punto de venta portátil de jamones

Mobile sale point of hams

Point de vente de jambon portable



Características de fabricación:

- Ruedas de $\varnothing 75$ mm.
- 2 cajones pequeños
- 1 cajón grande
- 2 puertas abatibles
- 1 contenedor verde 486026
- 1 Portacuchillos con envoltivo
- 1 Dispensador de 1 caja de guantes
- 1 Dispensador de papel y bolsas triple
- 1 Kit portarrollos
- 1Pletina de 1500 mm. con 12 ganchos para jamones
- 1 base de jamonero giratorio basculante RT-3D
- 3 jamoneros giratorios RT-2D
- 1 fibra negra de 500x465x20 mm. con agujero de desbarasado
- Espacio disponible para báscula



Manufacturing characteristics:

- Wheels $\varnothing 75$ mm.
- 2 small drawers
- 1 large drawer
- 2 folding doors
- 1 green container 486026
- 1 Knife holder with casing
- 1 Dispenser for 1 glove box
- 1 Triple dispenser for paper and bags
- 1 Roll holder kit
- 1 1.500 mm bar with 12 hooks for hams
- 1 foot of tilting rotating ham holder RT-3D
- 3 rotary ham holders RT-2D
- 1 black cutting board of 500x465x20 mm with hole for disposals
- Enough room for a scale

Caractéristiques de fabrication:

- Roues $\varnothing 75$ mm.
- 2 petits tiroirs
- 1 grand tiroir
- 2 portes ouvrantes
- 1 container vert 486026
- 1 Porte-couteau avec enveloppant
- 1 Distributeur de 1 boîte à gants
- 1 Distributeur triple papier et sac
- 1 Kit de support de rouleau
- 1 Plaque de 1500 mm. avec 12 crochets pour les jambons
- 1 base de porte-jambon rotatif basculant RT-3D
- 3 porte-jambons rotatifs RT-2D
- 1 plaque noire de 500x465x20 mm. avec trou pour déchets
- Espace disponible pour la balance.

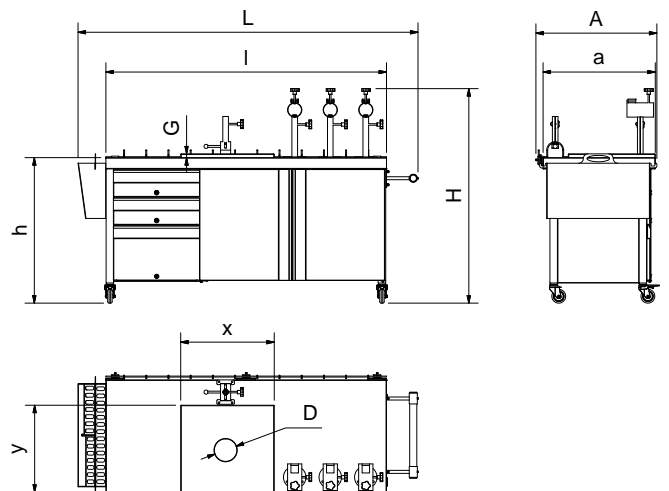

L	I	A	a	H	h	X	Y	G	D	Kg	Barcode	€
1.815	1.500	645	600	1.150	780	500	465	20	120	98,00	075230	3.310,00

Estante abatible de fibra para punto de venta portátil de jamones

Polyethylene hinged shelf for mobile sale point of hams

Étagère ouvrante en fibre pour point de vente de jambon portable

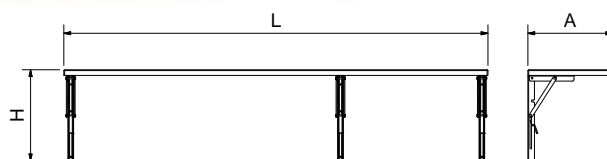

L	A	H	Kg	Barcode	€
1.500	300	325	10,3	075232	306,00

Plafones para exposición de embutidos

Sausage display boards

Panels d'exposition pour charcuterie



Gancho opcional 9200606022502
Optional hook 9200606022502.
Crochet optionnel 9200606022502.



46

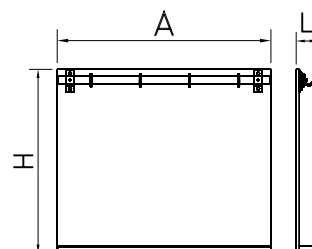

A	L	H	Nº Ganchos Hooks Crochets	Kg	Barcode	€
800	110	865	3	10	024202	195,00
1.000	110	865	4	11	024204	270,00
1.500	110	865	5	15	024206	290,00

Cono recoge grasas antigoteo para jamón

Anti-drip drain cone for ham grease

Cône pour récupérer la graisse, anti-goutte pour le jambon



Pack de 25 unidades.
Pack of 25 units.
Pack de 25 unités.

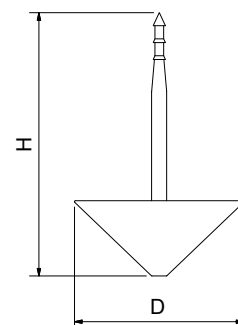

H	D	Gr	Barcode	€
140	90	150	9403801445602	35,00



Set para corte de jamón

Ham slicing set
Set pour couper le jambon



Complete set of tools for slicing ham consisting of:
Carrying bag with provided with lodging for each knife along with slots for business cards, pens, etc.
Sharpener (ref. 447202).
Ham tweezers.
Ham knife (length of blade 290 mm).
Ham boning knife.

Ensemble complet d'outils pour la découpe du jambon qui inclus:
Sac de transport avec logement pour chaque couteau, ainsi que des volets pour les cartes de visite, stylos, etc.
Fusil à affûter 447202.
Pince à jambon.
Couteau à trancher (longueur de la lame 290 mm).
Couteau à jambon de désossage.

Completo set de herramientas para el corte de jamón que incluye:

Bolsa de transporte con alojamiento para cada cuchillo, además de solapas para tarjetas de visita, bolígrafos, etc.

Chaira 447202.

Pinza jamonera.

Cuchillo jamonero (largo de hoja 290 mm).

Cuchillo deshuesador de jamón.

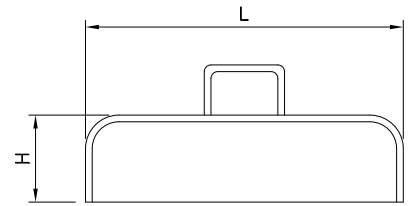

L	H	Gr	Barcode	€
475	135	740	448062	41,50

AD

Jamón serrano virola

Ferrule slicing knife for cured ham
Couteau à jambon de montagne à virole

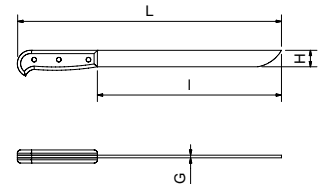

L	I	H	G	Tipo Type Type	Gr	Barcode	€
380	260	22	2,00	↑	135	445402	33,00
460	310	22	2,16	↑	150	445406	38,50

Jamón serrano

Slicing knife for cured ham
Couteau à jambon de montagne

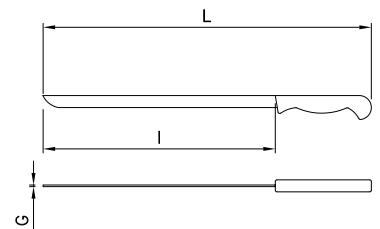
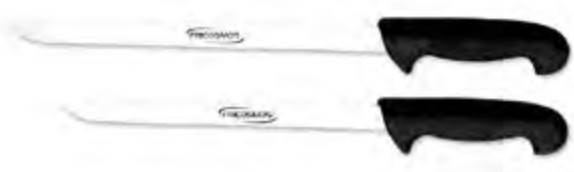

L	I	H	G	Tipo Type Type	Gr	Barcode	€
390	250	20	1,5	STD	105	445202	13,00
440	300	20	1,6	STD	120	445204	15,00

Jamón serrano punta redonda
 Knife for cured ham, round tip
 Couteau à jambon avec pointe ronde

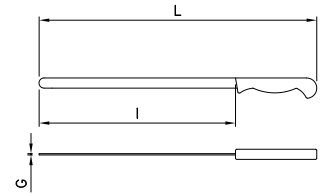

L	I	H	G	Tipo Type Type	Gr	Barcode	€
300	32		2,5	STD	160	440460	18,50

Jamón serrano alveolado punta redonda
 Fluted slicing knife for cured ham, round tip
 Couteau alvéolé pour jambon de pays avec pointe ronde

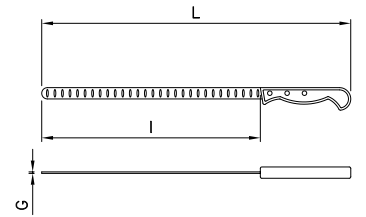
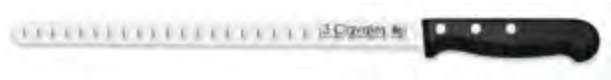

L	I	H	G	Tipo Type Type	Gr	Barcode	€
410	290		1,5	STD	115	445206	24,50

Gubia deshuesar jamón
 Ham boning gouge
 Gouge à désosser jambon

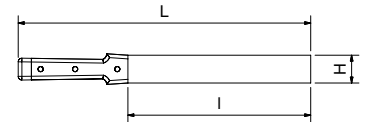

L	I	H	Tipo Type Type	Gr	Barcode	€
385	240	40	STD	370	444602	53,00

Deshuesar jamón
 Ham boning knife
 Désosseur jambon

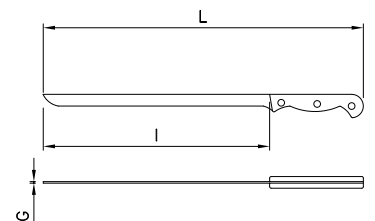

L	I	H	G	Tipo Type Type	Gr	Barcode	€
340	205	22	3,2	STD	140	445802	19,00
435	300	25	3,0		165	445806	22,00

Deshuesar jamón
Ham boning knife
Désosseur jambon

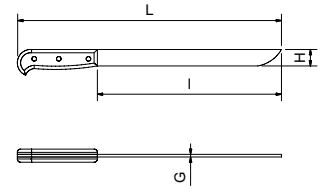

				Uso general General use Usage generale	Aves Poultry Volailles	Pescados Fish Poissons	Frutas y verduras Fruits & Vegetables Fruits et légumes	Carnes Meat Viandes			
L	I	H	G	Tipo Type Type	Gr	€					
270	130	20	2,43		115	10,00	445850	445882	445858	445874	445866
290	150	23	2,45	STD	120	10,50	445852	445884	445860	445876	445868

Deshuesar jamón curvo
Ham curved boning knife
Désosseur jambon courbe

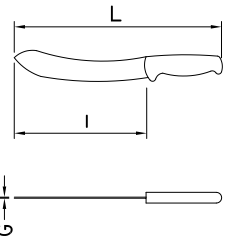

L	I	H	G	Tipo Type Type	Gr	€
300	170	31	2,5	STD	118	12,00

Pinzas para embutidos
Meat tongs
Pincas saucisse

		L	A	Gr	€
		200	5	25	440068 7,00
		120	100	15	440070 8,00
		100	50	120	440030 11,00



Cuchillería profesional para pescaderos

Professional cutlery for fishmongers
Coutellerie professionnelle pour poissonniers

Pescadero

Fish knife
Couteau à poisson

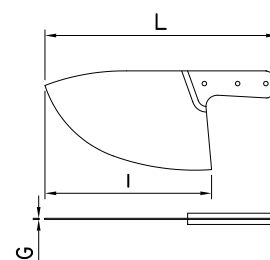

	L	I	H	G	Tipo Type Type	Gr	Barcode	€
	420	305	190	1,53	†	670	446002	86,00
	460	340	190	1,53	†	735	446004	83,00
	475	355	200	1,53	†	790	446006	91,00
	495	375	215	1,73	†	850	446008	112,50
	440	320	105	1,76	STD	555	446202	53,50
	470	340	120	1,72	STD	650	446204	58,50
	490	360	135	1,90	STD	725	446206	64,00
	420	290	105	1,4	STD	480	446012	60,00
	415	300	120	1,5	STD	520	446014	65,00
		280	74	3,0	STD	284	446220	34,00

Escamador

Scale removers
Ecailleurs

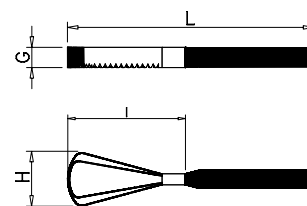

L	I	H	G	Gr	Barcode	€
270	95	60	20	215	040202	21,00

Escamador EC
Scale removers EC
Ecailliers EC

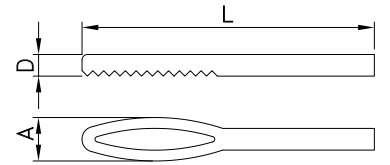

L	A	D	Gr	Barcode	€
265	40	22	180	440052	7,50

Bacaladera
Cod knife
Couteau à morue

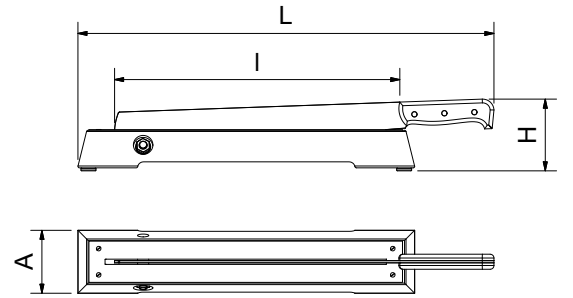

L	A	H	I	Gr	Barcode	€
550	85	110	300	2.185	446602	144,50

Abreostras
Oyster opener
Ouvre-huîtres



⚠ Se fija a la mesa mediante mordaza.
Table fixing by clamp.
Fixation au table sur mordache.

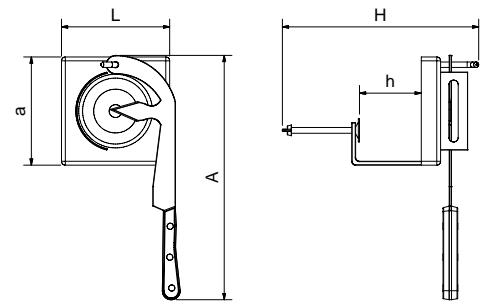

L	A	a	H	h	Kg	Barcode	€
140	325	140	250	75	1,16	447802	153,50

Abreostras
Oyster opener
Ouvre-huîtres

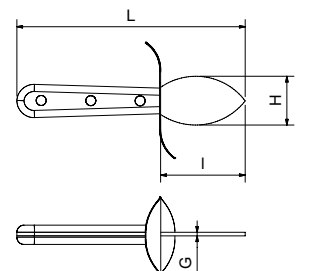

L	I	H	G	Gr	Barcode	€
165	65	85-32	2,4	120	447804	17,50

Abre ostras de polietileno
Polyethylene oyster opener
Ouvre-huîtres en polyéthylène

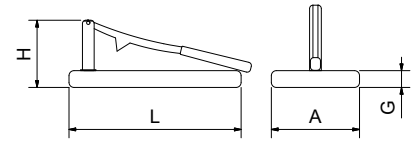

L	A	H	G	Kg	Barcode	€
205	105	80	20	1,6	447806	39,50

Abre ostras manual profesional en acero inoxidable
Professional manual oyster opener in stainless steel
Ouvre-huîtres manuel professionnel en acier inoxydable

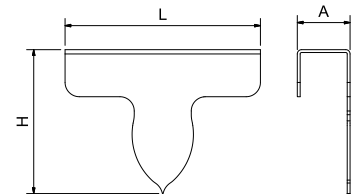

L	A	H	Gr	Barcode	€
137	37	101	250	040250	8,00

Abre ostras profesional de sobremesa en acero inoxidable
Professional tabletop stainless steel oyster opener
Ouvre huîtres professionnel sur table en acier inoxydable

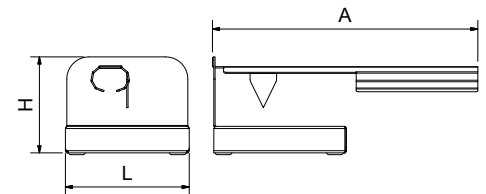

L	A	H	Gr	Barcode	€
140	300	110	890	040252	39,00

Detector de anisakis
Anisakis detection kit
Kit détection Anisakis



Este novedoso y patentado sistema permitirá detectar el Anisakis y otros parásitos de forma sencilla, tanto en pescaderías como plantas procesadoras de pescado.

This innovative and patented system will allow the detection of Anisakis and other parasites in a simple way, both in fishmongers and fish processing plants.

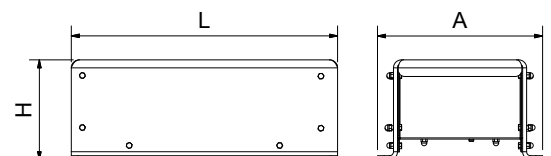

L	A	H	Tensión Voltage Tension	Frecuencia Frequency Fréquence	Kg	Barcode	€
400	248	155	220/240V	50/60 Hz	2,96	042802	218,00

Ce système novateur et breveté permettra la détection des Anisakis et autres parasites de manière simple, aussi bien dans les poissonneries que dans les usines de transformation du poisson.



Cuchillería profesional para cocineros
Professional cutlery for cooks
Coutellerie professionnelle pour chefs

AD



CUCHILLERÍA PREMIUM
PREMIUM CUTLERY
COUTELLERIE PREMIUM

Cuchillería forjada
Forged knives
Couteaux forgé

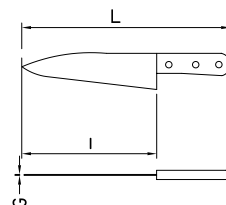

L	I	H	G	Tipo Type	Gr	Barcode	€
255	150	30	2,80		115	440204	32,00
340	200	47	2,11		246	440206	40,00
370	250	50	3,40		280	440208	51,00
430	295	55	3,50		375	440210	69,00
490	350	65	3,60		500	440212	89,00

Cocinero forjado
Forged chef knife
Couteau cocineto forgé

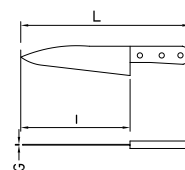

L	I	H	G	Tipo Type	Gr	Barcode	€
240	130	20	1,7		91	440202	7,16

Pelador forjado
 Forged paring knife
 Couteau éplucheur forgé

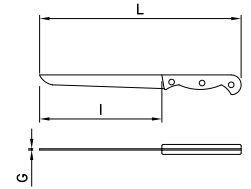

L	I	H	G	Tipo Type	Gr	Barcode	€
205	90	20	1,7		87	444220	7,06

Panero forjado
 Forged bread knife
 Couteau à pain forgé

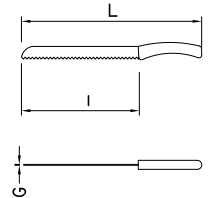

L	I	H	G	Tipo Type	Gr	Barcode	€
330	200	28	2		174	448010	9,78

Trinchar forjado
 Forged carving Knife
 Couteau à découper forgé

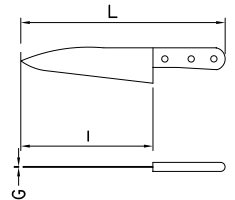

L	I	H	G	Tipo Type	Gr	Barcode	€
335	200	28	2		165	440250	9,44

Deshuesar forjado
 Forged boning Knife
 Couteau à désosser forgé

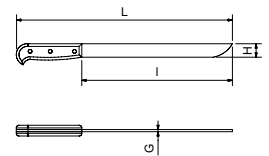

L	I	H	G	Tipo Type	Gr	Barcode	€
290	160	25	2		148	445830	9,13

Cocina alveolado
 Fluted kitchen knife
 Cuisine alvéolée

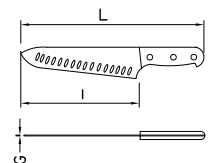

I	H	G	Tipo Type	Gr	Barcode	€
250	50	2,5		290	440430	41,00



Características de fabricación:

SEGURIDAD EN UN DISEÑO PROBADO. Hace más de 30 años, ZWILLING J.A. HENCKELS revolucionaba los estándares para los cuchillos de cocina de alta calidad al crear el mango sintético sin juntas.

- Material de mango: sintético.
- Transición sin juntas del cabezal al mango.
- Acero inoxidable y fundición especial.
- Hoja endurecida al frío con FRIODUR.
- Cuchillos SIGMAFORGE hoja forjada de una única pieza.

Manufacturing characteristics: SAFETY IN A PROVEN DESIGN. More than 30 years ago ZWILLING J.A. HENCKELS revolutionised the standards for top-quality knives with this seamless synthetic handles.

- Handle material: synthetic.
- Seamless transition from bolster to handle.
- Stainless steel and special smelting.
- FRIODUR knife, ice-hardened.
- SIGMAFORGE knife - forged from one piece.

Caractéristiques de fabrication: LA SECURITE D'UN MODELE QUI A FAIT SES PREUVES. Il y a plus de 30 ans, ZWILLING J.A. HENCKELS révolutionna les normes des couteaux de qualité optimale avec ces manches synthétique homogènes.

- Manche: synthétique.
- Transition homogène entre la mitre et le manche.
- Acier inoxydable unique, formule spéciale.
- Couteau FRIODUR en acier trempé.
- Couteau SIGMAFORGE - forgé d'une seule pièce.

Puntilla

Paring knife
Couteau d'office

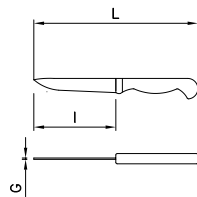

L	I	H	G	Tipo Type	Gr	Barcode	€
205	100	20	1,0		54	447302	73,00

Universal dentado

Universal knife
Couteau universel

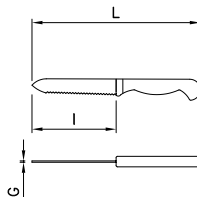

L	I	H	G	Tipo Type	Gr	Barcode	€
230	130	20	1,0		58	447304	65,00

Filetear

Fillet knife
Filet de couteau

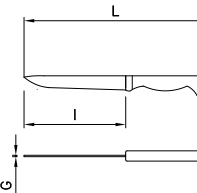

L	I	H	G	Tipo Type	Gr	Barcode	€
290	160	29	1,0		112	447306	79,00
318	200	29	2,0		122	447308	88,00
370	260	29	2,0		144	447310	109,00

Jamonero

Ham knife
Couteau à jambon

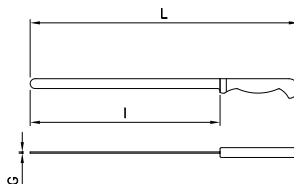

L	I	H	G	Tipo Type	Gr	Barcode	€
431	300	17	2,0		148	447312	125,00

Cebollero

Onion knife
Couteau oignon

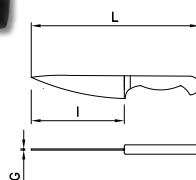

L	I	H	G	Tipo Type	Gr	Barcode	€
329	200	41	3,0		212	447314	109,00

Cuchillería Victorinox

Victorinox knives
Couteaux Victorinox



Características de fabricación:
Los cuchillos profesionales de Victorinox se caracterizan por sus resistentes materiales de primera calidad que se adaptan a la mano y se ajustan con precisión a cada aplicación. La dureza correcta de la hoja y el ángulo de corte controlado por láser garantizan una elevada eficiencia de corte.

Manufacturing characteristics:
The professional knives Victorinox are characterized by their durable materials of first quality. They fit the hand and conform precisely to each use. The right blade hardness and the laser-tested cutting angle guarantee high cut efficiency.

Caractéristiques de fabrication:
Les couteaux professionnels Victorinox sont caractérisés par leurs matériaux durables et de première qualité. Ils s'ajustent à la main et de s'adaptent parfaitement à chaque utilisation. La correcte dureté de lame et l'angle de coupe contrôlé par laser garantit coupe à haut rendement.

Salmón

Salmon knife
Couteau à saumon

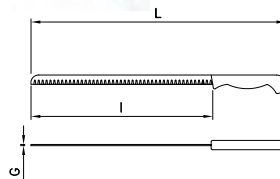

L	I	H	G	Tipo Type	Gr	Barcode	€
442	300	21	1,8	STD	150	445902	75,00

Despellejar

Skinning knife
Ecorcheur

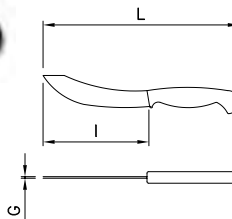

L	I	H	G	Tipo Type	Gr	Barcode	€
282	150	37	2,0	STD	130	445904	40,00

Deshuesar

Boning knife
Couteau à désosse

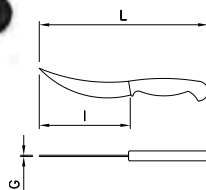

L	I	H	G	Tipo Type	Gr	Barcode	€
282	150	22	2,5	STD	125	445914	31,00

Carnicero

Butcher
Boucher

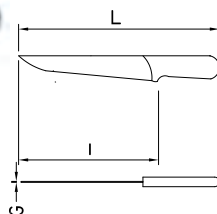

L	I	H	G	Tipo Type	Gr	Barcode	€
297	160	36	2,5		125	445906	40,00
337	200	36	2,5	STD	170	445908	53,00
397	260	51	2,5		220	445910	59,00

Fileteador flexible

Flexible filleting knife
Couteau à filet flexible

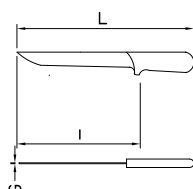







L	I	H	G	Tipo Type	Gr	Barcode	€
340	210	20	1,5	STD	135	445912	45,00

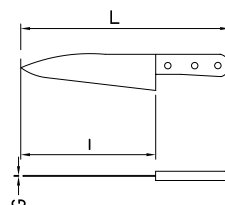

CUCHILLERÍA ESTANDAR
STANDARD CUTLERY
COUPELLERIE STANDARD

Modelo cocina
Chef knives
Modèle chef

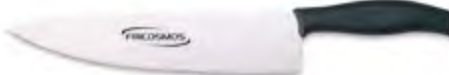

	L	I	H	G	Tipo Type Type	Gr	Barcode	€
	325	200	45	2,77		155	440450	18,00
	350	225	48	2,70	STO 	180	440452	20,00
	425	300	60	2,60		205	440454	26,00
	200	105	24	1,6		50	440400	9,00
	265	150	40	2,0		120	440402	13,00
	295	180	45	2,0		140	440404	15,00
	320	200	49	2,8		190	440406	18,00
	350	230	45	2,5	STO 	190	440408	21,00
	375	255	57	2,5		150	440410	22,50
	435	305	60	2,8		310	440412	28,50
	475	345	70	2,8		390	440414	26,50

Cuchillo todos usos

Multipurpose Knife
Couteau tous usages

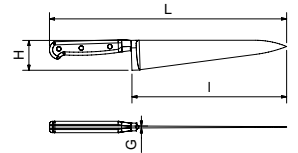

				Uso general General use Usage generale	Aves Chickens Volailles	Pescados Fish Poissons	Frutas y verduras Fruits & Vegetables Fruits et légumes	Carnes Meat Viandes			
L	I	H	G	Tipo Type	Gr	€	Barcode	Barcode	Barcode	Barcode	Barcode
310	175	35	2,6		135	12,50	444002	444074	444020	444056	444038
325	190	60	2,6		160	17,00	444004	444076	444022	444058	444040
355	220	40	2,6	STD	190	19,50	444006	444078	444024	444060	444042
380	250	50	2,6		210	20,50	444008	444080	444026	444062	444044
430	305	50	2,6		275	24,00	444010	444082	444028	444064	444046
485	350	55	2,6		330	31,00	444012	444084	444030	444066	444048

AD

Cuchillo cocinero con filo dentado

Double shopping trolley bay
Parking double pour caddies

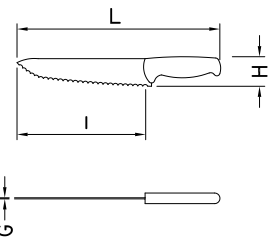

L	I	H	G	Tipo Type	Gr	Barcode	€
310	200	45	1,8	STD	120	440440	28,00

Lenguado

Fish fillet knife
Sole

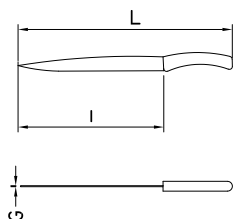

L	I	H	G	Tipo Type	Gr	Barcode	€
290	170	25	1,4	STD	115	446050	29,00

Cuchillo antioxidante para verduras
 Anti-oxidation knife for vegetables
 Couteau antioxydant pour légumes



L	I	H	G	Gr	Barcode	€
300	190	40	2	65	440066	3,00

Santoku
 Santoku knife
 Couteau Santoku

L	I	H	G	Tipo Type	Gr	Barcode	€
300	180	36	2,0	STD †	160	447116	11,50
180	52	2,5	STD †	176	447126	23,00	

Pelador
 Peeling knife
 Éplucheur



L	I	H	G	Tipo Type	Gr	Barcode	€
170	65	20	1,53	STD †	35	444204	6,00

Puntilla
 Dagger
 Proignard



L	I	H	G	Tipo Type	Gr	Barcode	€
215	100	21	1,8	STD †	50	444404	8,00
280	150	40	1,8	STD †	60	444406	11,50

Cortar pan
Bread knife
Couteau à pain

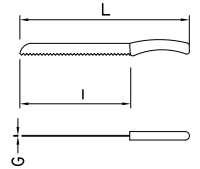

L	I	H	G	Tipo Type	Gr	Barcode	€
345	215	25	1,8	STD	110	448002	12,50

Cuchillo panero de mango elevado y filo ondulado
Wavy edge bread knife, elevated handle
Couteau à pain à manche haut avec bord ondulé

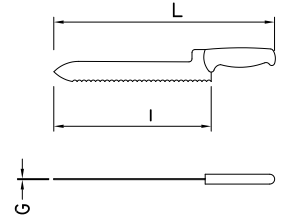

L	I	H	G	Tipo Type	Gr	Barcode	€
360	230	50	1,2	STD	120	448006	28,00

Cuchillo panero especial pizza
Bread knife, special for pizza
Couteau à pain spécial pizza

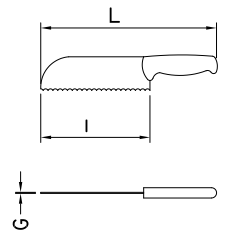

L	I	H	G	Tipo Type	Gr	Barcode	€
280	160	45	1,9	STD	120	448008	30,00

Cuchillo especial alimentos congelados
Frozen food knife
Couteau spécial pour aliments surgelés

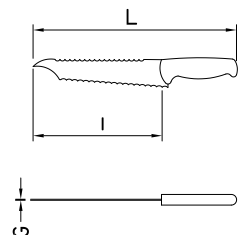

L	I	H	G	Tipo Type	Gr	Barcode	€
380	260	33	2,2	STD	130	448040	40,50

Cuchillería titanio

Titanium knives
Couteaux titane



Deshuesador

Boning knife
Désosseur

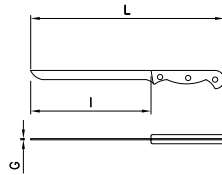

I	H	G	Tipo Type	Gr	Barcode	€
150	20	1,8	STO	96	446518	23,50

Cocinero

Chef knife
Couteau de cuisine

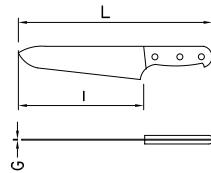

I	H	G	Tipo Type	Gr	Barcode	€
200	50	2,5	STO	207	446502	46,00

Verduras

Vegetable knife
Légumes

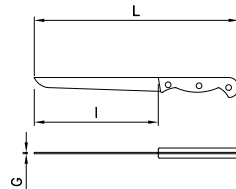

I	H	G	Tipo Type	Gr	Barcode	€
130	23	1,8	STO	54	446528	17,00

Jamonero

Ham knife
Couteau à jambon

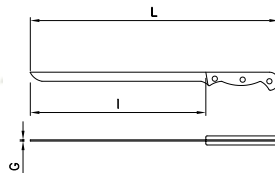

I	H	G	Tipo Type	Gr	Barcode	€
300	25	1,8	STO	122	446520	36,00

Santoku

Santoku knife
Couteau Santoku

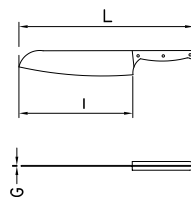

I	H	G	Tipo Type	Gr	Barcode	€
180	50	2,5	STO	176	446522	37,00

Panero

Bread knife
Couteau à pain

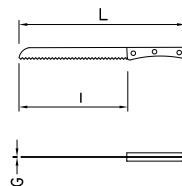

I	H	G	Tipo Type	Gr	Barcode	€
320	25	2,5	STO	147	446524	29,00

Salmón

Salmon knife
Couteau à saumon

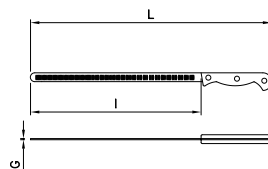

I	H	G	Tipo Type	Gr	Barcode	€
300	30	2,5	STO	177	446526	58,00

Cuchillería con revestimiento antiadherente ILAFLON RESIST™

Knives with nonstick coating ILAFLON RESIST™

Couteaux à revêtement antiadhésif ILAFLON TM RESIST™



Características de fabricación:

Sistema de revestimiento antiadherente ILAFLON RESIST™, bi-capa de alta resistencia, con refuerzo cerámico.

Estas dos capas se combinan de forma óptima para crear una película que presenta un excelente efecto antiadherente, de esta forma se consigue que el corte se desprenda fácilmente de la hoja.

- Anti-adherente
- Mayor agilidad al cortar
- Anti-corrosión
- Anti-manchas
- Mejor desinfección y limpieza

Manufacturing characteristics:

ILAFLON RESIST™: Nonstick coating system ILAFLON RESIST™, with high strength two-layer coating and ceramic reinforcement.

These two layers are combined in an optimal way in order to create a film with an excellent nonstick effect. In this way any cut you make will be detached from the blade easily.

- Nonstick.
- Cutting agility.
- Anti-corrosion.
- Stain-resistant.
- Better sanitation.

Caractéristiques de fabrication:

ILAFLON TM RESIST™: Système de revêtement antiadhésif ILAFLON RESIST™, avec haute résistance à deux couches de revêtement et renforcement de céramique.

Ces deux couches sont combinées de manière optimale afin de créer un film avec un effet anti-adhésif excellent. De cette façon, toute tranche que vous faites sera détachée de la lame facilement.

- Revêtement antiadhésif.
- Agilité de coupe.
- Anti-corrosion.
- Résistant aux taches.
- Meilleur assainissement.

AD

Puntilla Paring knife Couteau d'office

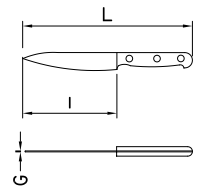

L	I	H	G	Tipo Type	Gr	Barcode	€
210	100	21	1,5	STD ↑	51	446702	16,00

Cocinero Chef knife Couteau de cuisine

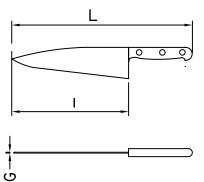

L	I	H	G	Tipo Type	Gr	Barcode	€
320	200	49	3,0	STD ↑	203	446704	40,00
370	250	53	3,0		263	446706	50,00
420	300	67	3,0		441	446708	86,00

Panero Bread knife Couteau à pain

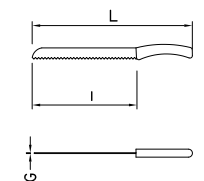

L	I	H	G	Tipo Type	Gr	Barcode	€
330	200	29	2,0	STD ↑	144	446710	33,00

Jamonero Ham knife Couteau à jambon

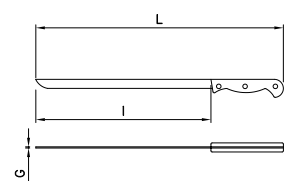

L	I	H	G	Tipo Type	Gr	Barcode	€
410	300	15	1,8	STD ↑	95	446712	32,00

Cuchillería cerámica

Ceramic knives
Couteaux en céramique



Cocina

Kitchen chef's knife
Couteau chef

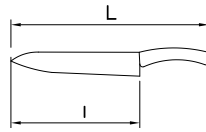

L	I	H	Tipo Type	Gr	Barcode	€
270	150	35		107	446116	13,00
295	175	40	STD	138	446118	17,00
320	200	43		154	446120	21,00

Panero

Bread knife
Couteau à pain

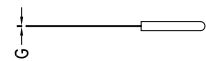
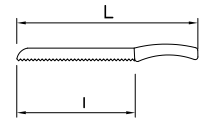

L	I	H	Tipo Type	Gr	Barcode	€
275	155	30	STD	104	446114	15,00

Santoku

Santoku knife
Couteau Santoku

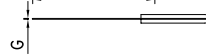
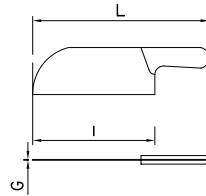

L	I	H	Tipo Type	Gr	Barcode	€
225	123	33	STD	169	446112	13,50

Puntilla

Dagger
Proignard

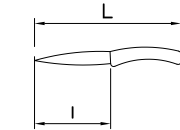

L	I	H	Tipo Type	Gr	Barcode	€
175	75	20		39	446106	7,00
200	100	20	STD	43	446108	7,60

Utilitario

Utility
Utilitaire

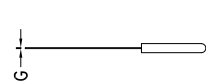
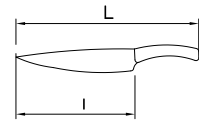

L	I	H	Tipo Type	Gr	Barcode	€
230	125	25	STD	58	446110	10,00

Pelador de cerámica

Ceramic peeler
Couteau éplucheur en céramique

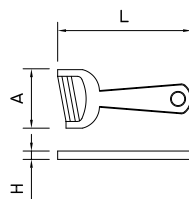

L	A	H	Gr	Barcode	€
---	---	---	----	---------	---









120 50 20 75 446122 **4,50**

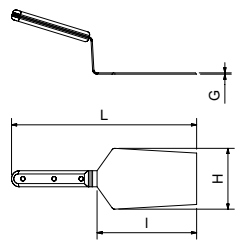

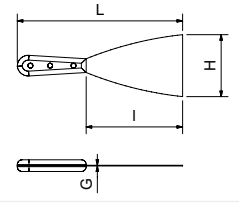
140 80 30 27,2 446124 **6,50**

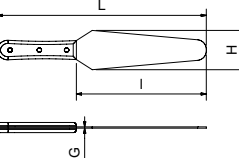
Paletas y espátulas
Grill turners and spatulas
Palettes et spatule

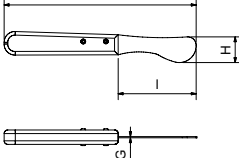
		L	I	H	G	Gr	Barcode	€
		290	160	95	2	320	441602	21,00
		230	130	95	1	115	441206	15,90
		215	125	26	1,0	65	441402	10,00
		255	155	26	1,0	70	441404	12,00
		335	205	40	1,0	170	441406	20,00
		385	255	45	1,0	190	441408	20,50
		440	315	45	1,5	205	441410	30,00
490	365	45	1,5	265	441412	31,00		
		160	65	23	1	35	441002	2,60

Aguja de mechar
Stuffing needle
Aiguille lardoire

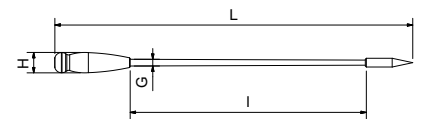

L	I	H	G	Gr	Barcode	€
200	130	10	6	100	440802	14,50

Tenedor de trinchar
Carving fork
Fourchette de chef

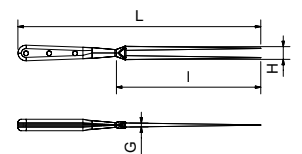

L	I	H	G	Gr	Barcode	€
300	170	16	5,4	150	440602	40,00

Tenedor trinchar EC
Carving fork EC
Fourchette de chef EC

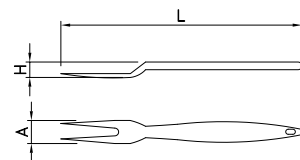

L	A	H	Gr	Barcode	€
320	60	40	100	440040	3,50

Pelador
Peeler
Éplucheur

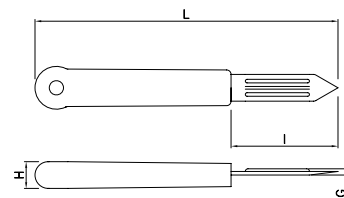

L	I	H	G	Gr	Barcode	€
215	75	20	3,65	54	446902	2,50

Pelador de espárragos
Asparagus peeler
Éplucheur d'asperges

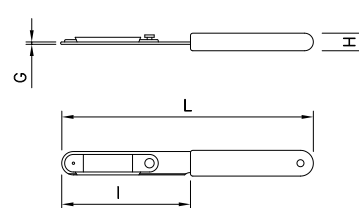

L	I	H	G	Gr	Barcode	€
215	107	10	3	55	446922	16,50

Rizador de mantequilla
Butter curler knife
Coquilleur à beurre

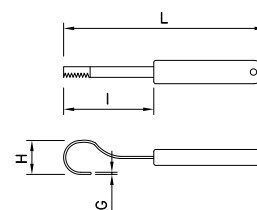

L	I	H	G	Gr	Barcode	€
190	84	10	2	53	446920	6,50

Rallador
Grater
Râpe

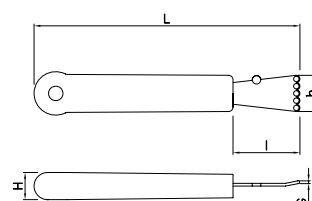

L	I	H	G	h	Gr	Barcode	€
180	45	20	2	20	54	446904	2,75

Acanalador
Canelle knife
Zesteur canneléur

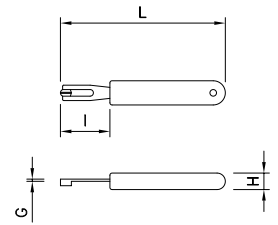

L	I	H	G	Gr	Barcode	€
150	44	10	2	41	446918	6,50

Vaciador doble
Melon baller scoop
Couteau à vider double

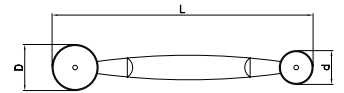

L	D	d	Gr	Barcode	€
170	30	22	53	446910	15,00

Descorazonador
Corer
Couteau carottier

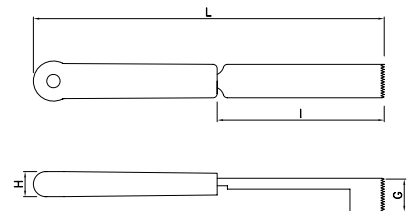

L	I	H	G	Gr	Barcode	€
215	80	15	19,6	55	446906	2,85

Decorador de fruta
V-shaped garnishing knife
Couteau décorateur de fruit

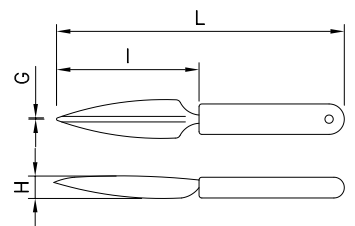

L	I	H	G	Gr	Barcode	€
210	105	15	2	54	446916	6,00

Decorador
Garnishing knife
Couteau à décorer

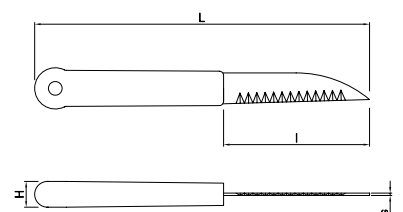

L	I	H	G	Gr	Barcode	€
190	85	17	1,5	36	446912	16,50

Set de decoración

Garnishing set
Décor set



Contenido del set de decoración:

5 cuchillos talladores.
Una esfera de \varnothing 20 mm. (melón)
Un cuchillo en forma de hoz.
Una chaira de cerámica.

Garnishing set content:

5 carving knives.
Melon baller
Sickle-shaped knife
Ceramic sharpener

Contenu du set:

5 couteaux à découper.
Cuillère à melon
Couteau faucille
Fusil à aiguiser en céramique



210 448058 **98,00**

Tomate

Tomato knife
Couteau à tomate

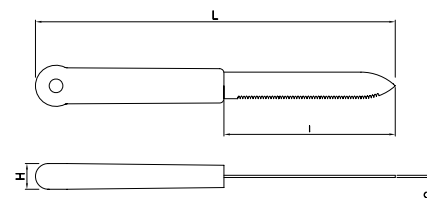

L I H G **Gr** 446914 **3,50**

Cuchillo cortador de tajadas de sandía o melón

Watermelon or melon slicer knife
Couteau spécial tranche de pastèque ou melon

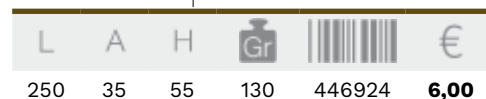
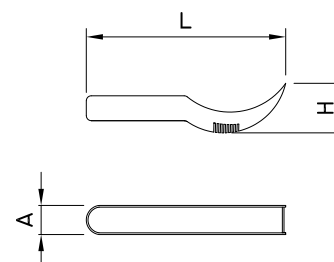

L A H **Gr** 446924 **6,00**



Aplastafiletas circular

Meat pounder with round handle
Aplatisseur ronde

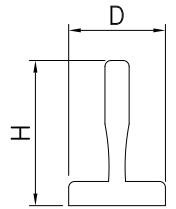

H	D	Gr	Barcode	€
120	80	2.000	441806	55,00

Aplastafiletas

Filet flattener
Ecrasse-steak

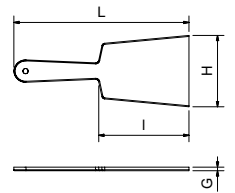

L	I	H	G	Gr	Barcode	€
270	135	110	5,5	685	441802	46,00
340	120	100	9,0	1.155	441804	88,00

Recoge verduras

Vegetable plate
Plaque de légumes

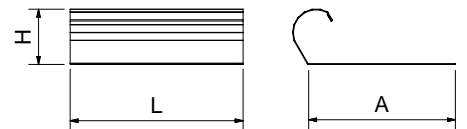

L	H	A	Gr	Barcode	€
175	56	150	350	040220	13,00

Kit de útiles para barbacoa

BBQ utensil set
Kit d'accessoires pour barbecue

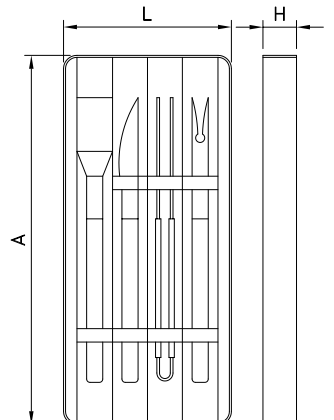

L	A	H	Gr	Barcode	€
550	250	50	950	440062	77,00

Tijeras

Scissors
Ciseaux

Tijeras pescadero

Fish scissors
Ciseaux à poisson

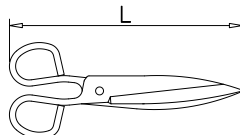

L	Gr	Barcode	€
200	155	446806	9,00
220	200	446808	6,50
240	260	446810	22,00
260	340	446812	26,00
280	415	446814	36,00

Tijera pescadero / cocina con protección

Kitchen / fish scissors with protection
Ciseaux de poissonniers / de cuisine avec protection

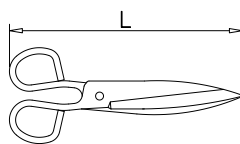

L	Gr	Barcode	€
210	260	446816	4,50

Tijeras de trinchar

Chicken scissors
Couteau à poulets

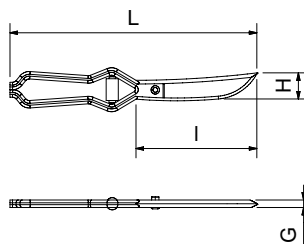

L	I	H	G	Gr	Barcode	€
260	125	20	10	270	446850	18,00

Tijera desmontable multiusos

Detachable multi-purpose scissors
Ciseaux multi-usages démontables

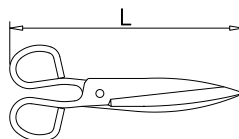

L	Gr	Barcode	€
200	160	446854	31,00

Tijeras multiusos

Multi purpose scissors
Ciseaux multi-usages

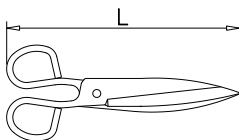

L	Gr	Barcode	€
215	160	446852	20,00

Tijera profesional

Professional scissors
Ciseaux professionnelles

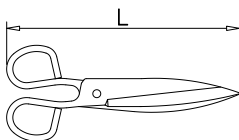

L	Gr	Barcode	€
210	290	446856	44,50



Afiladores Knife-sharpener Aiguiseur

AD

Chairas

Sharpening steel
Fusil à affûter

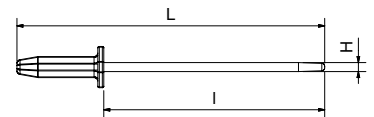

L	I	H		Gr			€
440	305	11		360	○	447202	22,00
430	305	10		340	○	447210	26,00
430	305	10		340	○	447212	26,00
440	305	20-10		380	○	447204	28,00

Chaira cerámica

Sharpening ceramic
Fusil à aiguiser en céramique



Sus principales ventajas son su ligereza y una mayor vida útil frente al resto de chairas.

Fabricada con cerámica de alta y avanzada tecnología.

Recomendada para cuchillos fabricados con aceros y aleaciones especiales de cuchillería, como molibdeno-vanadio, CROMOVA 18, etc. No válida para cuchillos cerámicos.

Excelente resultado del afilado.

Its main advantages are its lightness and durability compared with other sharpeners.

Made of high and advanced technology ceramic.

Recommended for knives manufactured with steel and special alloys for knives, such as molybdenum-vanadium, CROMOVA 18, etc. It is not valid for ceramic knives.

Excellent sharpening results.

Ses principales avantages sont sa légèreté et de durabilité par rapport à d'autres taille.

Fabriqué en céramique de haute et avancée technologie.

Recommandé pour les couteaux fabriqués avec des aciers et alliages spéciaux, tels que le molybdène vanadium, CROMOVA 18, etc Il n'est pas valable pour les couteaux en céramique.

Excellente netteté des résultats.



L	I	H	Gr			€
375	250	15	200	○	447206	30,00

Chaira diamantada

Diamond sharpening steel
Fusil à aiguiser diamanté



Su principal ventaja es la posibilidad de afilar todo tipo de **cuchillos**, incluso los **cerámicos**.

La hoja de acero cubierta de diamante en polvo permite obtener un resultado particularmente fino de afilado. La capa de diamante se desgasta con el tiempo, acortando poco a poco la vida útil del utensilio. Se recomienda utilizarla complementariamente a la chaira de acero.

El mango inyectado en polipropileno proporciona gran ergonomía a la vez que firmeza en la sujeción, con diseño protector y anilla para colgar.

Ses principales avantages est la possibilité d'affûter tous les types de **couteaux**, même les **céramiques**.

La lame en acier recouvert de poudre de diamant à la suite d'un aiguisage de la lame particulièrement fin. La couche de diamant s'use au fil du temps, le raccourcissant progressivement la durée de vie de l'outil. Il est recommandé de l'utiliser en alternance avec le fusil à aiguiser en acier.

La poignée en polypropylène injecté offre une grande ergonomie avec fermeté à saisir et une conception de protection. Fourni avec anneau de suspension.

Its main advantage is the possibility of sharpening all kind of **knives**, even the **ceramic** ones.

The steel blade covered with diamond powder has as a result a especially fine blade sharpening. The diamond layer wears out over time, shortening gradually the life of the tool. It is recommended to use it alternatively with the steel sharpener.

The injected polypropylene handle offers a great ergonomics together with firmness in gripping, a protective design. Provided with hanging ring.

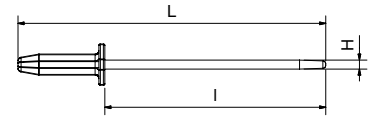

L	I	H	Gr		€
440	305	20>10	295	447208	25,00

Piedra de afilar de mano

Hand sharpening stone
Pierre à aiguiser manuelle

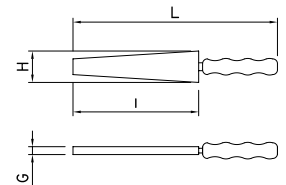

L	I	H	G	Gr		€
240	120	40	15	123	448316	4,50

Piedra para afilar cuchillos al agua 240/320

Water grindstone 240/320 for knives
Pierre à aiguiser à base d'eau 240/320

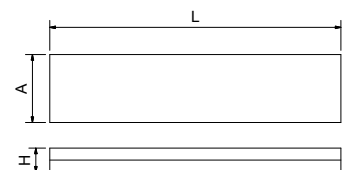

L	A	H	Gr		€
200	50	25	480	448318	6,00

Afilador cuchillos manual de sobremesa

Manual knife-sharpener for worktop
Aiguseur manuel sur table

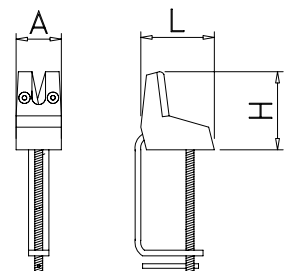

L	A	H	Gr		€
60	66	40	380	448304	124,00

Cuchillas de repuesto para afilador 448304

Spare blades for knife-sharpener 448304
Lames de rechange pour l'affûteur 448304

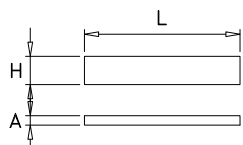

Juego de 4 cuchillas, 2 gomas protectoras grandes (63x48 mm.) y 1 goma protectora pequeña (45x20 mm.)
Set of 4 blades, 2 large protective rubbers (63x48 mm) and 1 small protective rubber (45x20 mm.)
Ensemble de 4 lames, 2 caoutchoucs de protection grandes (63x48 mm.) et un caoutchouc de protection petite (45x20 mm.)

L	A	H	Gr		€
33	2	6	33	448354	66,00

Afilador de cuchillos manual de sobremesa

Manual knife-sharpener for worktop
Aigiseur de Couteaux manuel sur table

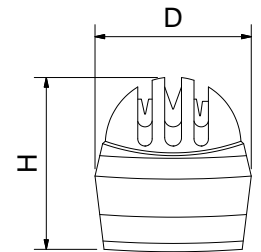

H	D	Gr	Barcode	€
70	65	120	448302	11,00

Afilador de cuchillos manual de sobremesa

Manual knife-sharpener for worktop
Aigiseur de couteau manuel sur table

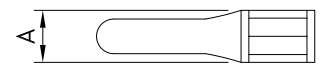
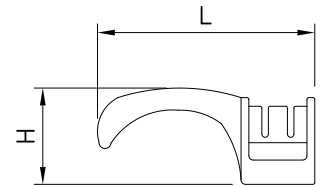

L	A	H	Gr	Barcode	€
210	60	78	200	448310	8,00

Afilador de cuchillos eléctrico mini

Mini electric knife sharpener
Mini affûteur électrique

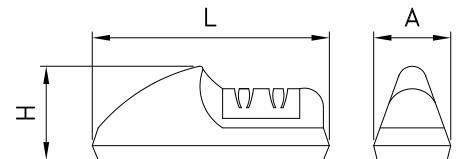

L	A	H	Gr	Barcode	€
190	65	80	340	448314	46,00

Afilador de cuchillos profesional

Professional knife-sharpener
Aigiseur professionnel



Mas información en fricosmos.com
More info in fricosmos.com
Plus d'informations sur fricosmos.com

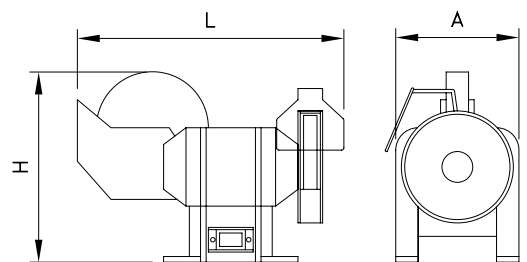

L	A	H	Potencia Power Puissance	Tensión Voltage Tension	Frecuencia Frequency Fréquence	Kg	Barcode	€
415	260	245	270 W	220 V	50 Hz	12	448306	135,00



Repuesto de muela (grano 60) para afilador 448306
Spare grindstone (grit 60) for knife-sharpener 448306
Meule de rechange(grain 60) pour affûteur 448306

D	G	Gr	Barcode	€
150	150	150	448350	54,00

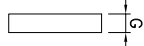

Repuesto de muela abrasiva (grano 120) para afilador 448306
Spare grindstone (grit 120) for knife-sharpener 448306
Meule de rechange(grain 120) pour affûteur 448306

200	40	400	448352	150,00
-----	----	-----	--------	---------------



Portacuchillos Mounted knife Porte-couteaux

Portacuchillos para adosar con envoltente Mounted knife holder with wrapping Porte-couteaux pour adosar avec enveloppant



Cuchillero con alojamiento especial para tijeras y chairas.

Knife-holder with special lodging for scissors and sharpeners.

Porte-couteaux avec logement spécial pour ciseaux et fusils à affûter.

⚠ **Capacidad: 18 cuchillos**
Capacity: 18 Knives
Capacité: 18 couteaux

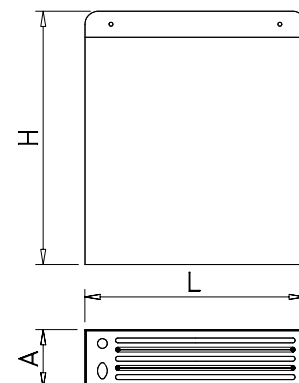

Acoplar portacuchillos
Assembly knife holder
Assembler porte-couteaux

28,00



Este precio no incluye el portacuchillos
Knife-holder not included in this price
Porte-couteaux n'inclus pas dans ce prix

L	A	H	Kg	Barcode	€
380	90	420	3,75	040602	86,00

Portacuchillos portátil Portable knives holder Porte couteaux transportable

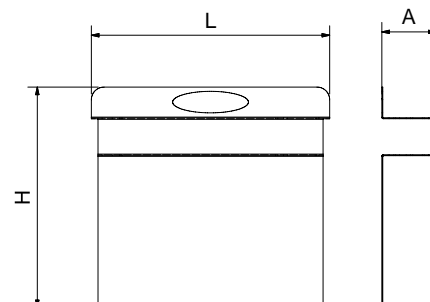

⚠ **Capacidad: 20 cuchillos**
Capacity: 20 Knives
Capacité: 20 couteaux

L	H	A	Kg	Barcode	€
377	350	86	2,40	041050	55,00

Contenedor para transporte de cuchillos

Container for knives transport
Conteneur pour déplacer les couteaux



431518 90,00

Repuesto fibra
Spare fibre
Plaque de rechange

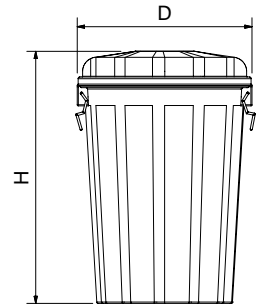
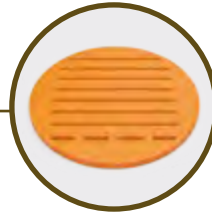

H	D	Kg	Barcode	€
730	495	8,5	041062	112,00

Contenedor para transporte de cuchillos con ruedas

Container for knives transport with wheels
Conteneur pour déplacer les couteaux avec des roues



431516 59,00

Repuesto fibra
Spare fibre
Plaque de rechange

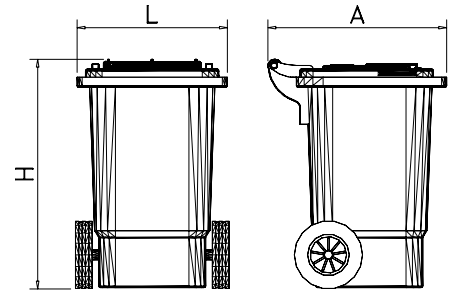

L	A	H	Kg	Barcode	€
470	550	670	11,00	041060	128,00

Portacuchillos con doble alojamiento de sobremesa

Worktop knife holder with dual housing
Porte-couteaux avec deux logements pour placer sur table



Capacidad: 20 cuchillos
Capacity: 20 Knives
Capacité: 20 couteaux

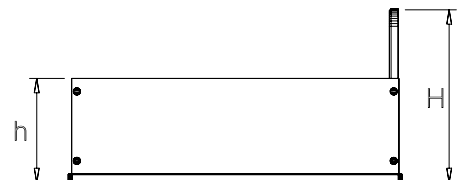

Construido en acero inoxidable y polietileno calidad P-500.
Constructed in stainless steel and P-500 quality polyethylene.
Fait en acier inoxydable et polyéthylène qualité P-500.

L	A	h	H	Kg	Barcode	€
435	165	140	200	3,73	041202	123,00

Portacuchillos para adosar en varilla

Rod mounted knife holders
Porte-couteaux pour adosar sur tringle



Acoplar portacuchillos
Assembly knife holder
Assembler porte-couteaux

€ **28,00**



Este precio no incluye el portacuchillos.
Knife-holder not included in this price.
Porte-couteaux n'inclus pas dans ce prix.

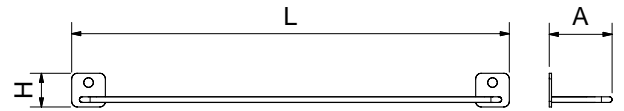

L	H	A	Gr	Barcode	€
340	30	51	270	040802	43,00
390	30	51	300	040804	46,00
440	30	51	330	040806	48,00

Portacuchillos para adosar en chapa

Plated knife holders for mounting
Porte-couteaux plaqué pour adosar



Cuchillero con alojamiento especial para tijeras y chairas.

Knife-holder with special lodging for scissors and sharpeners.

Porte-couteaux avec logement spécial pour ciseaux et fusils à affûter.



Capacidad: 18 cuchillos
Capacity: 18 Knives
Capacité: 18 couteaux

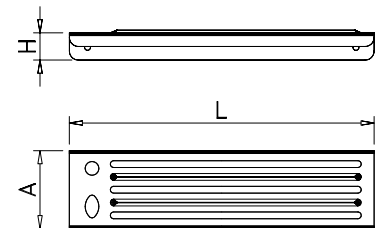

Acoplar portacuchillos
Assembly knife holder
Assembler porte-couteaux

€ **28,00**



Este precio no incluye el portacuchillos
Knife-holder not included in this price
Porte-couteaux n'inclus pas dans ce prix

L	A	H	Gr	Barcode	€
380	90	30	600	041002	24,00
450	90	30	730	041004	28,00

Portacuchillos mural imantado

Magnetic wall knife holder
Porte-couteaux de mur magnétique



L	A	H	Gr	Barcode	€
330	15	46	200	448472	10,00

Portacuchillos mural imantado de acero inoxidable

Magnetic knife-holder in stainless steel
Porte-couteaux magnétique en acier inoxydable

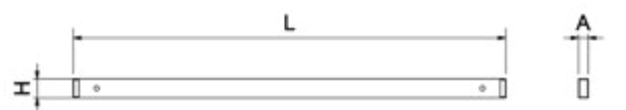

L	H	A	Gr	Barcode	€
456	20	10	500	041602	53,00



Menaje

Kitchenware
Ustensiles de cuisine

Pinza para frituras
Frying tongs
Pince à friture

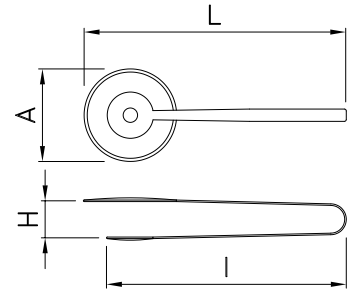

L	I	A	H	Gr	Barcode	€
280	250	100	90	310	440006	5,00

Pinza de servir
Serving tongs
Pincas à servir

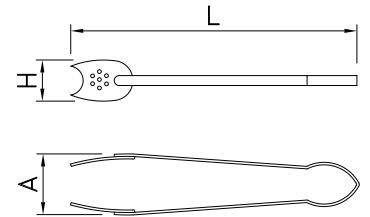

L	A	H	Gr	Barcode	€
230	45	32	200	440002	6,50

Pinza para servir espaguetis acero inox
Stainless steel spaghetti serving tongs
Pince à servir les spaghettis en acier inoxydable

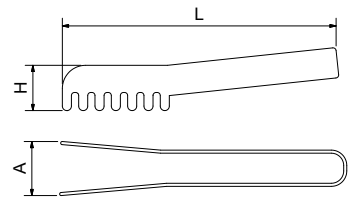

L	A	H	Gr	Barcode	€
190	50	35	60	440094	5,00

Pinza para barbacoa
Barbecue tongs
Pince de barbecue

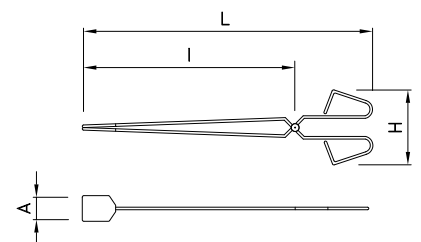

L	I	A	H	Gr	Barcode	€
400	300	45	90	250	440004	6,50

Paleta
Slotted turner
Pelle

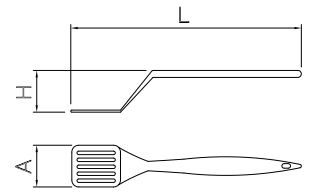

L	A	H	Gr	Barcode	€
330	70	60	170	440038	3,00

Espátulas
Spatula
Spatules



Ver pag. 438
See page 438
Voir page 438

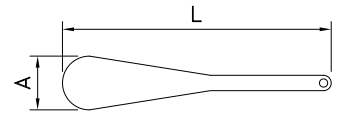

L	A	Gr	Barcode	€
250	50	39	483220	3,50
300	60	65	483222	6,00
350	70	93	483224	5,50

Cazo
Ladle
Louche

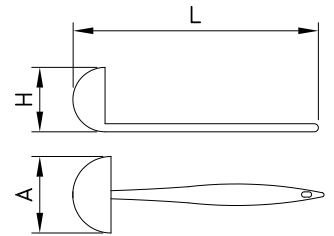

L	A	H	Gr	Barcode	€
305	85	80	200	440032	3,00

Cucharón de servir
Serving spoon
Cuillère à servir

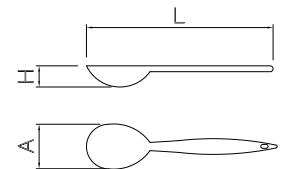

L	A	H	Gr	Barcode	€
340	65	15	150	440034	3,00

Espumadera
Slotted spoon
Écumoire

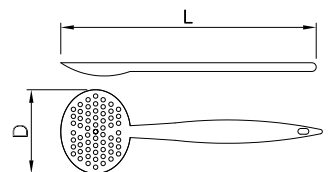

L	D	Gr	Barcode	€
320	100	180	440036	3,00

Espumadera inoxidable con mango de plástico
Stainless steel skimmer with plastic handle
Écumoire en acier inoxydable avec manche en plastique

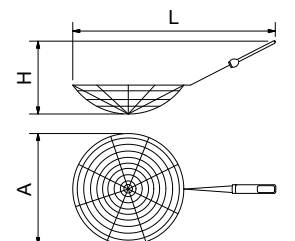

L	D	H	Gr	Barcode	€
350	190	35	180	440037	3,00

Batidor
Whisk
Fouet

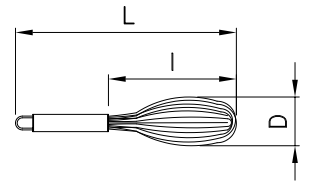
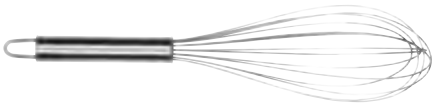

L	I	D	Gr	Barcode	€
300	200	60	180	440014	3,00

Espumador eléctrico manual mini con soporte
Mini electric frother with stand
Mini mousser électrique manuel avec support



Novedad
NEW
NOUVEAU

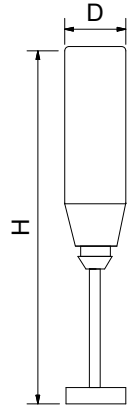

D	H	Gr	Barcode	€
35	224	120	480246	15,00

Mortero de acero inox
Stainless steel mortar
Mortier en acier inoxydable

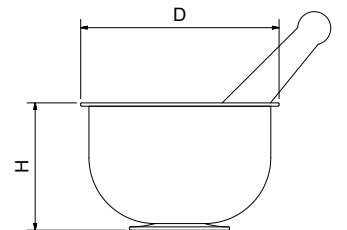

D	H	Gr	Barcode	€
120	80	300	440096	29,00

Colador
Colander
Passoir

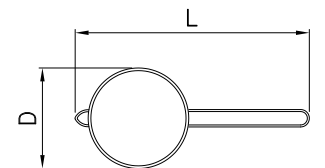

L	D	Gr	Barcode	€
375	185	180	440011	8,00

Colador/Tamizador
Colander/Chinese strainer
Passoire/Chinois étamine inox

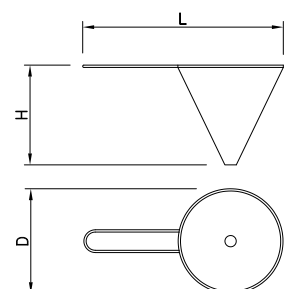

L	D	H	Gr	Barcode	€
350	180	130	400	440010	8,00

Mazo para chino

Tool for strainer
Outil pour chinois étamine

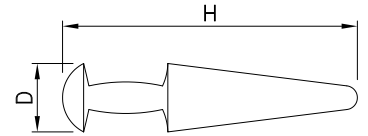

D	H	Gr	Barcode	€
65	280	400	434460	55,00

Escurreidor de verduras

Vegetable drainer
Egouttoir légumes

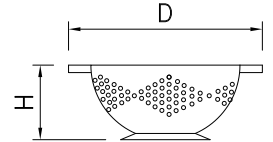

D	H	Gr	Barcode	€
305	100	250	440060	10,50

Escurreidor de ollas regulable

Multi-colander
Passoire multiple



Características:
Acoplable a varios diámetros.

Characteristics:
Coupled with various diameter.

Caractéristiques:
Adaptables à différents diamètre.

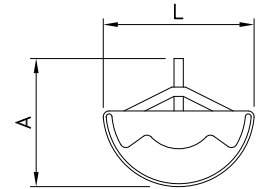

L	A	Gr	Barcode	€
230	220	110	440072	9,50

Volteadora inox de tortilla

Stainless steel turner lid for omelettes
Couvercle retourne-omelette inox

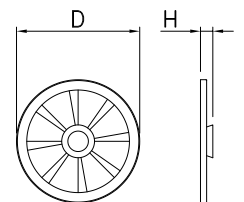

D	H	Gr	Barcode	€
300	15	250	440910	9,00

Librador

Scoop
Cornet

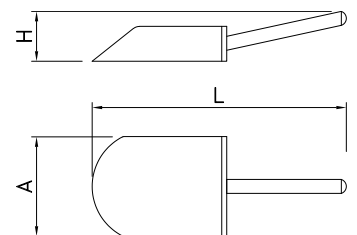

L	A	H	l	h	Gr	Barcode	€
235	75	85	120	30	150	440074	10,00
280	100	90	160	40	170	440076	12,00
300	135	110	200	60	200	440078	15,00





AD

Utensilios de cocina

Cooking utensils
Ustensiles de cuisine

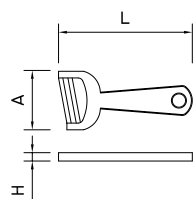
Pelador de cerámica
Ceramic peeler
Couteau éplucheur en céramique



	L	A	H	Gr	Barcode	€
	120	50	20	75	446122	4,50
	140	80	30	27,2	446124	6,50

Abrelatas tenaza
Can opener
Ouvre-boite

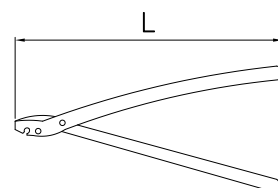

L	Gr	Barcode	€
150	125	440020	5,00

Abrelatas
Can opener
Ouvre-boîtes

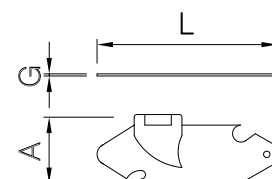

L	A	G	Gr	Barcode	€
80	30	2	50	440019	2,00

Abrelatas industrial

Industrial can opener
Ouvre-boîtes industriel

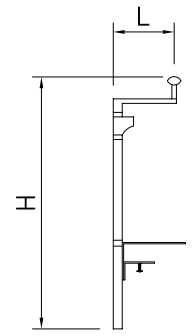

L	H	Kg	Barcode	€
150	550	1,80	440021	116,00



Repuesto roldana para abrelatas industrial 440021

Spare cog for commercial can opener 440021

Pièce de rechange, engrenage pour ouvre-boîte industriel 440021

Gr	Barcode	€
35	440090	21,00

Repuesto cuchilla para abrelatas industrial 440021

Spare blade for commercial can opener 440021

Pièce de rechange, lame pour ouvre-boîte industriel 440021

Gr	Barcode	€
7	440092	20,00

Conjunto de 3 aros de emplatar en acero inox

Rings mold set in stainless steel - 3 pieces
Set de 3 moules à dresser en acier inox

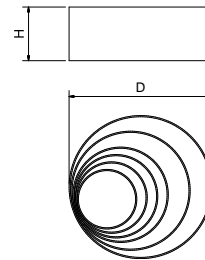

D	H	Gr	Barcode	€
60				
80	45	160	440064	5,00
100				

Conjunto aros de emplatar

Ring mold set
Set de moules

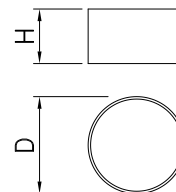
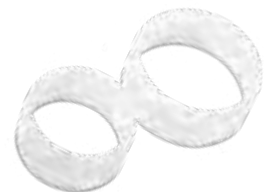

D	H	Gr	Barcode	€
60	45	150		
80	45	150	434472	13,00

Moldes cuadrados

Square pastry mould
Cercle carre pour pâtisserie

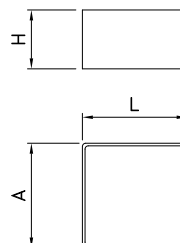

L	A	H	Gr	Barcode	€
60	60	45	60	440080	3,50
70	70	45	70	440082	3,60
80	80	45	90	440084	3,70
90	90	45	100	440086	3,80
100	100	45	110	440088	3,90

Set de 4 flaneras de ø8 cm

4 flan mould set ø8 cm
Lot de 4 moules à flan ø8 cm

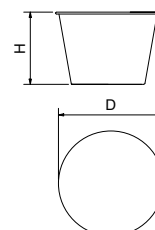

D	H	Gr	Barcode	€
80	55	120	440328	4,00



Enrollador de maki super-higiénico
Sushi rolling mat, ultra-hygienic
Enrouleur de maki super-hygiénique

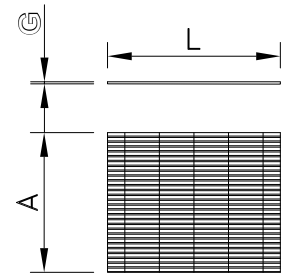

L	A	G	Gr	Barcode	€
250	165	3	110	434486	30,00
250	240	3	160	434488	35,00
250	305	3	200	434490	45,00

Especiero inox con tres niveles
Spice rack three levels
Armoire à épices

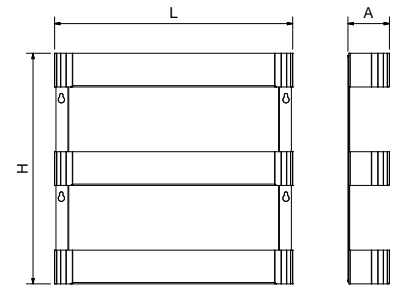

L	A	H	Kg	Barcode	€
353	61	342	1,4	040204	56,00

Estante especiero
Spices and oils rack
Étagère pour épices

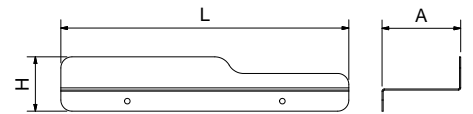

L	A	H	Gr	Barcode	€
260	71	49	231	040206	16,00

Escurreidor mural para utensilios de cocina
Wall drainer for kitchen utensils
Egouttoir mural pour ustensiles de cuisine



L	A	H	Kg	Barcode	€
400	365	100	2,4	042602	50,00

Escurreidor de platos y vasos en acero inoxidable
 Stainless steel drainer for glasses and dishes
 Egouttoir en acier inoxydable pour assiettes et verres



Novedad
 new
 arrival

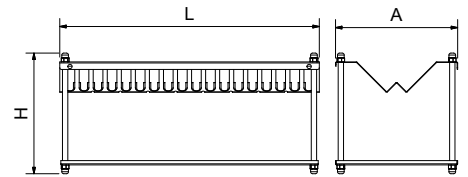

L	A	H				€
484	228	225	18	1,78	051602	48,00
955	228	225	36	3,25	051604	75,00

Molinillo de hierbas
 Herb mill
 Moulin à herbes

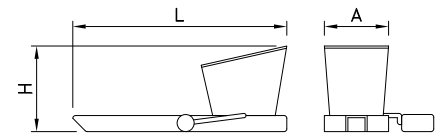

L	A	H			€
200	60	80	110	440902	10,50

Rallador de queso
 Cheese grater
 Râpe à fromage

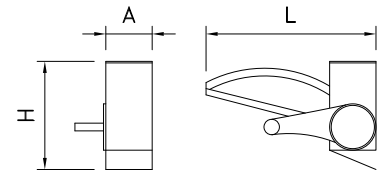

L	A	H			€
230	100	80	1,37	447914	12,00

Prensa ajos
 Garlic press
 Presse-ail

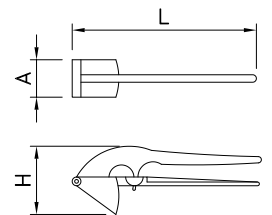

L	A	H			€
200	22	90	270	440042	7,00

Molinillo 2 en 1 sal y pimienta
 Two-in-one salt and pepper grinder
 Moulin à sel et poivre 2 en 1



Novedad
 new
 arrival

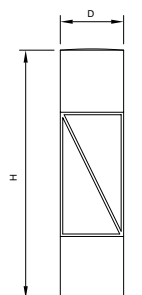

D	H			€
51	200	300	440046	20,00

Rallador inox
Stainless steel grater
Râpes inox

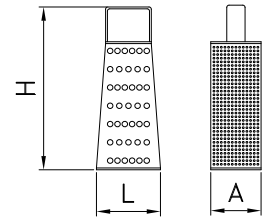

L	A	H	Gr	Barcode	€
90	60	170	100	447916	5,00

Molinillo juliana
Julienne mill
Moulin julienne

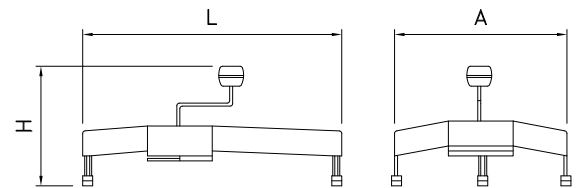

Incluye 5 discos
5 discs included
5 disques inclus

L	A	H	Gr	Barcode	€
180	260	60	800	440904	27,50

Pasapuré profesional
Professional food mill
Presse-purée professionnel

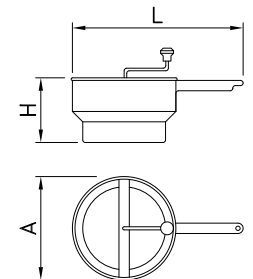

Incluye 3 discos
3 discs included
3 disques inclus

L	A	H	Gr	Barcode	€
400	240	90	570	440906	15,00

Picador de tomate
Tomato squeezer
Presse tomates

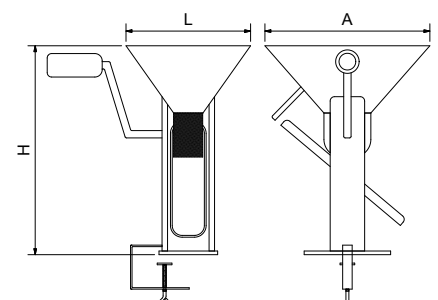

L	A	H	Kg	Barcode	€
170	225	300	1,38	447904	44,00

Mandolina para cortar / laminar trufas en acero inoxidable

Truffle slicer in stainless Steel

Mandoline en acier inoxydable pour couper - laminer des truffes



Novedad
NEW
DESIGN

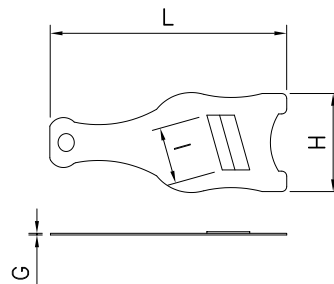

L	I	H	G	Gr	Barcode	€
200	60	85	1,2	115	440918	32,00

Triturador de hielo

Ice crusher

Broyeur à glace

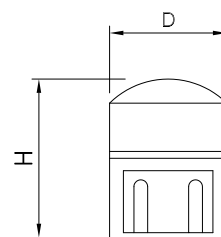

D	H	Gr	Barcode	€
150	260	700	447902	29,50

Cortadora de fiambres manual

Cold meat cutter

Trancheuse de charcuterie



Características:

Construida en acero inoxidable.

Diámetro del disco-cuchilla \varnothing 120mm

Desplazamiento de carro progresivo con un mango tipo ruleta que regula la anchura de corte.

Characteristics:

Made of stainless steel

Blade disc diameter \varnothing 120mm

Progressive cutting carriage displacement, by a spinning handle for cutting adjustment

Caractéristiques:

Fabriquée en acier inoxydable.

Diamètre de la lame disque \varnothing 120mm

Déplacement progressif du chariot avec une poignée roulette qui règle la largeur de coupe.

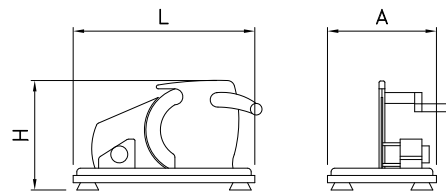

L	A	H	Kg	Barcode	€
250	145	160	1,00	447906	81,50

Punzonador de embutidos

Sausage punch

Outil perce-saucisse

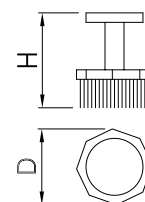

D	H	Gr	Barcode	€
40	50	50	440028	12,50

Embudo
Funnel
Entonnoir

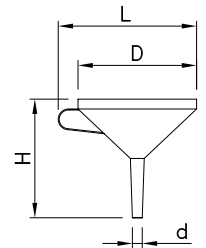

L	D	H	d	Gr	Barcode	€
170	140	135	17	150	440012	10,50

Biberones de cocina
A squeeze bottle
Biberons de cuisine

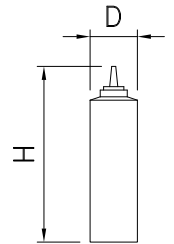

D	H	ml	Gr	Barcode	€
50	190	250 ml	33	440912	2,00
60	230	500 ml	50	440913	2,50

Dispensador de salsa con dosificador
Sauce dispenser with pump
Distributeur de sauce avec doseur

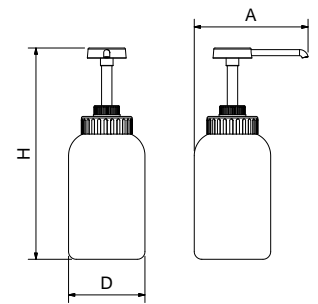

A	H	D	Color	Barcode	€
151	275	99	Red	487298	23,00
			Yellow	487299	

Conjunto dispensador de 3 salsas con dosificadores y soporte
3 sauces dispenser set with stand support
Ensemble de 3 distributeurs de sauces avec doseurs et support

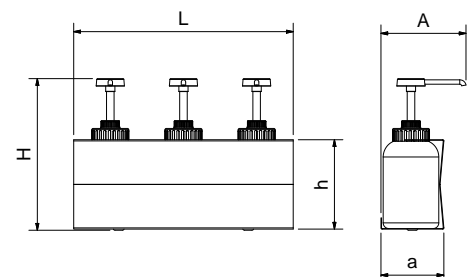

L	A	H	a	h	Kg	Barcode	€
390	155	276	112	159	1,40	040242	143,00

Soporte organizador de acero inoxidable para 3 salsas

Stainless steel organizer rack for 3 sauce bottles

Support organisateur en acier inoxydable pour 3 sauces

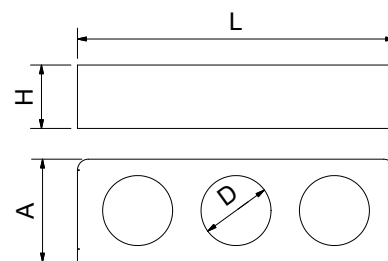

L	A	H	D	Gr	Barcode	€
290	94	58	64	400	040244	14,00

Dosificador de salsas y recipiente inox

Container and pump-dispenser for sauce

Distributeur-doseur de sauces et récipient inoxydable



Bomba de 5 cc.
Cierre a presión.
Contenedor inox con tapa plástica transparente.

Colored pumps 5 cc.
Snap closing.
Inox container with transparent plastic lid.

Pompe de 5 cc.
Fermeture à pression.
Récipient inox avec couvercle en plastique transparent.

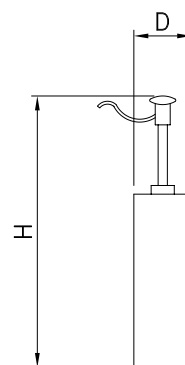

D	A	H	Gr	Barcode	€
				487283	
80	110	220	0,5 lts	400	487292 76,00
				487294	

Pala inoxidable para patatas fritas con dos asas

Stainless steel shovel with two handles, for french fries

Pelle en acier inoxydable à frites, à double poignée

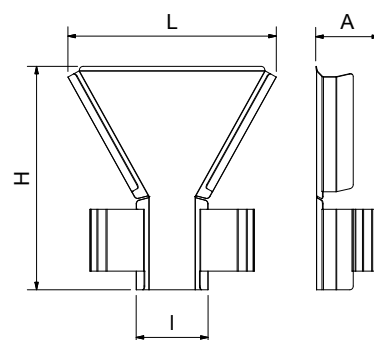

L	I	A	H	Gr	Barcode	€
224	77	69	240	400	040218	18,00

Dosificador de salsas - 30 ml.

Sauces dispenser - 30 ml.
Distributeur de sauces - 30 ml.



Concepto Concept Concept		€
Taladro Drill hole Tariere	082808	4,00

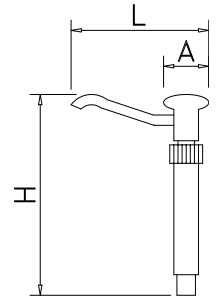

L	A	H			€
130	40	270	50	487278	20,00

Balanza mecánica de cocina

Kitchen scales
Balance mécanique de cuisine



Características:
Capacidad: 5 Kg.
Divisiones de 20 en 20 gramos.
Sensibilidad: 20 gramos.

Characteristics:
Capacity: 5 kg.
Divisions every 20 gr.
Accuracy: 20 gr.

Caractéristiques:
Capacité : 5 Kg.
Divisions de 20 en 20 grammes.
Sensibilité : 20 grammes.

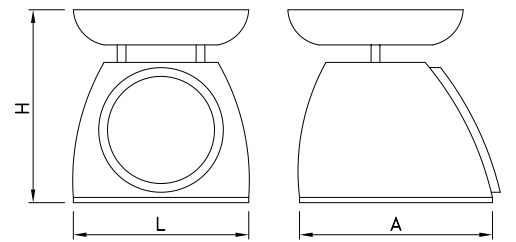

L	A	H			€
220	200	220	1,80	480234	58,00

Balanza de cocina digital 5 kg

Digital kitchen scale 5 kg
Balance de cuisine numérique 5 kg



Características:
Capacidad máxima 5kg
Sensibilidad 1gr
Unidades de medida: gr, oz, lb, ml
Indicador de pila baja y sobrecarga
Función de tara
Auto-apagado

Caractéristiques:
Capacité 5kg
Sensibilité 1gr
Unités de mesure: gr, lb, oz, ml
Indicateur de pile basse et de surcharge
Fonction de tare
Arrêt automatique

Characteristics:
Max. Capacity 5kg
Accuracy 1gr
Units of measurement: gr, lb, oz, ml
Low battery and overload indicators
Tare function
Auto power-off

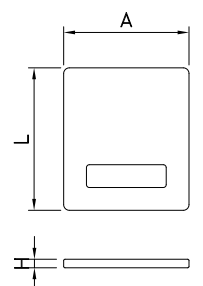

L	A	H			€
180	140	18	500	480232	24,00

Balanza de cocina de precisión 0,1 g

Precision kitchen scale 0.1 g
Balance de cuisine de précision 0,1 g



Características:
Capacidad: 1 Kg.
Sensibilidad: 0,1 grs.
Función tara.
Unidades de medida: gr, oz.

Characteristics:
Capacity: 1 kg.
Accuracy: 0,1 grs.
Tare function.
Units of measurement: gr, oz.

Caractéristiques:
Capacité: 1 Kg.
Sensibilité : 0,1 grs.
Fonction de taré
Unités de mesure: gr, oz.

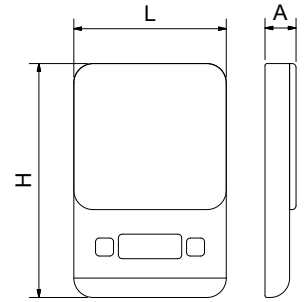

L	A	H	Gr	Barcode	€
113	24	181	230	480233	40,00

Rasqueta para vitrocerámicas

Scraper for glass ceramic
Grattoir pour vitrocéramique

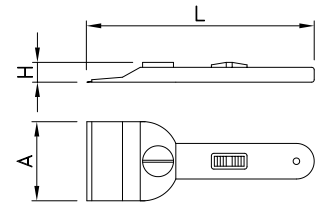

L	A	H	Gr	Barcode	€
135	45	18	100	448110	4,00

Espátula para planchas de cromo-duro

Spatula for chromium plate griddles
Raclor pour plaques chromées

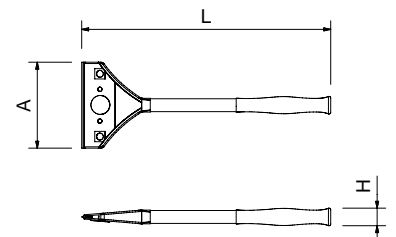

L	A	H	Gr	Barcode	€
290	100	20	348	448102	39,00



Hojas de repuesto en acero inoxidable para espátula plancha de cromoduro.

Stainless steel spare blades for chromium plate griddle spatula.
Lames de rechange pour raclor à plaque chromée.



10 50 448104 **25,00**



AD

Utensilios para pizzería

Pizza making utensils
Ustensiles pour pizzeria

Picador de masa de pizza en acero inox

Pizza dough pitter in stainless steel
Pique pâte à pizza en acier inox

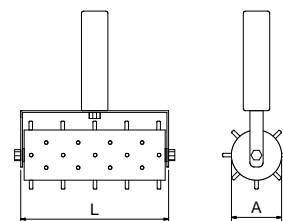

L	A	Gr	Barcode	€
127	44	350	440706	47,00

Pinza para bandeja de horno en acero inox

Clip for baking tray in stainless steel
Pincas pour plaque à four en acier inox



L	A	Gr	Barcode	€
190	30	100	440714	10,50

Cazo para salsa en acero inox

Saucepan in stainless steel
Cuillère à sauce en acier inox

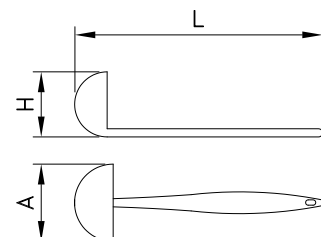

L	A	H	Gr	Barcode	€
370	90	90	170	440712	16,50

Rasqueta cortadora de masa en acero inoxidable
 Stainless steel dough cutter/scrapper
 Racloir à pâte en acier inoxydable

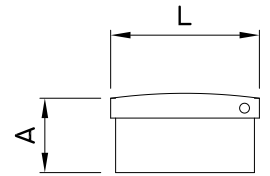

L	A	Gr	Barcode	€
150	75	180	440748	14,00

Cortadora de masa de pizza
 Pizza dough cutter
 Coupe pâte à pizza

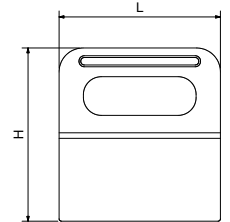

L	H	Gr	Barcode	€
135	145	100	440722	16,50

Rejilla de aluminio para hornear pizza
 Aluminum baking rack for pizza
 Grille à pizza en aluminium

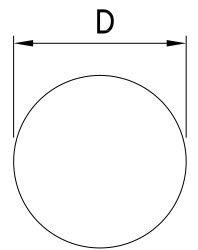

D	Gr	Barcode	€
370	150	440750	18,00

Bandeja de aluminio con asas para pizza 6 porciones
 Pizza aluminium tray with handgrips - 6 slices
 Plaque en aluminium avec poignées pour pizza 6 portions

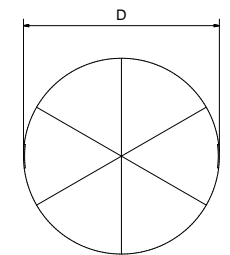

D	Gr	Barcode	€
450	300	440708	50,00

Bandeja de aluminio con mango para pizza 6 porciones
 Pizza aluminium tray with handle - 6 slices
 Plaque en aluminium avec manche pour pizza 6 portions

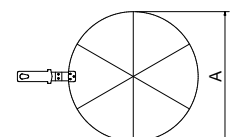
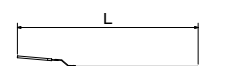

L	A	Gr	Barcode	€
660	450	320	440710	70,00

Pala redonda de aluminio para horno
 Rounded tray baking peel in aluminium
 Pelle ronde en aluminium pour four

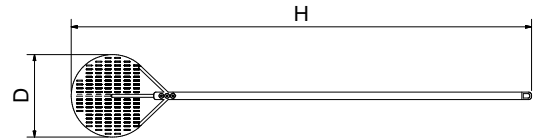

D	H	Gr	Barcode	€
330	1860	880	440702	120,00

Pala para pizza
 Pizza oven peel
 Pelle à pizza



Novedad
 ew
 navesar

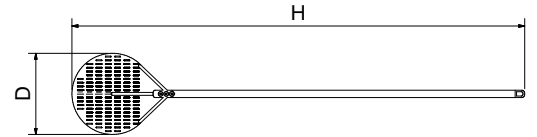

D	H	Gr	Barcode	€
220	1.740	770	440746	97,50

Pala cuadrada de aluminio para horno
 Squared tray baking peel in aluminium
 Pelle carrée en aluminium pour four

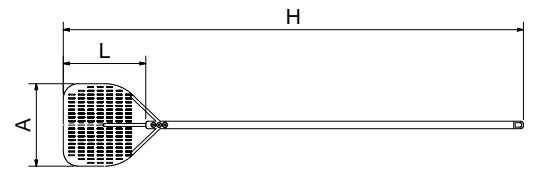

L	A	H	Gr	Barcode	€
330	330	1860	900	440704	120,00

Paleta oval en acero inox
 Oval serving spatula in stainless steel
 Pelle ovale en acier inox



Resistencia hasta 200° C
 Heat resistance up to 200° C
 Résistance jusqu'à 200° C

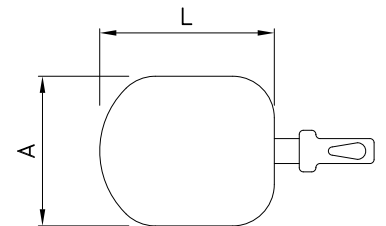

L	A	Gr	Barcode	€
210	180	500	440728	40,00

Paleta oval en acero inox perforada
 Oval perforated serving spatula in stainless steel
 Pelle ovale perforé en acier inox



Resistencia hasta 200° C
 Heat resistance up to 200° C
 Résistance jusqu'à 200° C

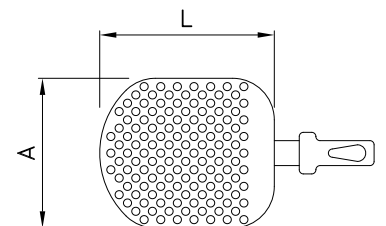

L	A	Gr	Barcode	€
220	180	500	440730	47,00

Paleta redonda aluminio
 Rounded tray baking peel in aluminium
 Pelle ronde en aluminium pour four



Resistencia hasta 200° C
 Heat resistance up to 200° C
 Résistance jusqu'à 200° C

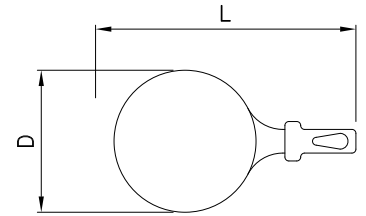

L	D	Gr	Barcode	€
430	280	350	440732	42,00

Cortador de pizza
 Pizza cutter
 Couteau à pizza

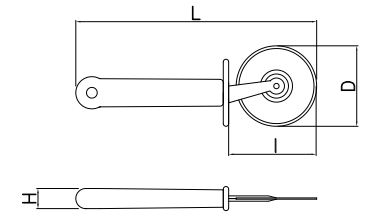

L	H	I	D	Gr	Barcode	€
190	20	70	65	66	446908	3,00

Cortador de pizza profesional
 Professional pizza cutter
 Coupe pizza professionnel

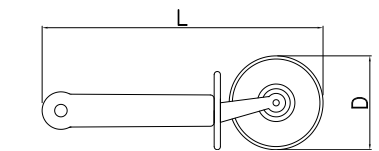

L	D	Gr	Barcode	€
245	100	150	440716	9,50

Paleta para servir pizza en acero inox
 Pizza server in stainless steel
 Pelle pour servir pizza en acier inox

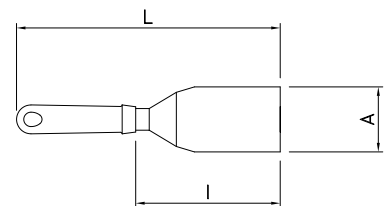

L	A	I	Gr	Barcode	€
250	70	100	140	440718	12,50

Bolsa térmica para transporte de pizza
 Insulated thermal pizza delivery bag
 Sac thermique pour transporter des pizzas

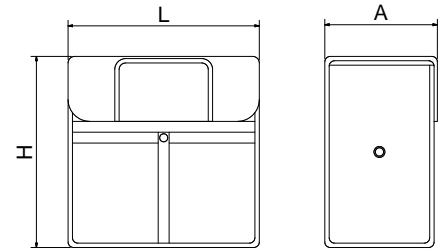

L	A	H	Gr	Barcode	€
440	290	450	4	700	440726 88,00

Bases inoxidables para transporte de pizzas
 Stainless pizza pans
 Base inox pour transport de pizzas

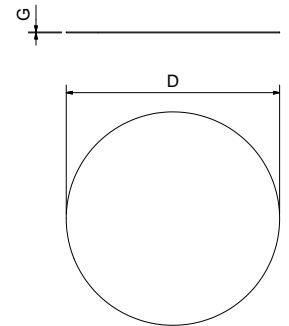

D	G	Kg	Barcode	€
278	1	0,49	042402	11,00
406	1	1,04	042404	16,00

Cepillo de limpieza con mango orientable para hornos profesionales
 Cleaning brush with adjustable handle for professional ovens
 Brosse de nettoyage avec manche réglable pour fours professionnels



440754 € 25,00

Repuesto de cepillo de limpieza.
 Replacement cleaning brush.
 Brosse de nettoyage de rechange.

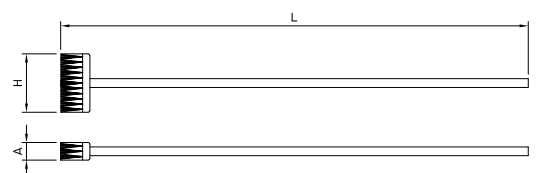
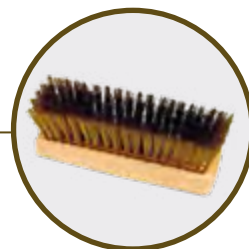

L	A	H	Gr	Barcode	€
1.740	60	200	800	440752	107,50



AD

Utensilios para pasteleros

Pastry making utensils
Ustensiles pour pâtisseries

Laminador de tartas
Cake slicer
Laminair pour tartes

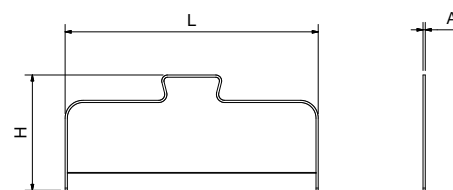

L	A	H	Gr	Barcode	€
360	12	130	170	440304	4,00

Molde para laminar tartas 24/30 cms.
Layer cake slicer for cakes 24/30 cms.
Moule à laminer tarte 24/30 cms.

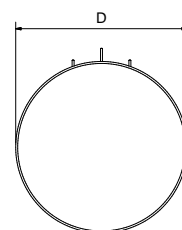

D	H	Gr	Barcode	€
250	100	720	440306	13,00

Pincel de silicona y acero inox
Pastry brush in silicone and stainless steel
Pinceaux en silicone et acier inox

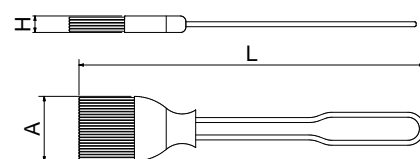

L	A	H	Gr	Barcode	€
200	50	10	48	440312	4,00

Espátula de silicona y acero inox
Spatula in silicone and stainless steel
Spatule en silicone et acier inox

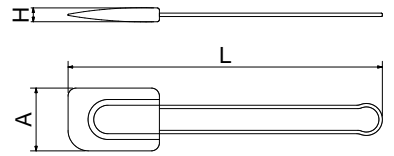

L	A	H	Gr	Barcode	€
280	58	12	89	440310	5,00

Espátula pastelera
Bakery spatula
Spatule à gâteau

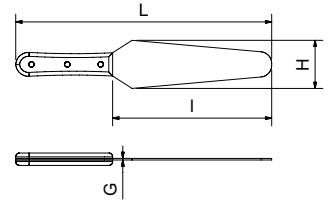

L	I	H	G	Gr	Barcode	€
215	125	26	1,0	65	441402	10,00
255	155	26	1,0	70	441404	12,00
335	205	40	1,0	170	441406	20,00
385	255	45	1,0	190	441408	20,50
440	315	45	1,5	205	441410	30,00
490	365	45	1,5	265	441412	31,00

Conjunto de conos para relleno de crema en acero inox
Stuffing horn set in stainless steel
Set de moules cornets pour garniture de crème en acier inox

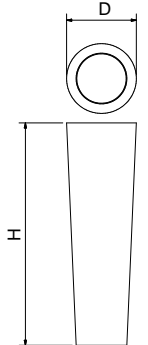

H	D	Gr	Barcode	€
65	16	5	122	440302 6,50
135	22	2		

Pala inox para servir tarta
Stainless steel cake serving shovel
Pelle à tarte en acier inoxydable

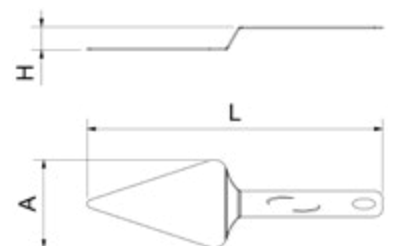

L	A	H	Gr	Barcode	€
285	85	22	130	040222	8,00

Pala para tartas / pizza en acero inox
 Cake / pizza server in stainless steel
 Pelle à tarte / pizza en acier inox

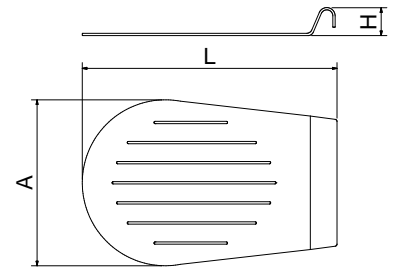

L	A	H	Gr	Barcode	€
430	290	20	356	440314	20,00

Tamizador en acero inox
 Sifter in stainless steel
 Tamis en acier inox

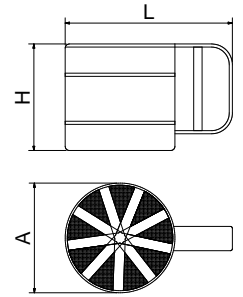

L	A	H	Gr	Barcode	€
160	105	102	195	440316	18,00

Jarra medidora con fondo antideslizante 1 L
 Measuring jug 1 liter with non-slip bottom
 Verre doseur avec fond antidérapant 1 litre

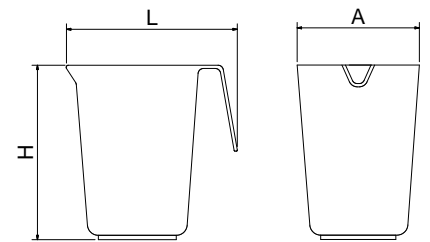

L	A	H	Gr	Barcode	€
112	145	160	160	440308	12,00

Jarra medidora de cristal 1 L.
 Glass jug 1 L
 Pichet doseur 1 L

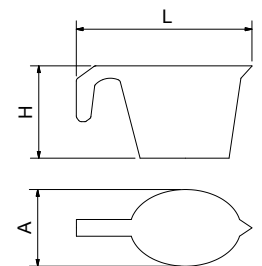

L	A	H	Gr	Barcode	€
210	150	110	160	440324	12,50

Máquina para hacer churros y pastas
 Churros and cookies machine
 Appareil à churros et pâtisserie



Barcode €
 447910 7,00

Discos de respuesto para máquina de hacer churros y pastas
 Spare discs for pastry and churros maker
 Disques de rechange pour machine à churros et pâtes

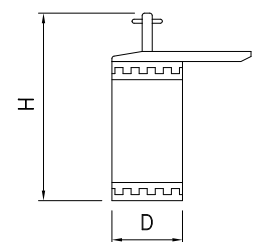

D	H	Gr	Barcode	€
70	150	530	447908	36,00



AD

Servicio de mesa y barra
 Table and bar service
 Service de table et comptoir

Porta brochetas
 Skewer holder
 Porte-brochettes

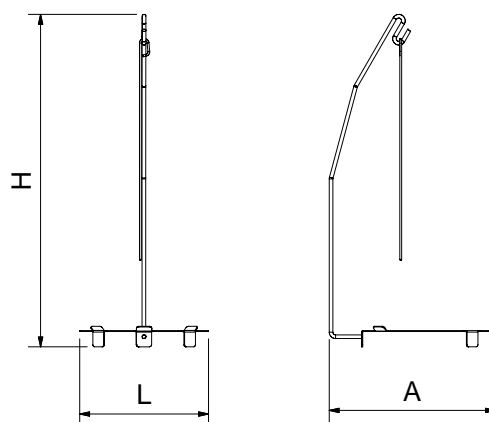

L	A	H	Kg	Barcode	€
210	270	540	1,00	040230	41,00

Pinchos brocheta
 Kebab sticks
 Brochettes

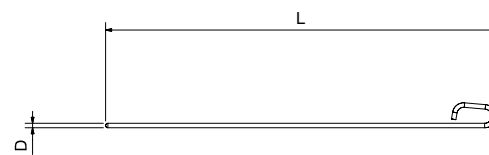

L	D	Gr	Bolsa Bag Sac	Barcode	€
261	3	15	10	040208	2,00
311	3	20	10	040210	2,00
361	3	25	10	040212	2,00

Precio y peso por unidad.
 Unit price and weight.
 Prix et poids unitaire.

Cuencos

Bowls
Bols

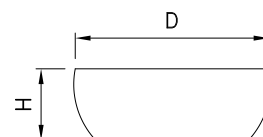

D	H	Gr	Barcode	€
140	50	0,6	99 483210	3,00
190	70	1,5	155 483212	5,00
240	90	3,0	267 483214	7,00

Cuencos para salsas

Sauce bowl
Bol à sauce

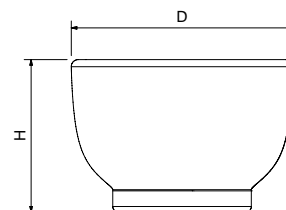

D	H	Color	Gr	Barcode	€
98	50	Red	300	434424	9,00
98	50	White	300	434426	9,00
98	50	Yellow	300	434428	9,00
98	50	Green	300	434430	9,00

Bowls en policarbonato transparente

Bowls in transparent polycarbonate
Bols en polycarbonate transparent

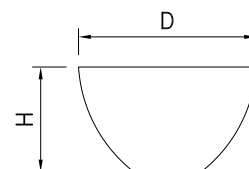

D	H	Gr	Barcode	€
120	74	115	483202	4,50
217	128	200	483204	9,50
282	174	290	483206	18,00

Bowl de acero inoxidable

Stainless steel mixer bowl
Bol mélangeur en acier inoxydable

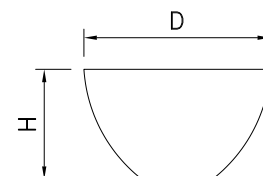

D	H	Kg	Barcode	€
130	260	0,59	480614	44,00
150	300	0,77	480616	13,00
160	360	0,86	480618	55,00



Fibras chuletón rectangulares
 Rectangular fibre steak-boards
 Fibras côtes de bœuf rectangulaires

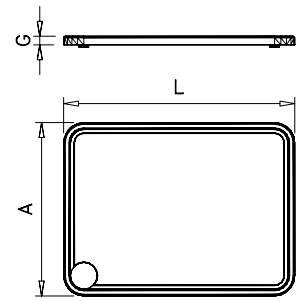

L	A	G	Kg	Barcode	€
400	200	20	1,6	432310	14,00

Plato de presentación
 Presentation plate
 Assiette de présentation

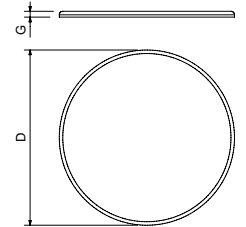

D	G	Gr	Barcode	€
300	10	900	434436	18,00

Plato de presentación especial pulpo
 Octopus presentation plate
 Assiette de présentation poulpe

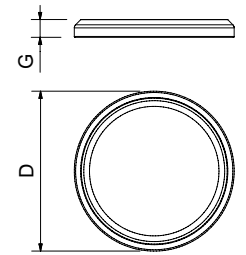

D	G	Gr	Barcode	€
180	20	648	434434	14,00

Plato pizza
 Pizza plate
 Assiette de pizza

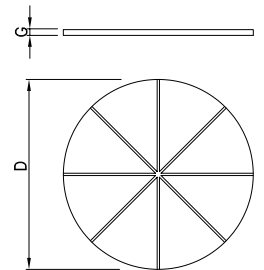

D	G	Kg	Barcode	€
300	10	1,0	434438	19,00

Conjunto rompe marisco
 Cracker hammer seafood set
 Set à fruits de mer

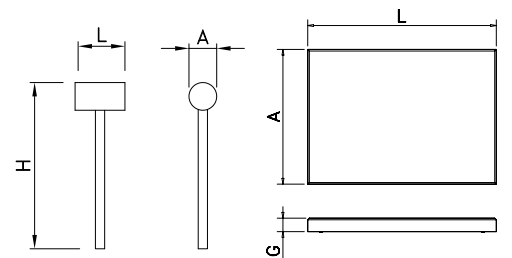

L	A	G	H	Gr	Barcode	€
100	100	15		200	434466	9,00
70	30		180			

Plato de cocktail
Cocktail plate
Assiette de cocktail

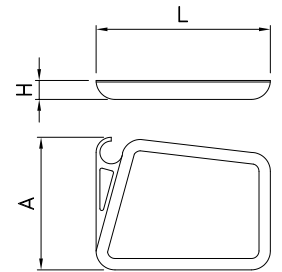

L	A	H	Gr	Barcode	€
230	175	20	80	480650	3,00

Soporte inox para tacos o burritos
Stainless steel holder for tacos or burritos
Support en acier inoxydable pour tacos ou burritos



Novedad
est.
nouveauté

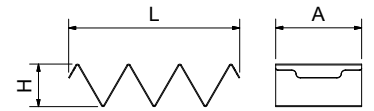

L	A	H	Gr	Barcode	€
193	97	48	300	040224	9,00

Plato cuatro salsas
French fries dish 4 sauces
Plat a frites 4 sauces

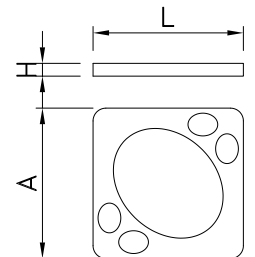

L	A	H	Gr	Barcode	€
235	235	20	199	480654	7,50

Salsera circular 6 salsas
Round polyethylene serving board for 6 sauces
Planché polyéthylène ronde à 6 sauces

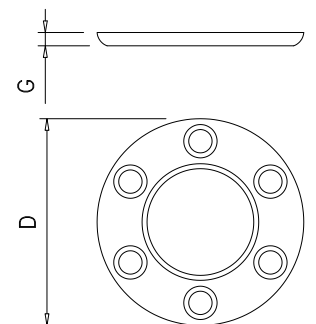

D	G	Gr	Barcode	€
330	20	500	434420 434422	42,00

Salsera 8 salsas

Oval polyethylene serving board for 8 sauces
Planche polyéthylène ovale à 8 sauces

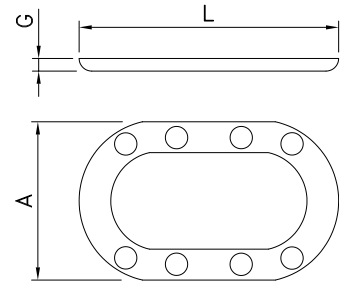

L	A	G	Kg	Barcode	€
410	250	20	1,70	434414	49,00

Salsera rectangular 4 salsas

Rectangular polyethylene serving board for 4 sauces
Planche polyéthylène rectangulaire à 4 sauces

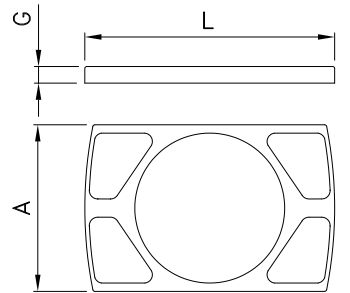

L	A	G	Kg	Barcode	€
300	200	20	1,00	434416	29,00

Salsera rectangular 6 salsas

Rectangular polyethylene serving board for 6 sauces
Planche polyéthylène rectangulaire à 6 sauces

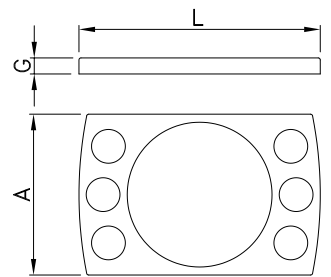

L	A	G	Kg	Barcode	€
300	200	20	1,00	434418	29,00

Salseras de diseño 6 salsas

Serving boards design for 6 sauces
Planche en polyéthylène à 6 sauces modèle design

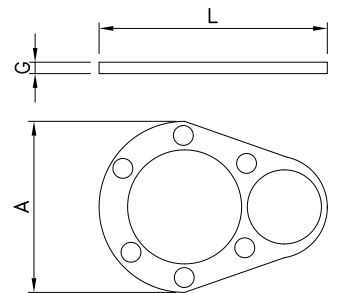

L	A	G	Kg	Barcode	€
440	300	20	2,20	434412	49,00

Plato giratorio de cristal

Rotating glass plate
Assiette en verre tournante

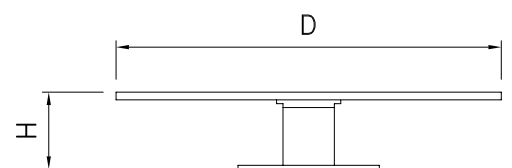

D	H	Gr	Barcode	€
300	60	500	480656	24,00

Plato giratorio
Rotating plate
Assiette tournante

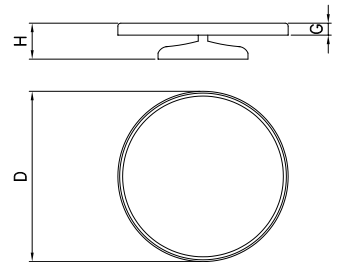

D	G	Kg	Barcode	€
285	20	1,30	434437	45,00

Bandeja de frío GN cold plate
Cold plate GN
Plaque froid GN cold plate



Características:
Se guarda en el congelador un mínimo de 4h. Mantiene el frío durante bastante tiempo, lo que permite una presentación higiénica de los alimentos.

Characteristics:
It must be kept in the freezer for 4 hours. It keeps cold for quite long time, for a hygienical presentation of food.

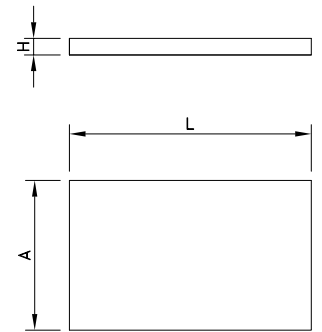

Caractéristiques:
Il faut le mettre au congélateur un minimum de 4 heures. Maintient au froid durant assez longtemps, ce qui permet une présentation hygiénique des aliments.

L	A	H	Kg	Barcode	€
525	325	40	3,7	476094	66,00

Barbacoa portátil profesional de sobremesa y acero inoxidable
Professional portable tabletop barbecue of stainless steel
Barbecue de table portable professionnel et acier inoxydable

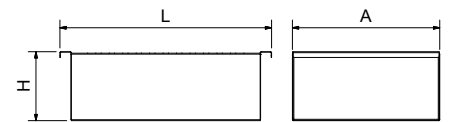

L	A	H	Kg	Barcode	€
408	284	133	4,0	043002	99,00

Cesta rectangular
Rectangular wire basket
Panier rectangulaire

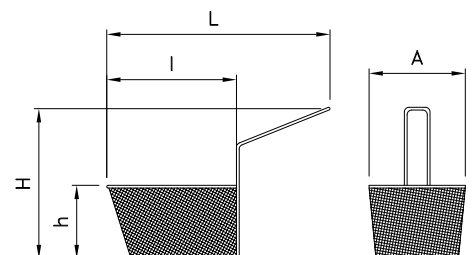

L	A	H	I	h	Gr	Barcode	€
240	105	165	140	80	160	480602	6,00

Cesta redonda
Round wire basket
Panier Rond

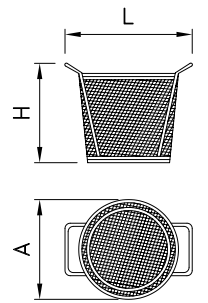

L	A	H	Gr	Barcode	€
120	95	90	125	480604	6,00

Vaso en policarbonato
Polycarbonate glass
Verre polycarbonate

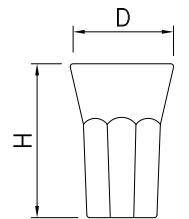

D	H	cl	Gr	Barcode	€
80	88	27 cl.	60	483260	3,00
90	106	40 cl.	80	483262	3,00
90	132	50 cl.	105	483264	3,50

Copa en policarbonato
Polycarbonate cup
Tasse polycarbonate

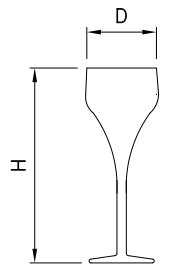

D	H	cl	Gr	Barcode	€
74	207	18 cl.	85	483250	4,50

Jarra de agua
Water jug
Pichet

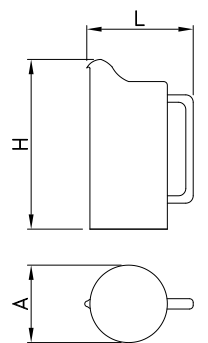

L	D	H	l	Gr	Barcode	€
230	120	170	1,5	80	483254	9,00

Tenedor de mesa
Table fork
Fourchette de table

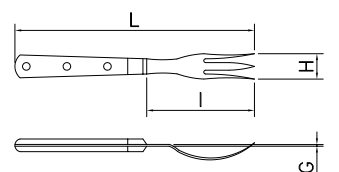

L	I	H	G	Gr	Barcode	€
190	86	23,4	1,44	53	440126	9,50

Cuchara de mesa

Table spoon
Cuillère à soupe

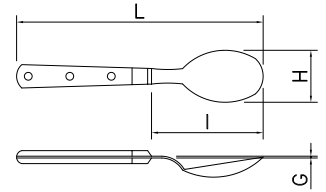

L	I	H	G	Gr	Barcode	€
192	87,10	41,04	1,33	72	440128	14,00

Cuchillo de mesa modelo chuletero

Steak table knife
Couteau de table modèle pour côtelette

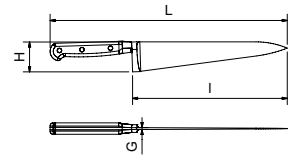

L	I	H	G	Tipo Type	Gr	Barcode	€
225	114	21	1,80	STD †	93	440120	8,00

Cuchillo de mesa corte liso

Table knife, smooth cut blade
Couteau de table bord lisse

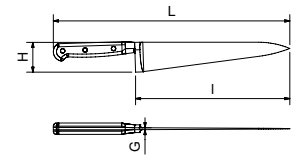

L	I	H	G	Tipo Type	Gr	Barcode	€
216	112	20	1,36	STD †	62	440124	9,50

Cuchillo de mesa modelo chuletón

Ribeye steak table knife
Couteau de table modèle pour steack

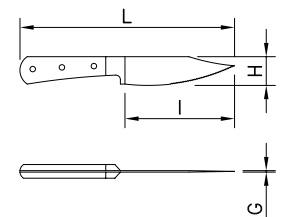

L	I	H	G	Tipo Type	Gr	Barcode	€
235	120	28	1,74	†	88	440122	10,40

Tenazas quita espinas

Fish pliers
Pincettes à poissons

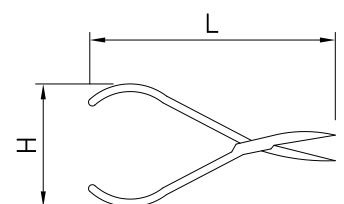

L	H	Gr	Barcode	€
160	80	160	440054	23,00

Corta mariscos forjado
 Forged shellfish cracker
 Pince à crustacés

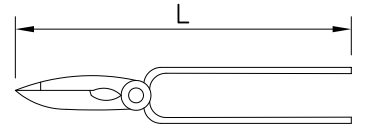

L	Gr	Barcode	€
160	130	440018	20,00

Tenedor marisco
 Seafood fork
 Fourchette à crustacés

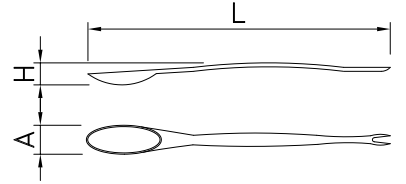

L	H	A	Gr	Barcode	€
230	3	30	180	440056	1,50

Cascañueces
 Nutcracker
 Casse-noix

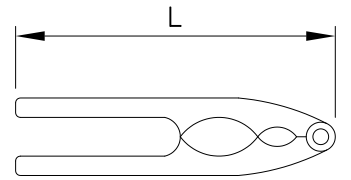

L	Gr	Barcode	€
160	220	440026	18,00

Conjunto sal y pimienta
 Salt and pepper set
 Set poivrière et salière



D	H	Gr	Barcode	€
55	110	200	440050	2,50

Salvamantel extensible
 Extending tablemat
 Dessous de plat extensible

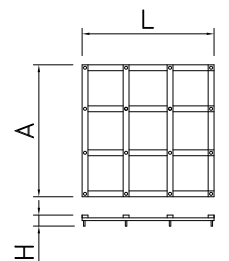

L	A	H	Gr	Barcode	€
360	360	15	250	440908	17,50



Barman
Barman
Barman

Sacacorcho navaja
Corkscrew pocketknife
Tire-bouchon canif

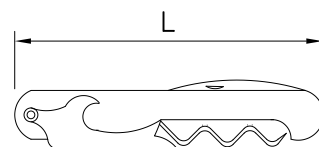

L	Gr	440022	€
110	72	440022	4,50

Sacacorcho Tirolés
Corkscrew
Tire-bouchon

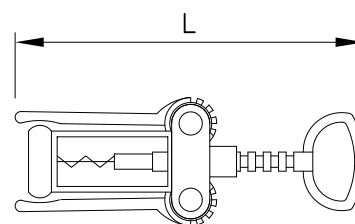

L	Gr	440024	€
170	131	440024	7,00

Abrebotellas
Bottle opener
Ouvreur de bouteille

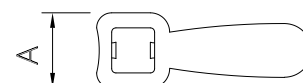
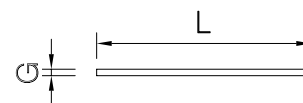

L	A	G	Gr	440044	€
100	35	3	180	440044	2,00

Sacacorchos mural
Wall-mounted corkscrew
Tire-bouchon mural



Espigas macho para sacacorchos de pared 483416

Replacement male spiral for wall-mounted corkscrew 483416
Épis mâles pour tire-bouchon mural 483416



€

483434 **18,00**

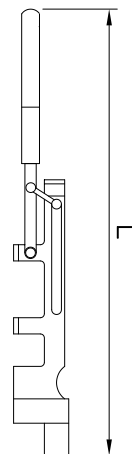

L	Kg	Barcode	€
550	2,52	483416	237,00

Tapón inox
Stainless steel stopper
Bouchon inox



Tapón de cierre hermético para mantener el vino fresco durante más tiempo. Fácil manejo.

Hermetic stopper, for a fresher wine for longer. Easy to use.

Bouchon de fermeture hermétique pour maintenir le vin frais durant plus de temps. Usage facile.

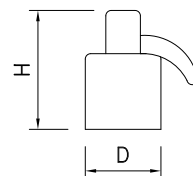

D	H	Gr	Barcode	€
35	80	5,5	483430	8,00

Tapón de corona acero inox
Bottle crown cap in stainless steel
Capsule couronne acier inox

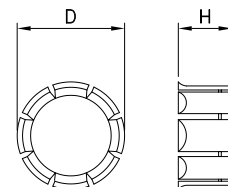

D	H	Gr	Barcode	€
40	20	5	483418	1,80

Tapón vertedor inox (2 ud)
Stainless steel pouring cap (2 pc)
Bouchon verseur en acier inoxydable (2 pc)

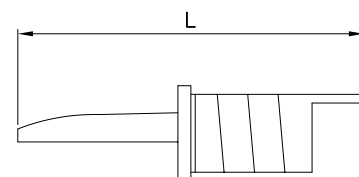

L	Gr	Barcode	€
80	40,00	483420	3,00

Tapón hermético acero inox (2 uds.)
Sealing plug (2 pieces)
Bouchon hermétique acier inox (2 pièces)

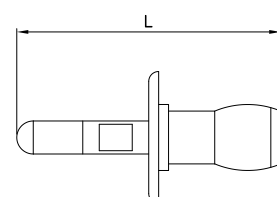

L	Gr	Barcode	€
80	44,16	483422	5,00

Tapón cava cromado

Chromed stopper for sparkling wine
Bouchon pour bouteille de champagne chromé

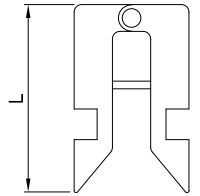

L	Gr	€	
50	89,66	483424	8,75

Anillo acero inox antigoteo para botella de vino

Wine drip collar in stainless steel
Anneau de chute acier inox anti-gouttes pour bouteille de vin

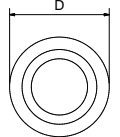
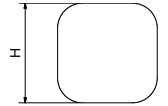

D	H	Gr	€	
40	40	10	483408	2,00

Bomba de vacío para botella de vino

Wine bottle vacuum pump
Tire-bouchon à air pour bouteille de vin

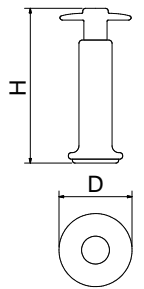

483432 € 3,50

Juego de dos tapones de repuesto para bomba vacío
2 Wine Stoppers for Vacuum pump
2 Bouchons de vin pour Pompe vide d'air

D	H	Gr	€	
50	140	10	483410	9,00

Oxigenador de vino

Wine aerator
Oxygénateur de vin

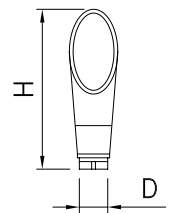

D	H	Gr	€	
24	125	50	483412	16,00

Escanciador de vino

Wine pourer
Verseur

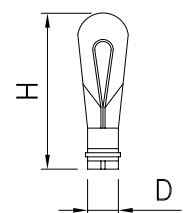

D	H	Gr	€	
15	76	16	483426	5,50

Termómetro digital para botella de vino

Wine bottle digital thermometer

Thermomètre digital pour bouteille de vin



Para controlar la temperatura del vino sin abrir la botella.

Se puede usar en la nevera o refrigerador

Lectura de temperatura instantánea con intervalos de 1°C.

Para botellas de hasta 100 mm. de diámetro.

Pour contrôler la température du vin sans ouvrir la bouteille.

Il peut être utilisé dans la glacière ou réfrigérateur

Lecture de la température instantanée à des intervalles de 1°C.

Pour les bouteilles jusqu'à 100 mm. de diamètre.

To check the wine temperature without opening the bottle.

It can be used in the fridge or in the ice chest.

Instant display of temperature with intervals of 1°C.

For bottles up to 100 mm. diameter.

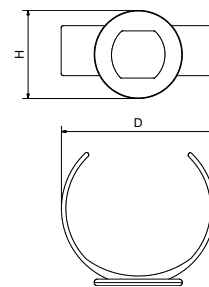

D	H	Gr	Barcode	€
40	70	22	483414	16,00

AD

Coctelera

Shaker

Shaker

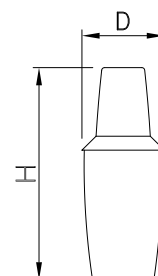

D	H	Gr	Barcode	€
75	160	250	440058	6,00

Pala para hielo en acero inox

Stainless steel ice shovel

Pelle à glaçons en acier inoxydable

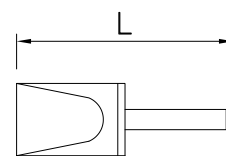

L	Gr	Barcode	€
190	500	474457	19,00

Pinza para cubitos de hielo

Ice tongs

Pinces à glace

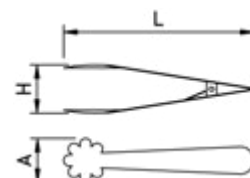
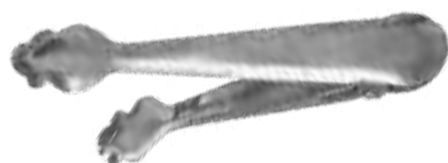

L	A	H	Gr	Barcode	€
190	35	50	100	440008	4,00

Cubitera con tapa de acero inox
Ice bucket with stainless steel lid
Seau à glaçons avec couvercle en acier inoxydable

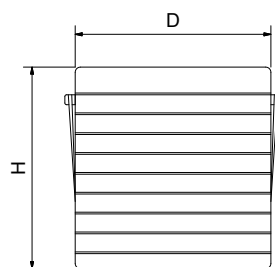

D	H	Gr	Barcode	€
170	175	740	440098	43,50

Champanera acero inox
Champagne cooler bucket in stainless steel
Seau à Champagne acier inox

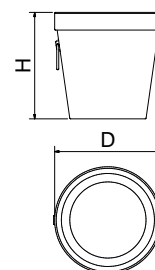

D	H	Gr	Barcode	€
220	250	3.8	442 483404	15,00

Pie de champanera
Champagne cooler stand
Pied pour seau à champagne

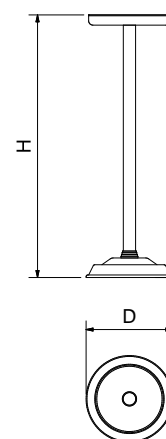

D	H	Kg	Barcode	€
250	750	4,50	483406	47,00

Termo
Thermos flask jug
Thermos

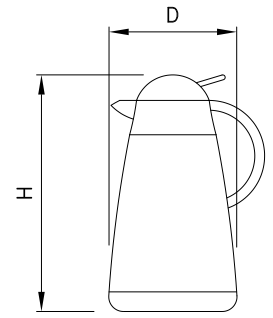

D	H		Gr		€
130	290	2	811	480244	29,00

Cafetera express inox
Express coffee pot
Cafetière express inox

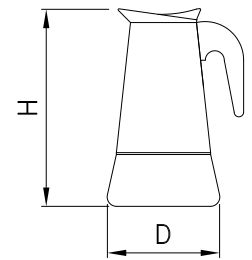

D	H			Gr		€
120	210	9	1	818	480240	25,00

Cafetera italiana tradicional 6 ó 12 tazas
6 or 12 cups traditional Italian coffee-maker
Cafetière italienne traditionnelle 6 ou 12 tasses

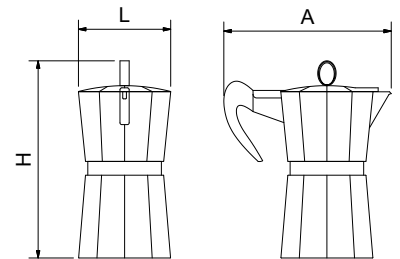

L	A	H		Gr		€
130	200	350	12	850	480242	31,00

Juego de café de 5 piezas para 6 tazas
6 cups coffee set of 5 pieces
Service à café 5 pièces pour 6 tasses

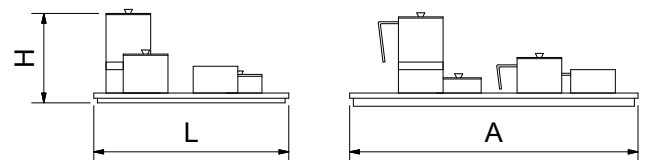

L	A	H		Kg		€
240	355	110	6	1,70	480243	113,00



Servicio a domicilio

Take away & delivery
Livraison à domicile

Caja de reparto/distribución apilable con tapa

Stackable distribution box with lid

Boîte de distribution empilable avec couvercle

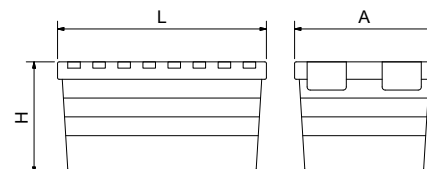

L	A	H		Kg		€
600	400	320	60	2,90	483030	34,00
600	400	360	66	3,55	483034	36,00
600	400	410	77	3,75	483032	39,00

Forro isotermo interior para cajas de reparto / distribución

Inner isothermal lining for delivery / distribution boxes

Doublure intérieure isotherme pour boîtes de livraison / distribution

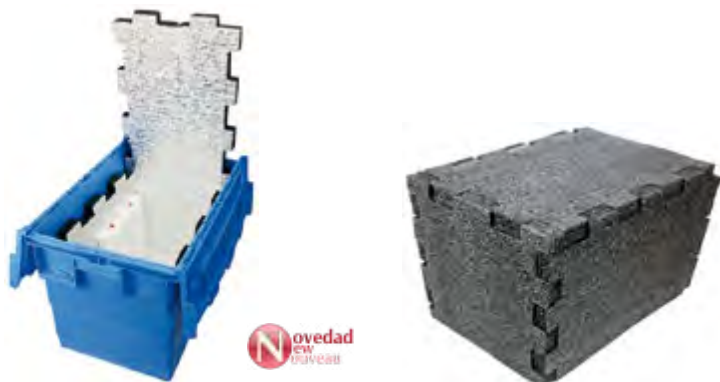

Novedad
New
nouveauté



L	A	H	Gr		€
		300	490	483031	58,50
550	350	380	650	483033	72,50

Contenedor Gastronorm aislamiento térmico

Gastronorm container for thermic isolation
Bac Gastronorm d'isolation thermique



Modelo Model Model	L	A	H	Gr	Barcode	€
1/1 - 120	600	400	170	550	487802	69,00
1/1 - 170	600	400	230	620	487804	74,00
1/1 - 220	600	400	270	710	487806	82,00

AD

Placa eutéctica GN 1/1 acumulador de frío de 0 a -21°C

Eutectic plate GN 1/1 cold accumulator from 0 to -21°C
Plaque eutectique GN 1/1 accumulateur de froid de 0 à -21°C



Novedad
New
Novéauté

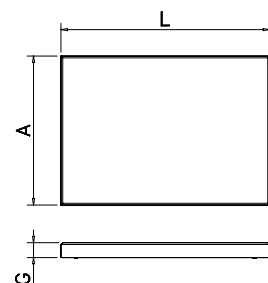

L	A	H	Kg	Barcode	€
530	325	30	5,10	487818	132,00

Contenedor isotérmico Euronorm 82 L.

Isothermal Euronorm container 82 liters
Conteneur isotherme Euronorm 82 L.



Novedad
New
Novéauté



L	A	H	Kg	Barcode	€
690	490	370	1,60	487808	120,00

Envase take away / delivery rectangular con tapa

Take away / delivery rectangular container with lid

Conteneur rectangulaire à emporter ou de livraison avec couvercle



Características:

Fabricado en plástico polipropileno negro, este envase rectangular con tapa es ideal para servir alimentos a domicilio.

Reutilizable, reciclable y además es apto para lavavajillas, frigorífico y microondas sin grill.

Además, a diferencia de otros envases take away, son apilables. Esto permitirá reducir espacio en sus cocinas.



Characteristics:

Made of black polypropylene, this rectangular container with lid is ideal for food delivery service.

It is reusable, recyclable and is also suitable for dishwashers, refrigerators and microwaves without grill.

In addition, unlike other take away containers, they are stackable. This will reduce space in your kitchens.

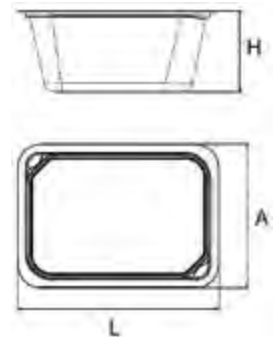

Caractéristiques:

Fabriqué en plastique polypropylène noir, ce contenant rectangulaire avec couvercle est idéal pour servir des aliments à la maison. Il est réutilisable, recyclable et convient également aux lave-vaisselle, réfrigérateurs et micro-ondes sans grill.

De plus, contrairement aux autres contenants à emporter, ils sont empilables. Cela réduira l'espace dans votre cuisine.

L	A	H	Gr	Barcode	€
190	136	76,5	700	480608	3,00

Envase take away / delivery redondo con tapa

Take away / delivery rounded container with lid

Conteneur rond à emporter ou de livraison avec couvercle



Características:

Fabricado en plástico polipropileno negro, este envase redondo con tapa es ideal para servir alimentos a domicilio.

Reutilizable, reciclable y además es apto para lavavajillas, frigorífico y microondas sin grill.

Además, a diferencia de otros envases take away, son apilables. Esto permitirá reducir espacio en sus cocinas.

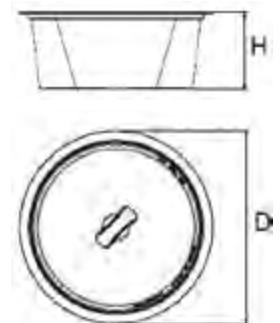

Caractéristiques:

Fabriqué en plastique polypropylène noir, ce contenant rond avec couvercle est idéal pour servir des aliments à la maison. Il est réutilisable, recyclable et convient également aux lave-vaisselle, réfrigérateurs et micro-ondes sans grill.

De plus, contrairement aux autres contenants à emporter, ils sont empilables. Cela réduira l'espace dans votre cuisine.

Characteristics:

Made of black polypropylene, this rounded container with lid is ideal for food delivery service. It is reusable, recyclable and is also suitable for dishwashers, refrigerators and microwaves without grill.

In addition, unlike other take away containers, they are stackable. This will reduce space in your kitchens.

D	H	Gr	Barcode	€
155	62	500	480610	4,00



LAVAMANOS

HAND WASH BASINS
LAVE-MAINS

NOVEDADES

NEWS
NOUVEAUTÉS



192

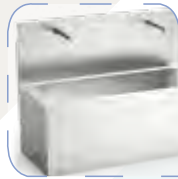

197



197



198



201



201



LAVAMANOS DE ACERO INOXIDABLE DE ACCIONAMIENTO NO MANUAL

HANDS-FREE OPERATED STAINLESS STEEL HAND WASHBASIN
LAVE-MAINS EN ACIER INOXYDABLE ACTIONNEMENT NON MANUEL

Características principales:

A partir de esta página, encontrará una gran variedad de lavamanos inoxidable de accionamiento no manual, cuyo objetivo es facilitar la correcta higiene de las manos evitando que el usuario tenga que tocar con sus manos cualquier parte del mismo. Esto además mitiga el riesgo de contaminación cruzada entre usuarios.

Para mayor efectividad en el lavado de manos, toda nuestra gama es de agua fría y caliente, siendo habitual que el agua salga mezclada aunque hay algunos modelos que permiten elegir entre fría, caliente o mezclada.

Todos nuestros lavamanos cumplen con las normativas vigentes y cuentan con sus certificados correspondientes.

Main characteristics:

From this page on, you will find a wide variety of hands-free operated stainless steel hand washbasins, the objective of which is to prevent the user from touching any part of the device thus obtaining proper hand hygiene. This also mitigates the risk of cross contamination among users.

Our entire range is fitted with inlets for hot and cold water, for a more effective hand washing. Although the most common models operate with mixed water, there are some that allow the user to choose between cold, hot or mixed.

All our sinks comply with current regulations and have their corresponding certificates.

Main characteristics:

À partir de cette page, vous trouverez une grande variété de lave-mains en acier inoxydable d'actionnement non manuelle, dont l'objectif est de faciliter une bonne hygiène des mains en évitant à l'utilisateur d'avoir à en toucher une partie avec ses mains. Cela atténue également le risque de contamination croisée entre les utilisateurs.

Pour une plus grande efficacité du lavage des mains, toute notre gamme est d'eau chaude et froide, il est courant que l'eau sorte mélangée bien qu'il existe certains modèles qui vous permettent de choisir entre froide, chaude ou mixte.

Tous nos lave-mains sont conformes à la réglementation en vigueur et ont leurs certificats correspondants.

LAVAMANOS

WASHBASINS / LAVE-MAIN



**Caño giratorio en
acero inoxidable**
Stainless steel
rotating spout
Jet giratoire en acier
inoxydable



Rebosadero
Overflow
Déversoir

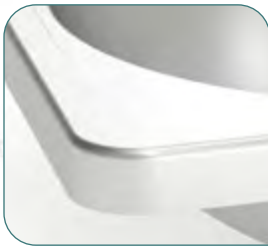

**Esquinas
redondeadas**
Rounded corners
Coins arrondis



**Reborde anti
derrames**
Anti-spill flange
Bride anti-déversement



**Pulsador
temporizado de alta
calidad en acero
inoxidable**
High-quality stainless
steel timed switch
Interrupteur
chronométré en acier
inoxydable de haute
qualité

Lavamanos registrables de agua fría y caliente
Hand wash basin cold and hot water with removable door
Lave-mains avec porte amovible d'eau froide et chaude

061426

061012

061414

XS

Características
Characteristics
Caractéristiques

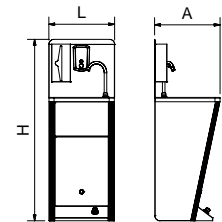
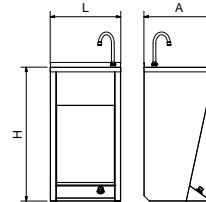
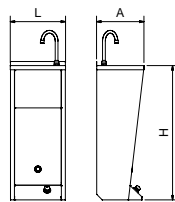

Tipo de accionamiento Operation Accionnement	Pulsador Push button Poussoir	Pulsador Push button Poussoir	Pulsador Push button Poussoir
Caudal Flow Débit	9 l/min	9 l/min	9 l/min
Tipo de agua Type of water Type d'eau	Mezclada Mixed Mélangée	Mezclada Mixed Mélangée	Mezclada Mixed Mélangée
Conjunto peto, jabonera y dispensador Raised backsplash for mobile hand washbasin Dossieret inox postérieur pour lave-mains autonome	-----	Opcional Optional Optionnel	<input checked="" type="checkbox"/>
Papelera integrada Waste bin integrated Corbeille a papier intégrée	<input checked="" type="checkbox"/>	-----	<input checked="" type="checkbox"/>
L	350 mm	450 mm	450 mm
A	300 mm	450 mm	450 mm
H	850 mm	850 mm	1250 mm
Peso / Weight / Poids	9,00 Kg.	11,15 Kg.	14,20 Kg.
Unidades por palet Units per pallet Unités par palette	18	8	8
Tipo de cubeta Type of bowl Type d'évier	Redonda con reborde Rounded with anti-drip edge Arrondi avec rebord	Rectangular con reborde Rectangular with anti-drip edge Rectangulaire avec rebord	Redonda con reborde Rounded with anti-drip edge Arrondi avec rebord
Dimensiones cubeta Bowl dimensions Dimensions évier	Ø 260 mm	370x340 mm	Ø 390 mm
Profundidad cubeta Bowl depth Profondeur évier	115 mm	170 mm	150 mm
	304,00€	295,00€	425,00€

061014

061002

061004

061008

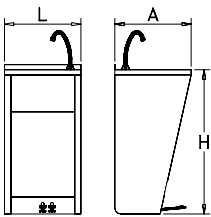
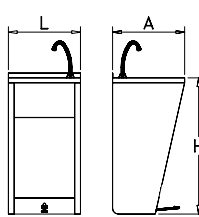
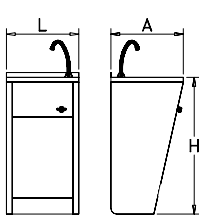
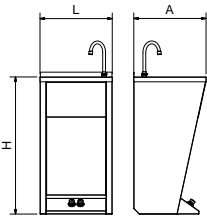

2x Pulsador
2x Push button
2x Poussoir

Pulsador
Push button
Poussoir

Pedal
Pedal
Pédale

2x Pedal
2x Pedal
2x Pédale

9 l/min

9 l/min

7,5 l/min

7,5 l/min

Fría, Caliente o Mezclada
Cold, hot or mixed
Froid, chaud ou mélangé

Mezclada
Mixed
Mélangée

Mezclada
Mixed
Mélangée

Fría, Caliente o Mezclada
Cold, hot or mixed
Froid, chaud ou mélangé

Opcional
Optional
Optionnel

Opcional
Optional
Optionnel

Opcional
Optional
Optionnel

Opcional
Optional
Optionnel

450 mm

450 mm

450 mm

450 mm

450 mm

450 mm

450 mm

450 mm

850 mm

850 mm

850 mm

850 mm

12,00 Kg.

11,96 Kg.

11,96 Kg.

12,66 Kg.

8

8

8

8

Rectangular con reborde
Rectangular with anti-drip edge
Rectangulaire avec rebord

Rectangular con reborde
Rectangular with anti-drip edge
Rectangulaire avec rebord

Rectangular con reborde
Rectangular with anti-drip edge
Rectangulaire avec rebord

Rectangular con reborde
Rectangular with anti-drip edge
Rectangulaire avec rebord

370x340 mm

370x340 mm

370x340 mm

370x340 mm

170 mm

170 mm

170 mm

170 mm

377,00€**344,00€****352,00€****351,00€**

Lavamanos murales
Wall-mounted hand washbasins
Lave-main mural

061422

061402

061424

061432



Características
Characteristics
Caractéristiques

XS

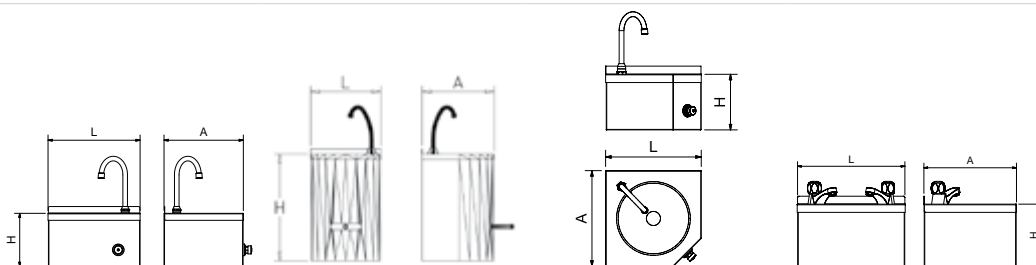

Tipo de accionamiento Operation Accionnement	Pulsador temporizado Timed switch Interrupteur chronométré	Palanca rodilla Knee-operated lever Lever de genou	Pulsador temporizado Timed switch Interrupteur chronométré	2x Pomos 2x Knob 2x Bouton
Caudal Flow Débit	9 l/min	8 l/min	9 l/min	16 l/min
Tipo de agua Type of water Type d'eau	Mezclada Mixed Mélangée	Mezclada Mixed Mélangée	Mezclada Mixed Mélangée	Fría y Caliente Cold and hot Froid et chaud
Caño giratorio Rotating spout Bec tournant de robinet commande	<input checked="" type="checkbox"/>	<input checked="" type="checkbox"/>	<input checked="" type="checkbox"/>	-----
Conjunto peto, jabonera y dispensador Raised backsplash for mobile hand washbasin Dossier inox postérieur pour lave-mains autonome	Opcional Optional Optionnel	Opcional Optional Optionnel	Opcional Optional Optionnel	Opcional Optional Optionnel
Papelera Waste bin Corbeille a papier	Opcional Optional Optionnel	Opcional Optional Optionnel	Opcional Optional Optionnel	Opcional Optional Optionnel
L	350 mm	350 mm	350 mm	350 mm
A	300 mm	300 mm	350 mm	300 mm
H	215 mm	500 mm	205 mm	200 mm
Peso / Weight / Poids	3,91 Kg.	8,00 Kg.	3,00 Kg.	2,32 Kg.
Unidades por palet Units per pallet Unités par palette	72	24	72	72
Tipo de cubeta Type of bowl Type d'évier	Redonda con reborde Rounded with anti-drip edge Arrondi avec rebord	Redonda con reborde Rounded with anti-drip edge Arrondi avec rebord	Redonda Rounded Arrondi	Redonda con reborde Rounded with anti-drip edge Arrondi avec rebord
Dimensiones cubeta Bowl dimensions Dimensions évier	Ø 260 mm	Ø 260 mm	Ø 260 mm	Ø 260 mm
Profundidad cubeta Bowl depth Profondeur évier	115 mm	115 mm	140 mm	115 mm
	160,00€	289,00€	310,00€	199,00€

061202

061212

061406

061204

061208

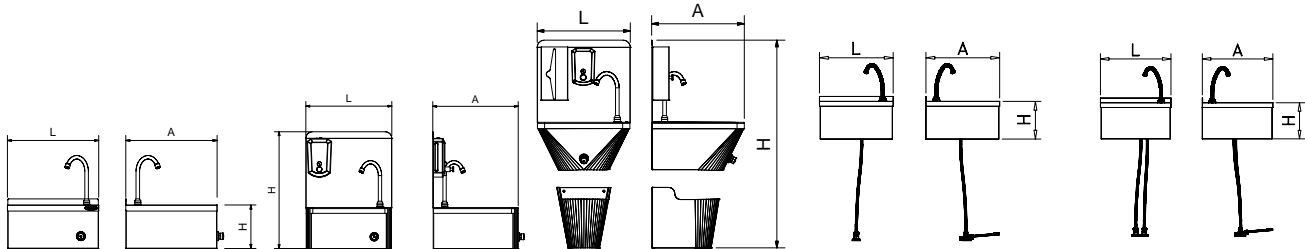

Pulsador temporizado Timed switch Interrupteur chronométré	Pulsador temporizado Timed switch Interrupteur chronométré	Pulsador temporizado Timed switch Interrupteur chronométré	Pedal Pedal Pédale	2x Pedal 2x Pedal 2x Pédale
9 l/min	9 l/min	9 l/min	7,5 l/min	7,5 l/min
Mezclada Mixed Mélangée	Mezclada Mixed Mélangée	Mezclada Mixed Mélangée	Mezclada Mixed Mélangée	Fría, Caliente o Mezclada Cold, hot or mixed Froid, chaud ou mélangé
<input checked="" type="checkbox"/>	<input checked="" type="checkbox"/>	<input checked="" type="checkbox"/>	<input checked="" type="checkbox"/>	<input checked="" type="checkbox"/>
Opcional Optional Optionnel	<input checked="" type="checkbox"/> *Dispensador tissues no Not tissues dispenser Dispensateur de tissus non	<input checked="" type="checkbox"/>	Opcional Optional Optionnel	Opcional Optional Optionnel
Opcional Optional Optionnel	Opcional Optional Optionnel	<input checked="" type="checkbox"/>	Opcional Optional Optionnel	Opcional Optional Optionnel
450 mm	453 mm	450 mm	450 mm	450 mm
450 mm	450 mm	450 mm	450 mm	450 mm
215 mm	615 mm	1050 mm	215 mm	215 mm
5,59 Kg.	7,00 Kg.	10,50 Kg.	5,46 Kg.	6,60 Kg.
36	36	16	36	36
Redonda con reborde Rounded with anti-drip edge Arrondi avec rebord	Redonda con reborde Rounded with anti-drip edge Arrondi avec rebord	Redonda con reborde Rounded with anti-drip edge Arrondi avec rebord	Redonda con reborde Rounded with anti-drip edge Arrondi avec rebord	Redonda con reborde Rounded with anti-drip edge Arrondi avec rebord
Ø 390 mm	Ø 390 mm	Ø 390 mm	Ø 390 mm	Ø 390 mm
150 mm	150 mm	150 mm	150 mm	150 mm
197,00€	348,00€	401,00€	220,00€	278,00€

Lavamanos registrables electrónicos
Sensor operated hand washbasins with and without removable door
Lave-mains électriques autonomes

061462

061010

061418

Características
Characteristics
Caractéristiques

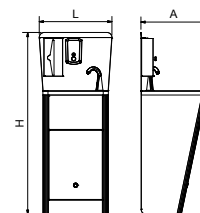
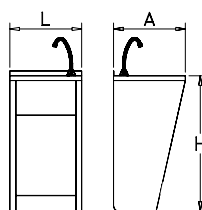
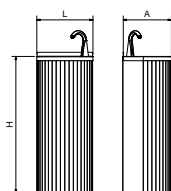

Tipo de accionamiento
Operation
Accionnement

Sensor sin contacto
Non-contact sensor
Capteur sans contact

Sensor sin contacto
Non-contact sensor
Capteur sans contact

Sensor sin contacto
Non-contact sensor
Capteur sans contact

Caudal
Flow
Débit

8 l/min

8 l/min

8 l/min

Tipo de agua
Type of water
Type d'eau

Mezclada
Mixed
Mélangée

Mezclada
Mixed
Mélangée

Mezclada
Mixed
Mélangée



Conjunto peto, jabonera y dispensador
Raised backsplash for mobile hand washbasin
Dosseret inox postérieur pour lave-mains autonome

Opcional
Optional
Optionnel



Papelera integrada
Waste bin integrated
Corbeille à papier intégrée



L	350 mm	450 mm	450 mm
A	300 mm	450 mm	450 mm
H	850 mm	850 mm	1250 mm
Peso / Weight / Poids	7,00 Kg.	12,54 Kg.	15,20 Kg.
Unidades por palet Units per pallet Unités par palette	18	8	8
Tipo de cubeta Type of bowl Type d'évier	Redonda con reborde Rounded with anti-drip edge Arrondi avec rebord	Rectangular con reborde Rectangular with anti-drip edge Rectangulaire avec rebord	Redonda con reborde Rounded with anti-drip edge Arrondi avec rebord
Dimensiones cubeta Bowl dimensions Dimensions évier	Ø 260 mm	370x340 mm	Ø 390 mm
Profundidad cubeta Bowl depth Profondeur évier	115 mm	170 mm	150 mm
Funcionamiento grifo Tap operation Opération de robinet	2x  CR123	2x  CR123	2x  CR123
	556,00€	449,00€	531,00€

Lavamanos murales electrónicos
Sensor operated wall-mounted hand washbasins
Lave-mains mural électronique

061404





061448

061210

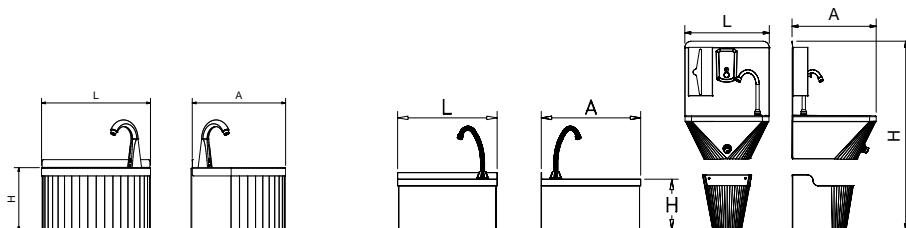
061410

Características
Characteristics
Caractéristiques



Tipo de accionamiento Operation Accionnement	Sensor sin contacto Non-contact sensor Capteur sans contact	Sensor sin contacto Non-contact sensor Capteur sans contact	Sensor sin contacto Non-contact sensor Capteur sans contact	Sensor sin contacto Non-contact sensor Capteur sans contact
Caudal Flow Débit	8 l/min	8 l/min	8 l/min	8 l/min
Tipo de agua Type of water Type d'eau	Mezclada Mixed Mélangée	Fría, Caliente o Mezclada Cold, hot or mixed Froid, chaud ou mélangé	Mezclada Mixed Mélangée	Mezclada Mixed Mélangée
Conjunto peto, jabonera y dispensador Raised backsplash for mobile hand washbasin Dossieret inox postérieur pour lave-mains autonome	-----	-----	Opcional Optional Optionnel	<input checked="" type="checkbox"/>
Papelera Waste bin Corbeille a papier	Opcional Optional Optionnel	Opcional Optional Optionnel	Opcional Optional Optionnel	<input checked="" type="checkbox"/>
L	350 mm	350 mm	450 mm	450 mm
A	300 mm	300 mm	450 mm	450 mm
H	200 mm	200 mm	215 mm	1050 mm
Peso / Weight / Poids	6,00 Kg.	6,00 Kg.	6,14 Kg.	12,66 Kg.
Unidades por palet Units per pallet Unités par palette	72	72	36	16
Tipo de cubeta Type of bowl Type d'évier	Redonda con reborde Rounded with anti-drip edge Arrondi avec rebord	Redonda con reborde Rounded with anti-drip edge Arrondi avec rebord	Redonda con reborde Rounded with anti-drip edge Arrondi avec rebord	Redonda con reborde Rounded with anti-drip edge Arrondi avec rebord
Dimensiones cubeta Bowl dimensions Dimensions évier	Ø 260 mm	Ø 260 mm	Ø 390 mm	Ø 390 mm
Profundidad cubeta Bowl depth Profondeur évier	115 mm	115 mm	150 mm	150 mm
Funcionamiento grifo Tap operation Opération de robinet	2x  CR123	2x  CR123	2x  CR123	2x  CR123
	391,00€	378,00€	324,00€	489,00€

PORTATIL SIN NECESIDAD DE TOMAS DE AGUA NI DESAGÜE

PORTABLE WITH NO NEED FOR WATER OR DRAINAGE OUTLETS
PORTABLE, SANS BESOIN DE SORTIES D'EAU OU DE DRAINAGE

Características principales:

Portabilidad: Un lavamanos autónomo de Fricosmos es fácilmente transportable y no requiere de instalaciones complicadas. Puede ser utilizado en diferentes ubicaciones según las necesidades, lo cual lo hace ideal para eventos al aire libre, ferias, hospitales, escuelas, oficinas y cualquier otro lugar donde se necesite un lavamanos adicional de forma temporal o permanente.

Funcionamiento sin conexión a la red de agua: Los lavamanos autónomos de Fricosmos están equipados con sistemas de almacenamiento de agua y bombas que les permiten funcionar sin necesidad de estar conectados a la red de agua. Esto es especialmente útil en lugares donde no hay acceso a una fuente de agua cercana o en situaciones de emergencia.

Higiene y seguridad: Estos lavamanos fabricados en acero inoxidable facilitan su limpieza y desinfección. Además, opcionalmente cuentan con dispensadores de jabón y de papel, lo que fomenta una correcta higiene de manos y reduce la propagación de enfermedades.

Ahorro de tiempo y recursos: Al tener un lavamanos autónomo de Fricosmos, no es necesario que las personas se desplacen largas distancias para lavarse las manos. Esto ahorra tiempo y recursos, ya que se evitan los traslados innecesarios y se fomenta una buena higiene en el lugar donde se requiere.

Cumplimiento normativo: Estos lavamanos cumplen con las normativas y regulaciones sanitarias vigentes, lo cual es especialmente importante en entornos comerciales y de atención médica. Esto garantiza que se cumplan los estándares de higiene y se mantenga un entorno seguro para los usuarios.

Estas son solo algunas de las ventajas de un lavamanos autónomo de Fricosmos. Es importante tener en cuenta que las características y especificaciones pueden variar según el modelo específico que elijas. Si estás considerando adquirir un lavamanos autónomo, te recomendaría investigar más sobre los productos de Fricosmos y sus características para asegurarte de que se ajusten a tus necesidades particulares.

Main characteristics:

Portability: A self-contained hand wash basin from Fricosmos is easily transportable and does not require complicated installations. It can be used in different locations as needed, making it ideal for outdoor events, fairs, hospitals, schools, offices, and any other place where an additional hand wash basin is needed temporarily or permanently.

Operation without water connection: Fricosmos self-contained hand wash basins are equipped with water storage systems and pumps that allow them to function without being connected to the water supply. This is especially useful in locations where there is no access to a nearby water source or in emergency situations.

Hygiene and safety: These hand wash basins, made of stainless steel, facilitate cleaning and disinfection. Additionally, they optionally come with soap and paper dispensers, promoting proper hand hygiene and reducing the spread of diseases.

Time and resource-saving: Having a self-contained hand wash basin from Fricosmos eliminates the need for people to travel long distances to wash their hands. This saves time and resources by avoiding unnecessary travel and promoting good hygiene at the required location.

Compliance with regulations: These hand wash basins comply with current sanitary regulations and standards, which is especially important in commercial and healthcare settings. This ensures that hygiene standards are met and maintains a safe environment for users.

These are just some of the advantages of a self-contained hand wash basin from Fricosmos. It's important to note that features and specifications may vary depending on the specific model you choose. If you're considering acquiring a self-contained hand wash basin, I would recommend researching more about Fricosmos products and their features to ensure they fit your specific needs.

Main characteristics:

Portabilité : Un évier autonome de Fricosmos est facilement transportable et ne nécessite pas d'installations compliquées. Il peut être utilisé dans différents endroits selon les besoins, ce qui le rend idéal pour les événements en plein air, les foires, les hôpitaux, les écoles, les bureaux et tout autre lieu nécessitant un évier supplémentaire de manière temporaire ou permanente.

Fonctionnement sans connexion à l'eau : Les éviers autonomes de Fricosmos sont équipés de systèmes de stockage d'eau et de pompes qui leur permettent de fonctionner sans être connectés au réseau d'eau. Cela est particulièrement utile dans les endroits où il n'y a pas d'accès à une source d'eau à proximité ou dans les situations d'urgence.

Hygiène et sécurité : Ces éviers en acier inoxydable facilitent le nettoyage et la désinfection. De plus, ils sont facultativement équipés de distributeurs de savon et de papier, ce qui favorise une bonne hygiène des mains et réduit la propagation des maladies.

Économie de temps et de ressources : En disposant d'un évier autonome de Fricosmos, il n'est pas nécessaire de parcourir de longues distances pour se laver les mains. Cela permet d'économiser du temps et des ressources en évitant les déplacements inutiles et en favorisant une bonne hygiène à l'endroit où cela est nécessaire.

Conformité aux réglementations : Ces éviers respectent les réglementations sanitaires en vigueur, ce qui est particulièrement important dans les environnements commerciaux et de soins de santé. Cela garantit le respect des normes d'hygiène et maintient un environnement sûr pour les utilisateurs.

Ce ne sont là que quelques-uns des avantages d'un évier autonome de Fricosmos. Il est important de noter que les caractéristiques et les spécifications peuvent varier en fonction du modèle spécifique que vous choisissez. Si vous envisagez d'acquérir un évier autonome, je vous recommande de vous renseigner davantage sur les produits Fricosmos et leurs caractéristiques pour vous assurer qu'ils répondent à vos besoins spécifiques.

LAVAMANOS AUTÓNOMOS

SELF-CONTAINED WASHBASINS / LAVE-MAINS AUTONOMES



Rebosadero
Overflow
Déversoir



Caño giratorio en
acero inoxidable
Stainless steel
rotating spout
Jet giratoire en acier
inoxydable

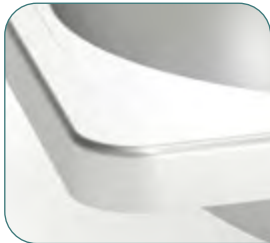

Esquinas
redondeadas
Rounded corners
Coins arrondis



Reborde anti
derrames
Anti-spill flange
Bride anti-déversement



Papelera integrada
Waste bin integrated
Corbeille a papier
intégrée



Trampilla
basculante
Swing lid
Trappe basculante



Pedal hidráulico
Hydraulic pedal
Pédale hydraulique



Video



Lavamanos autónomos
Self-contained washbasins
Lave-mains autonomes

061428

061430

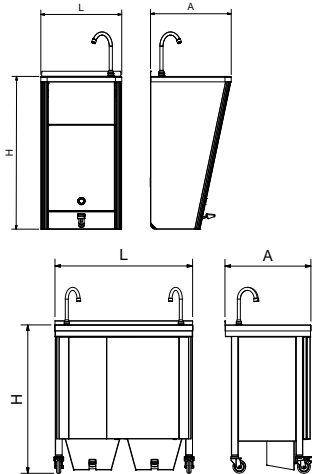

Tipo de accionamiento Operation Accionnement	Pulsador hidráulico tipo pedal Pedal type hydraulic push button Poussoir hydraulique type pédale	Pulsador hidráulico tipo bomba Pump type hydraulic push button Poussoir hydraulique type pompe
Caudal Flow Débit	2 l/min	1 l/min
Requiere toma eléctrica Electrical outlet required Requiert prise d'électricité	-----	-----
Agua fría Cold water Eau froide	<input checked="" type="checkbox"/>	<input checked="" type="checkbox"/>
Agua caliente Hot water Eau chaude	Opcional Optional Optionnel	Opcional Optional Optionnel
Potencia Power Puissance	-----	-----
Caño giratorio Rotating spout Bec tournant de robinet commande	<input checked="" type="checkbox"/>	<input checked="" type="checkbox"/>
Conjunto peto, jabonera y dispensador Raised backsplash for mobile hand washbasin Dossieret inox postérieur pour lave-mains autonome	Opcional Optional Optionnel	Opcional Optional Optionnel
Papelera integrada Waste bin integrated Corbeille a papier intégrée	<input checked="" type="checkbox"/>	<input checked="" type="checkbox"/>
Ruedas Wheels Rouelles	2	2
L	450 mm	450 mm
A	450 mm	450 mm
H	850 mm	850 mm
Peso / Weight / Poids	15,00 Kg.	15,00 Kg.
Unidades por palet Units per pallet Unités par palette	8	8
Tipo de cubeta Type of bowl Type d'évier	Redonda con reborde Rounded with anti-drip edge Arrondi avec rebord	Redonda con reborde Rounded with anti-drip edge Arrondi avec rebord
Dimensiones cubeta Bowl dimensions Dimensions évier	Ø 390 mm	Ø 390 mm
Profundidad cubeta Bowl depth Profondeur évier	150 mm	150 mm
Bidones incluidos Plastic tanks included Bidons inclus	2	2
Capacidad agua limpia Clean water tank capacity Capacité eau propre	15 l.	10 l.
Capacidad agua sucia Dirty water tank capacity Capacité eau sale	15 l.	10 l.

572,00€

538,00€

061474

061464

061468

061466



2x Pulsador hidráulico tipo pedal
Pedal type hydraulic push button
Poussoir hydraulique type pédale

Sensor sin contacto
Non-contact sensor
Capteur sans contact

Pulsador accionamiento automático
Automatic operation push button
Poussoir accionnement automatique

2x Pulsador accionamiento automático
Automatic operation push button
Poussoir accionnement automatique

2 x 2 l/min

2 l/min

2 l/min

2 l/min

Batería
Battery
Batterie

Batería
Battery
Batterie

Opcional
Optional
Optionnel

Opcional
Optional
Optionnel

Opcional
Optional
Optionnel

12 V.

12 V. & 220v. - 50-60Hz.

3500W - 230v. - 50Hz.

Opcional
Optional
Optionnel

Opcional
Optional
Optionnel

Opcional
Optional
Optionnel

4

2

2

2

800 mm

450 mm

450 mm

450 mm

500 mm

450 mm

450 mm

450 mm

850 mm

850 mm

850 mm

850 mm

24,00 Kg.

15,00 Kg.

17,00 Kg.

18,00 Kg.

2

8

8

8

Rectangular con reborde
Rectangular with anti-drip edge
Rectangulaire avec rebord

Redonda con reborde
Rounded with anti-drip edge
Arrondi avec rebord

Redonda con reborde
Rounded with anti-drip edge
Arrondi avec rebord

Redonda con reborde
Rounded with anti-drip edge
Arrondi avec rebord

340x370 mm

Ø 390 mm

Ø 390 mm

Ø 390 mm

150 mm

150 mm

150 mm

150 mm

4

2

2

2

2 x 20 l.

15 l.

15 l.

10 l.

2 x 20 l.

15 l.

15 l.

10 l.

1.512,00€

713,00€

705,00€

1.177,00€

Accesorios para lavamanos portátiles autónomos

Mobile and autonomous hand wash basins accessories
Accessoires pour lave-mains sur pied autonome et portable



Opción de agua caliente para lavamanos autónomo Optional hot water for mobile washbasin Eau chaude optionnelle pour lave-mains portables						
	Potencia Power Puissance	Tensión Voltage Tension	Frecuencia Frequency Fréquence	Modelos Models Modèles		€
	34°C	100 W	220 V	50/60 Hz	061428 061430 061468 061474	061450 48,00
	34°C	100 W	12 V		061428 061430 061468 061474	061452 167,00
	34°C	200 W	220 V	50/60 Hz	061428 061430 061468 061474	061454 91,00
	50°C	3.500 W	230 V	50/60 Hz	061468	461456 265,00

Kit para temperatura ambiente inferior a 15 °C.
Accessory for room temperature below 15 °C.
Kit pour température ambiante moins de 15 °C.

Conjunto peto, jabonera y dispensador tissues para lavamanos autónomo

Backsplash, soap dispenser and tissues dispenser set for mobile hand washbasin
Dossieret inox postérieur pour lave-mains autonome

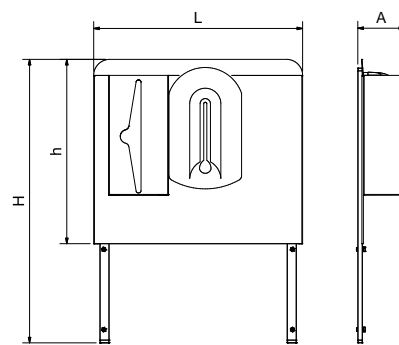

	L	A	H	h	Kg		€
	453	110	600	400	3	060610	127,00
	453	110	600	400	3,5	060614	110,00

Kit de conexión a red de agua para lavamanos autónomo

Water mains connection kit for mobile washbasin
Kit de raccordement au réseau d'eau pour lave-mains autonome



L	A	H	Gr		€
230	192	430	400	061456	47,00

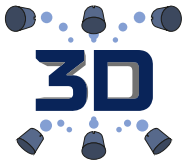

Características:

El novedoso sistema dispone de numerosos puntos de salida de agua mezclada distribuidos por la superficie del seno y orientados de tal manera que posibilita un óptimo y homogéneo lavado de manos sin prácticamente necesidad de moverlas, a la vez que se produce un ahorro considerable en el consumo de agua.

Asimismo, incorpora petos anti-salpicaduras soldados en la parte trasera y en los laterales de manera semi-envolvente, así como un dispensador de jabón automático, para garantizar un uso sin contacto. Todo ello se sirve montado de fábrica.

Characteristics:

This innovative system has several mixed water outlet points distributed over the surface of the basin and oriented in such a way that it allows an optimal and homogeneous hand washing with literally no need to move them and with great savings in water consumption simultaneously. In addition, it has rear and lateral welded backsplashes in a wraparound design, as well as an automatic soap dispenser for a totally hands-free use. Everything is factory assembled.

Caractéristiques:

Le nouveau système dispose de nombreux points de sortie d'eau mélangée répartis sur la surface de l'évier et orientés de manière à permettre un lavage des mains optimal et homogène sans pratiquement avoir besoin de les déplacer, tout en réalisant en même temps des économies considérables dans la consommation de l'eau.

De même, il intègre des dossierés anti-éclaboussures soudés au dos et sur les côtés de manière semi-enveloppante, ainsi qu'un distributeur de savon automatique, pour garantir une utilisation sans contact. Tout cela se livre monté en usine.

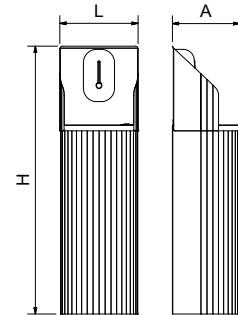
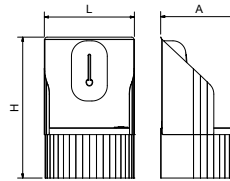

Tipo de accionamiento Operation Accionnement	Sensor sin contacto Non-contact sensor Capteur sans contact	Sensor sin contacto Non-contact sensor Capteur sans contact
Caudal Flow Débit	14 l/min	14 l/min
Tipo de agua Type of water Type d'eau	Mezclada Mixed Mélangée	Mezclada Mixed Mélangée
L	352 mm	352 mm
A	303 mm	303 mm
H	551 mm	1.205 mm
Peso / Weight / Poids	5,20 Kg.	9,50 Kg.
Unidades por palet Units per pallet Unités par palette	18	6
Tipo de cubeta Type of bowl Type d'évier	Redonda con reborde Rounded with anti-drip edge Arrondi avec rebord	Redonda con reborde Rounded with anti-drip edge Arrondi avec rebord
Dimensiones cubeta Bowl dimensions Dimensions évier	Ø 260 mm	Ø 260 mm
Profundidad cubeta Bowl depth Profondeur évier	115 mm	115 mm
Funcionamiento grifo Tap operation Opération de robinet	4x  AA	4x  AA

563,00€

673,00€

Conjunto lavamanos y fregadero mural
 Double bowl wall-mounted hand wash basin-sink
 Évier lave-mains suspendu à deux bacs



Provisto de mezclador antirretorno
 Supplied with non-return mixing valve
 Munies de valve antiretour mélangeuse

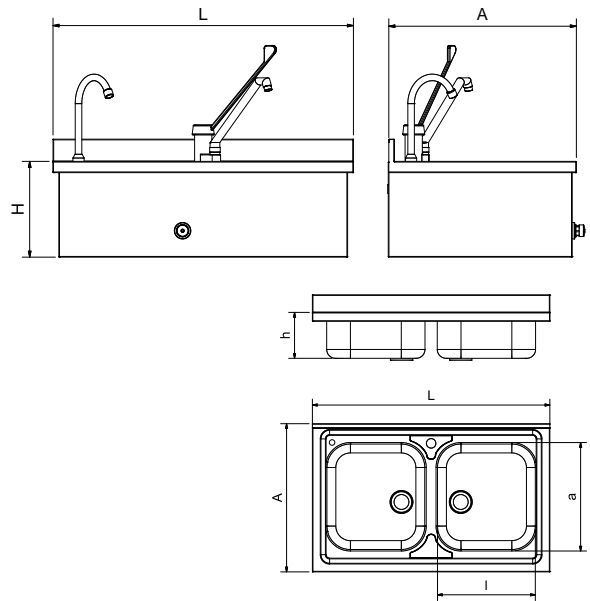

L	A	H	I	a	h	Kg	Barcode	€
800	500	255	330	360	120	12	054202	559,00

Conjunto lavamanos y fregadero mural XS
 Double tank wall-mounted hand wash basin-sink XS model
 Évier lave-mains suspendu à deux bacs XS



Provisto de mezclador antirretorno
 Supplied with non-return mixing valve
 Munies de valve antiretour mélangeuse

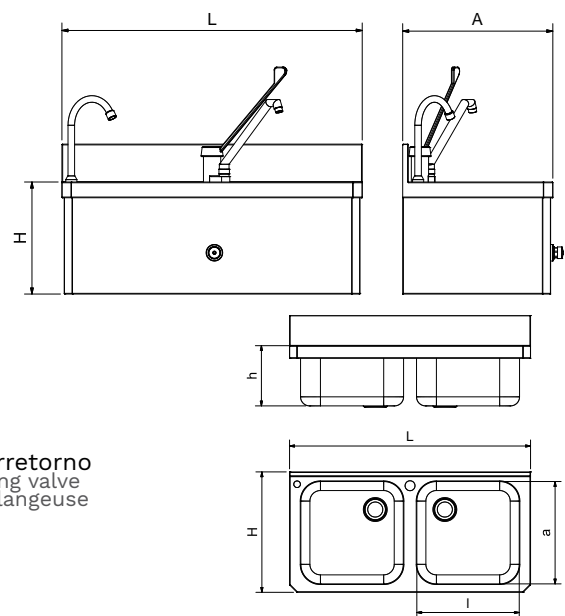

L	A	H	I	a	h	Kg	Barcode	€
800	400	300	340	340	200	15,5	054204	758,00

Lavamanos mural colectivo de rodilla agua fría y caliente

Knee-operated hot and cold water wall-mounted collective washbasin

Lave-main mural collectif à actionnement par genou eau froide et chaude



062020



55,00



412

Espejo Inox
Stainless steel mirror
Miroir inox



065004



661,00



409

Urinario inox
Stainless steel urinal
Urinoir inox



Provisto de mezclador antirretorno
Supplied with non-return mixing valve
Munies de valve antiretour mélangeuse

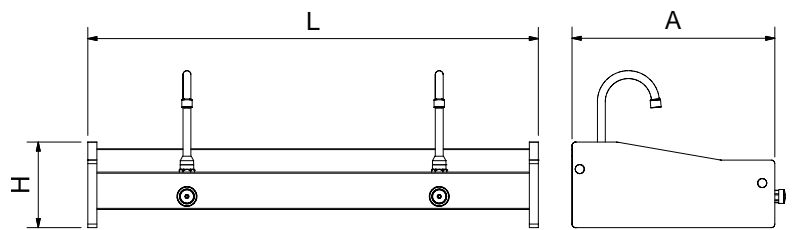

L	A	H	⌵	Kg	Barcode	€
1.000	450	190	2	12	061436	467,00
1.500	450	190	3	17	061438	625,00
2.000	450	190	4	22	061440	743,00

Lavamanos mural colectivo

Wall-mounted collective washbasin

Lave-main mural collectif



Sin accesorios ni taladros.
Without accessories or drills
Sans accessoires ni poinçonnages

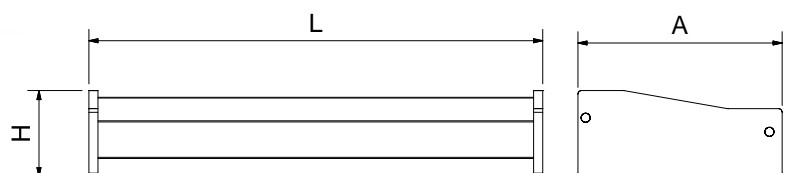

241

Configure este lavamanos incorporando la grifería que mas se ajuste a sus necesidades.
You can form this washbasin by incorporating the taps that best suit your needs.
Vous pouvez former ce lave-mains en intégrant les robinets qui conviennent le mieux à vos besoins.

L	A	H	Kg	Barcode	€
1.000	450	190	10	061442	385,00
1.500	450	190	14	061444	465,00
2.000	450	190	18	061446	527,00

Pie inox para lavamanos mural colectivo

Stainless steel pedestal for collective hand washbasins
Pied inox pour lave-mains collectif



Características principales:

Este producto convierte un lavamanos mural colectivo en un lavamanos con pie. Mejora el aspecto al esconder todas las conexiones detrás de los pies. Aumenta la estabilidad. Fabricado enteramente en acero inoxidable.

Main characteristics:

This accessory converts our wall-mounted collective washbasins in standing models. It hides all the connections behind the supports, for a better looking. It increases the stability. Made entirely of stainless steel.

Caractéristiques principales:

Ce produit transforme nos lave-main mural collectif dans modèles sur pieds. Il cache toutes les connexions derrière les pieds, pour une plus belle apparence. Il augmente la stabilité. Fabriqué entièrement en acier inoxydable.

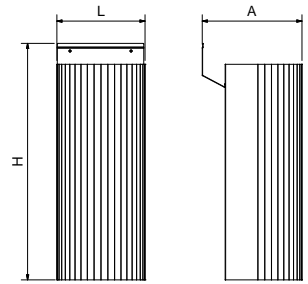

L	A	H	Kg	Barcode	€
317	392	930	5,50	061434	159,00

Lavamanos quirúrgico mural con grifería

Hand washbasin for operating room with taps
Lave-mains chirurgical mural avec robinet



Características principales:

Fabricado en acero inoxidable, este lavamanos quirúrgico está especialmente diseñado para que dos usuarios simultáneos puedan lavarse las manos aplicando la técnica de lavado de manos quirúrgico. Incorpora un peto trasero de 400 mm de altura y una cubeta de gran profundidad. Este modelo incluye dos grifos 463208 de accionamiento a codo, para evitar el contacto con las manos.

*El peto no incluye los taladros ya que en cada quirófano se necesitarán a una altura y distancia diferentes, en función de las tomas de agua disponibles. Asimismo también permitirá elegir otros grifos si se desea.

Main characteristics:

Made of stainless steel, this hand washbasin for operating room is specially designed to allow two users washing their hands simultaneously using the surgical hand washing technique. It incorporates a rear backsplash of 400 mm high and a deep tank. This model includes two elbow-operated taps 463208, to avoid hand contact.

*The backsplash is provided without holes since every operating room has their own water outlets at a different height and distance. It will also allow you to choose other faucets if desired.

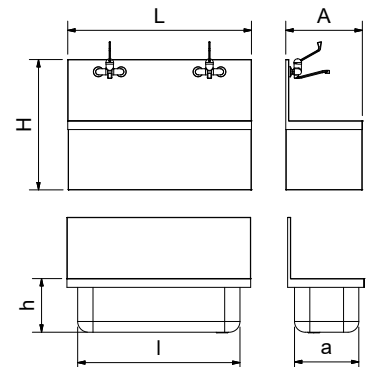

Caractéristiques principales:

Fabriqué en acier inoxydable, ce lave-mains chirurgical est spécialement conçu pour que deux utilisateurs simultanés puissent se laver les mains en utilisant la technique de lavage chirurgical des mains. Il intègre un dossier arrière de 400 mm de hauteur et une cuve profonde. Ce modèle comprend deux robinets 463208 avec actionnement à coude, pour éviter tout contact avec les mains.

*Le dossier ne comprend pas de perçage car dans chaque salle d'opération, il sera nécessaire à une hauteur et une distance différentes, en fonction des prises d'eau disponibles. Il vous permettra également de choisir d'autres robinets si vous le souhaitez.

L	A	H	I	a	h	Kg	Barcode	€
1.200	500	850	1.060	420	350	13,75	061478	1.386,00

Lavamanos quirúrgico doble con grifos electrónicos

Double surgical sink with electronic taps

Lave-mains chirurgical double avec robinets électroniques



Caractéristiques principales:

Fabrique en acier inoxydable, cet évier est spécialement conçu pour les blocs opératoires. Convient pour deux utilisateurs simultanés, car il comprend 2 robinets muraux électroniques 460808. Son activation par capteur de proximité favorise le lavage des mains sans contact, évitant ainsi la contamination croisée. Le dossier n'a pas de trous afin que chaque installateur puisse l'adapter à la hauteur des prises d'eau, en tenant compte que les robinets doivent permettre aux mains d'être au-dessus des coudes.

Características principales:

Fabricado en acero inoxidable, este lavamanos está especialmente diseñado para quirófanos.

Apto para dos usuarios simultáneos, ya que incluye 2 grifos electrónicos a pared 460808. Su activación mediante sensor de proximidad favorece el lavado de manos sin contacto, evitando así contaminación cruzada.

El peto no lleva taladros para que cada instalador lo pueda adaptar a la altura de las tomas de agua, teniendo en cuenta que los grifos deberán permitir que las manos estén por encima de los codos.



Funcionamiento a pilas
Batteries functioning
Fonctionnement a piles

Main characteristics:

Made of stainless steel, this sink is specially designed for operating rooms.

Suitable for two simultaneous users, as it includes 2 460808 electronic wall-mounted taps. Proximity sensor activation for a contactless hand washing, to avoid cross contamination.

The backsplash has no holes so that it can be adapted to the desired height in accordance with the water inlets, taking into account that the taps must allow the hands to be above the elbows.

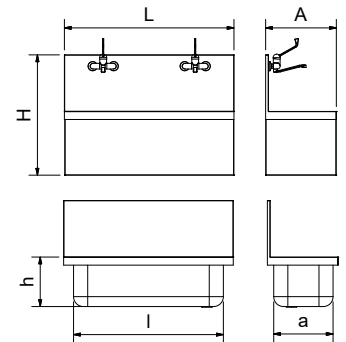

L	A	H	I	a	h	Kg	Barcode	€
1.200	500	850	1.060	420	350	13,75	061476	1.691,00

Lavamanos quirúrgico con grifos mixtos

Surgical sink with mixed taps

Lave-mains chirurgical avec robinets mixtes



Caractéristiques principales:

Fabrique en acier inoxydable, cet évier est spécialement conçu pour les blocs opératoires. Convient pour deux utilisateurs en même temps, car il comprend 2 robinets : un électronique (460808) et un autre à levier unique avec coude (463218). Les deux robinets permettent leur activation sans contact avec les mains, ce qui favorise une hygiène sans contamination croisée.

Le dossier n'a pas de trous afin que chaque installateur puisse l'adapter à la hauteur des prises d'eau, en tenant compte que les robinets doivent permettre aux mains d'être au-dessus des coudes.

Características principales:

Fabricado en acero inoxidable, este lavamanos está especialmente diseñado para quirófanos.

Apto para dos usuarios simultáneos, ya que incluye 2 grifos: uno electrónico (460808) y otro monomando de activación con codo (463218). Ambos grifos permiten su activación sin contacto con las manos, con lo que favorece la higiene sin contaminación cruzada.

El peto no lleva taladros para que cada instalador lo pueda adaptar a la altura de las tomas de agua, teniendo en cuenta que los grifos deberán permitir que las manos estén por encima de los codos.



Funcionamiento a pilas
Batteries functioning
Fonctionnement a piles

Main characteristics:

Made of stainless steel, this sink is specially designed for operating rooms.

Suitable for two simultaneous users, as it includes 2 taps: an electronically-operated one (460808) and an elbow operated one (463218). Both of them allow a hygienic hands-free activation to avoid cross contamination.

The backsplash has no holes so that it can be adapted to the desired height in accordance with the water inlets, taking into account that the taps must allow the hands to be above the elbows.

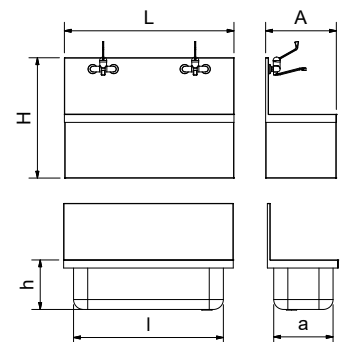

L	A	H	I	a	h	Kg	Barcode	€
1.200	500	850	1.060	420	350	17,00	061480	1.691,00

Calentador de agua instantáneo

Instant water heater
Chauffe-eau instantané



Características principales:

Diseñado para proporcionar agua caliente a un solo lavamanos. Calienta el agua mediante su paso por un serpentín eléctrico.

Temperatura de salida del agua de 35° a 50°
Leaving water temperature 35° - 50°
Température de sortie d'eau 35° - 50°

Main characteristics:

It is designed to provide instantaneous hot water to one hand washbasin, by means of an electric coil.

Caractéristiques principales:

Il est conçu pour fournir de l'eau chaude instantanée au lave-main, au moyen d'une bobine électrique

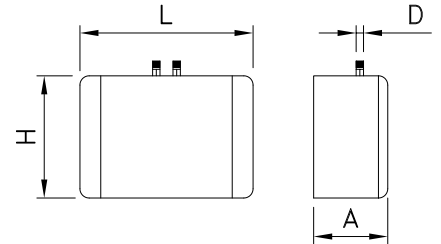

L	A	H	D			Potencia Power Puissance	Tensión Voltage Tension	Frecuencia Frequency Fréquence			€
165	70	200	3/8"	50°C	2,0	3.500 W	230 V	50/60 Hz.	1,10	461456	265,00









Repuestos y accesorios para lavamanos

Spare parts for hand wash basins
Pièces de rechange pour lave-mains

	Descripción Description Description	Modelo Model Model			€
	Pedal de un agua M-M de 1/2" M-M 1/2" single inlet water pedal Pédale à une eau M-M d'1/2"		425	460602	58,00
	Pedal mezclador de agua fría y caliente M-M-M de 1/2" M-M-M 1/2" hot and cold-water mixer pedal Pédale mélangeuse eau froide et eau chaude M-M-M d'1/2"		770	460604	113,00
	Pulsador no temporizado M-M de 1/2" M-M 1/2" self-closing momentary push button Bouton-poussoir non temporisé M-M d'1/2"		390	460404	48,00
	Pulsador inoxidable temporizado M-M de 1/2" Stainless steel push button - timer valve M-M de 1/2" Bouton poussoir inox temporisé 1/2" M-M		390	460432	60,00
	Kit de juntas para pulsador no temporizado 460404 Gasket kit for push button not timer 460404 Kit de joints pour bouton-poussoir non temporisé 460404		5	460450	6,00
	Grifo de palanca un agua M-M de 1/2" M-M 1/2" knee-operated lever Robinet à levier M-M d'1/2"		1.350	463802	115,00













Repuestos y accesorios para lavamanos

Spare parts for hand wash basins
Pièces de rechange pour lave-mains

	Descripción Description Description	Modelo Model Model				
	Caño fijo 1/2" Fixed spout 1/2" Jet fixe 1/2"	Fijo Fixed Fix	420	461002	55,00	
	Caño giratorio 1/2" Rotating spout 1/2" Jet giratoire 1/2"	Giratorio Rotating Giratoire	250	461008	42,00	
	Caño giratorio extra bajo 1/2" Extra low rotating spout 1/2" Jet giratoire extra bas 1/2"	Giratorio Rotating Giratoire	280	461010	47,00	
	Grifo sobremesa electrónico Electronically-operated faucet, high spout Robinet électronique col de cygne haut	Fijo Fixed Fix	1.800	060804	135,00	
	Peto postizo para acoplar Detachable backsplash to be fitted to hand wash basin Dosseret amovible pour accopler au lave-mains	350x400 mm	1.120	060608	27,00	
		450x400 mm	1.450	060602	28,00	
	Peto postizo con taladros Backsplash with drills for hand washbasin Dosseret perforé pour lave-mains		450x400 mm	1.450	060606	29,00
	Peto postizo de esquina Corner backsplash Dosseret d'angle		350+350x400 mm	2.300	060612	55,00
	Peto postizo lateral reversible anti salpicaduras Detachable and reversible sidesplash Dosseret postiche latéral réversible anti-éclaboussures			415	060630	25,00
	Peto postizo envolvente anti salpicaduras Detachable anti-splash screen Dosseret postiche enveloppant anti-éclaboussures	350 mm	1.270	060632	29,00	
		450 mm	1.600	060634	35,00	











Repuestos y accesorios para lavamanos

Spare parts for hand wash basins
Pièces de rechange pour lave-mains

	Descripción Description Description	Modelo Model Model			
	Papelera modelo Design (lavamanos integral mural) Design model wastepaper bin (wall mounted integral hand wash basins) Corbeille à papier modèle Design (lavemains intégral mural)				
					
		2.300	080608	77,00	
	Papelera-dispensador de papel Paper bags dispenser Distributeur de sacs en papier				
		2.000	080424	64,00	
	Papelera Wastepaper bin Corbeille à papiers				
		2.200	080602	59,00	
	Latiguillos flexibles en malla de acero inoxidable H-H de 1/2" H-H 1/2" stainless-steel flexible hoses Flexibles en maille d'acier inoxydable H-H d'1/2"	400 mm	100	461202	5,25
		600 mm	120	461206	6,30
		900 mm	200	461212	8,40
		1.200 mm	240	461214	7,88
		1.500 mm	345	461216	9,45
	Válvula con rebosadero para lavamanos de 450x450 mm Drain valve with overflow for 450x450 mm hand wash basins. Valvule de drainage avec déversoir pour lave-mains de 450x450 mm				
		145	454202	9,00	
	Válvula de PVC con rebosadero, acabado cromado 1 1/2" Drain valve in PVC with overflow, chrome finished 1 1/2" Valvule de drainage avec déversoir en PVC, finition chromé 1 1/2"				
		150	454205	43,00	
	Rebosadero para lavamanos 061402, 061404 y 061448 Overflow for 061402, 061404 and 061448 hand wash basins Déversoir pour lave-mains 061402, 061404 et 061448				
		2	454206	6,30	
	Desagüe flexible para lavamanos autónomo 1 1/2" Flexible drain hose for autonomous wash basin 1 1/2" Tuyau de drainage flexible pour lave main autonome 1 1/2"				
		125	454260	5,25	
	Sifón de desagüe para lavamanos 1 1/2" U-bended drainpipe for hand wash basins 1 1/2" Siphon de drainage pour lave-mains 1 1/2"				
		169	454402	6,00	









Repuestos y accesorios para lavamanos

Spare parts for hand wash basins
Pièces de rechange pour lave-mains

	Descripción Description Description			
	Sifón de PVC acabado cromado 1 1/2" U-bended drainpipe in PVC, chrome finished 1 1/2" Siphon en PVC, finition chromé 1 1/2"	170	454408	36,00
	Sifón de latón cromado 1 1/2" U-bended drainpipe in chrome brass 1 1/2" Siphon en laiton chromé 1 1/2"	1.400	454404	80,00
	Bidón de 10 lts para lavamanos autónomo 10 litres water container for portable hand washbasins Bidon d'eau de 10 litres pour lave main autonome	360	461430	15,00
	Bidón apilable blanco 15L para fregadero autónomo White stackable Jerrycan 15L for portable sinks Bidon empilable blanc 15L pour plonge autonome	550	461428	20,00
	Bidón apilable translúcido 20 lts para fregadero autónomo 20 litres water container for portable sinks Bidon d'eau de 20 litres pour Plonge inox autonome	360	461426	25,00
	Bidón apilable blanco 25L para fregadero autónomo White stackable Jerrycan 25L for portable sinks Bidon empilable blanc 25L pour plonge autonome	1.200	461429	27,00
	Goma elástica para la sujeción de bolsas de basura en lavamanos Elastic strap for hand wash basins Tendeurs élastiques pour lave-mains	125	464406	3,50
	Rueda de plástico ø50x18 mm para lavamanos autónomo Plastic wheel ø50x18 mm for autonomous wash basin Roulette en plastic ø50x18 mm pour lave main autonome	25	485020	4,30
	Tapón cubre agujeros ø42mm Hole cover cap ø42mm Bouchon couvre trou ø42mm	16	454602	3,00
	Hacer agujero en fregadero o lavamanos Drill hole to sink Faire trou à plonge	056802		33,00

Repuestos y accesorios para lavamanos

Spare parts for hand wash basins
Pièces de rechange pour lave-mains

	Descripción Description Description			
	Válvula mezcladora termostática M-H-M de 1/2" M-H-M 1/2" thermostatic mixing valve Valve mélangeuse thermostatique M-H-M d'1/2"	620	461402	97,00
	Mezclador antiretorno M-H-M 1/2" M-F-M 1/2" no-return mixing valve Valve antiretour mélangeuse M-H-M d'1/2"	150	461604	26,25
	Válvula de esfera H-H de 1/2" F-F 1/2" valve Valve H-H d'1/2"	140	461404	10,00
	Válvula antiretorno H-H de 1/2" F-F 1/2" non-return valve Valve antiretour H-H d'1/2"	140	462202	8,40
	"T" mezcladora M-H-M de 1/2" M-F-M 1/2" "T" mixer "T" mélangeur M-H-M d'1/2"	80	461602	7,00
	Codo a 90° M-H de 1/2" M-F 1/2" 90° angle Coude à 90° M-H d'1/2"	80	461802	3,15
	Unión M-M de 1/2" M-M 1/2" union Jonction M-M d'1/2"	20	462002	2,25
	Dosificador de jabón encastrable 600 ml. Stainless steel soap dispenser to be embedded 600 ml. Doseur de savon en acier inoxydable pour adosser 600 ml.	580	460218	79,00



FUENTES DE AGUA

DRINKING FOUNTAINS
FONTAINE D'EAU

NOVEDADES

NEWS
NOUVEAUTÉS



207



207



210



211



212



214





Fuentes de agua fría, caliente y del tiempo Futura

Drinking fountains Futura, for cold, hot and room temperature water
Fontaines d'eau froide, chaude et à température ambiante Futura



Características principales:

La fuente de agua fría más compacta del mercado. Especial para espacios reducidos. Máxima ergonomía. Dispensador de vasos. Dispensador para llenar botellas y recipientes de grandes dimensiones. Dotada de filtro de agua de carbón activado 3M de 0,5 micras de serie. Certificado NSF y EN 1935/2004. Duración 4.000 litros aproximadamente. No lleva válvula de flotador para mayor higiene. Tecnología Silver para maximizar la higiene. Control del nivel de frío. Termostato interno. Funcionamiento súper silencioso. Compresor de 1/15 HP modo ahorro de energía. Soporta temperaturas ambiente de hasta 43°C. Entrada con conexión rápida de agua de 1/4". Panel de acero inoxidable fácilmente desmontable para facilitar el mantenimiento. Calentador de agua de 2.000 W. Tanque suplementario de agua caliente de 0,8 litros y 45 tazas/hora de capacidad y fabricado en acero inoxidable. Temperatura controlada mediante microprocesador para priorizar el ahorro de energía. Máxima temperatura 97°C. Fabricada en la Unión Europea. Los filtros se deberán cambiar cada 4.000 lts. o 6 meses. Lo que antes se dé.

*Nota: La alimentación de agua de la fuente debe ser agua apta para el consumo humano (agua potable). En ningún caso el equipo adaptará o convertirá agua al consumo humano que no lo sea, ni antes ni después de pasar por el equipo.

Main characteristics:

The smallest cold water drinking fountain, specially for reduced spaces. Superior ergonomics. Cup dispenser. Dispenser for filling bottles and large containers. Provided with 0.5 microns activated carbon water filter 3M for 4.000 liters approx. NSF and EN 1935/2004 certified. Without float valve for a maximum hygiene. Silver technology to maximize the hygiene. Cooling controlled. Internal thermostat. Smooth silent running. Energy saving compressor 1/15 HP. Resistant to environmental temperatures up to 43°C. Quick connector 1/4" for water inlet. Stainless steel panel easy to remove to facilitate the maintenance. Water heater 2.000 W. Additional container of 0,8 liters for hot water with capacity for 45 cups per hour. Made of stainless steel. Temperature controlled by microprocessor to prioritize the energy saving. Maximum temperature 97°C. Made in the European Union. The filters must be changed every 4.000 liters or 6 months. Whatever earlier comes.

*Comments: the water supply must be suitable for human consumption (drinking water). Under no circumstance this device will convert or adapt non drinking water to suitable for human consumption, before or after bypassing through the device.

Caractéristiques principales:

La fontaine d'eau froide de taille la plus réduite du marché. Spécialement conçu pour les espaces réduits. Ergonomie maximum. Distributeur de verres. Distributeur pour remplir bouteilles et récipients de grandes dimensions. Possède un filtre à charbon actif 3M de 0,5 microns de série. Certificat NSF et EN 1935/2004. Durée 4.000 litres environ. Ne contient pas de valve de flotteur pour une meilleure hygiène. Technologie Silver pour un maximum d'hygiène. Control du niveau de froid. Thermostat interne. Fonctionnement super silencieux. Compresseur de 1/15 HP en mode économie d'énergie. Supporte des températures ambiantes jusqu'à 43°C. Entrée avec connexion rapide d'eau de 1/4". Panneau en acier inoxydable facilement démontable pour faciliter la maintenance. Chauffe eau de 2.000 W. Réservoir supplémentaire d'eau chaude de 0,8 litres et 45 tasses par heures de capacité. Fabriqué en acier inoxydable. Température contrôlée à travers un microprocesseur pour privilégier l'économie d'énergie. Température maximum 97°C. Fabriquées dans l'Union Européenne. Les filtres doivent se changer chaque 4.000 lts ou tous les 6 mois. Des deux, la première situation qui se produise.

* Note : l'alimentation d'eau de la fontaine doit être de l'eau appropriée à la consommation humaine (eau potable). En aucun cas le matériel s'adaptera ou convertira en eaux pour la consommation humaine, des eaux qui ne le sont pas, ni avant, ni après leur passage par le matériel.

°C de entrada de agua	Refrigeración	°C Salida de agua	
°C inlet water	Refrigeration	°C Output	
°C eau d'entrée	Réfrigération	Water	
		°C Eau de sortie	
25 °C	-4 °C	21 °C	33
25 °C	-14 °C	11 °C	9

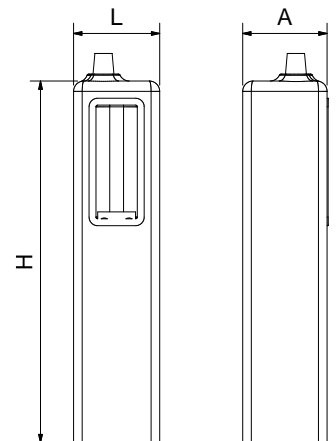

L	A	H	Potencia Power Puissance	Tensión Voltage Tension	Frecuencia Frequency Fréquence	Kg	Barcode	€
---	---	---	--------------------------------	-------------------------------	--------------------------------------	----	---------	---



250 175 1.060 50 W 220 V 50 Hz. 18 464204 899,00

Fuente de agua fría Cold+ mural
Cold+ wall mounted water drinking fountain
Fontaine d'eau fraîche Cold+ murale



Características principales:

Dotada de grifo llena-jarras.
Control del nivel de frío. Termostato interno.
Entrada de agua de 1/4".
Panel de acero inoxidable fácilmente desmontable para el mantenimiento. Fabricada en la Unión Europea.



Main characteristics:

Provided of swan neck tap.
Temperature level controlled by internal thermostat.
Water inlet 1/4".
Stainless steel front pannel, easily detachable to facilitate the maintenance.
Made in EU.

Caractéristiques principales:

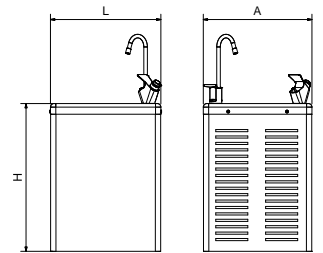
Avec robinet pour remplir les pichets.
Control du niveau du froid. Thermostat interne.
Entrée d'eau 1/4".
Panneau en acier inox facilement démontable pour faciliter la maintenance.
Fabriquée en U.E.



L	A	H		Potencia Power Puissance	Tensión Voltage Tension	Frecuencia Frequency Fréquence			€
320	320	600	28	140 W	220 V	50 Hz.	17,0	464208	957,00



Fuente de agua fría Cold+
Cold+ water drinking fountains
Fontaine d'eau fraîche Cold+



Características principales:

Dotada de grifo llena-jarras.
Control del nivel de frío. Termostato interno.
Entrada de agua de 1/2".
Panel de acero inoxidable fácilmente desmontable para el mantenimiento. Fabricada en la Unión Europea.



Main characteristics:

Provided of swan neck tap.
Temperature level controlled by internal thermostat.
Water inlet 1/2".
Stainless steel front pannel, easily detachable to facilitate the maintenance.
Made in EU.

Caractéristiques principales:

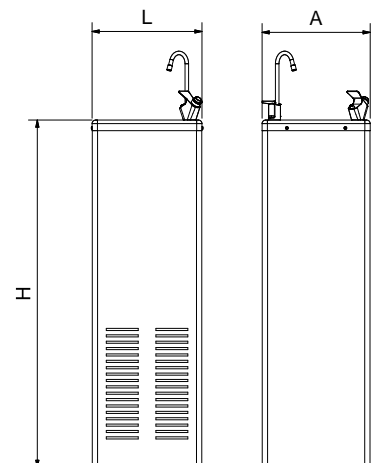
Avec robinet pour remplir les pichets.
Control du niveau du froid. Thermostat interne.
Entrée d'eau 1/2".
Panneau en acier inox facilement démontable pour faciliter la maintenance.
Fabriquée en U.E.



L	A	H		Potencia Power Puissance	Tensión Voltage Tension	Frecuencia Frequency Fréquence			€
320	320	1.000	24	240 W	220 V	50 Hz.	25,0	464206	1.041,00



Fuente de agua fría de columna

Cold water drinking column fountain
Fontaine colonne d'eau fraîche



Novedad
new
nouveau

Características principales:

Dotada de grifo llena-jarras.
Control del nivel de frío.
Termostato digital.
12 l/h.

Main characteristics:
Provided of swan neck tap.
Temperature level controlled.
Digital thermostat.
12 l/h.

Caractéristiques principales:
Avec robinet pour remplir les pichets.
Control du niveau du froid.
Thermostat digital.
12 l/h.

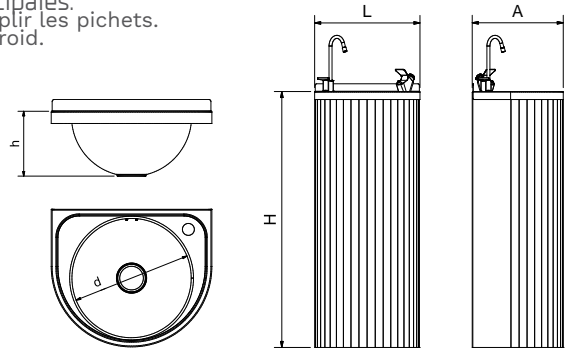

L	A	H	d	h	Potencia Power Puissance	Tensión Voltage Tension	Frecuencia Frequency Fréquence	Kg	Barcode	€
350	300	850	260	115	105 W	220-240 V	50 Hz.	17,0	064280	803,00

Fuente de agua fría de columna con grifo electrónico sin contacto

Cold water drinking column fountain with contactless electronic faucet
Fontaine colonne d'eau fraîche avec robinet électronique sans contact



Novedad
new
nouveau

Gracias a su grifo electrónico, su accionamiento se realiza sin contacto, lo cual ayudará a prevenir la contaminación cruzada.

Además, el grifo va temporizado por lo que los usuarios podrán utilizar la fuente con tranquilidad sin la necesidad de estar pulsando ningún botón.

Dotada de grifo llena-jarras.
Control del nivel de frío.
Termostato digital.
12 l/h.
Grifos electrónicos a pilas.

Thanks to its electronic battery-operated faucet (batteries not included), it will be activated hands-free, which will help to prevent cross contamination.

In addition, the faucet is timed and will switch off by itself, so that users can use the fountain in a carefree way.

Provided of swan neck tap.
Temperature level controlled.
Digital thermostat.
12 l/h.
Battery-operated electronic taps.

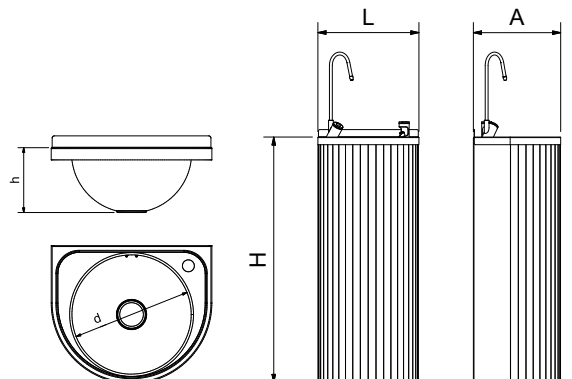

Grâce à son robinet électronique à pile (non inclus), son activation se fait sans contact, ce qui aidera à prévenir la contamination croisée.

De plus, le robinet est temporisé afin que les utilisateurs puissent utiliser la fontaine en toute tranquillité sans avoir besoin d'appuyer sur un bouton.

Avec robinet pour remplir les pichets.
Control du niveau du froid.
Thermostat digital.
12 l/h.
Robineets électroniques à piles.

L	A	H	d	h	Potencia Power Puissance	Tensión Voltage Tension	Frecuencia Frequency Fréquence	Kg	Barcode	€
350	300	850	260	115	105 W	220-240 V	50 Hz.	17,0	064282	1.212,00

Fuentes murales refrigeradas de agua fría Cold+ a pedal

Wall-mounted refrigerated drinking water fountains Cold+ with pedal

Fontaines murale réfrigérée d'eau froide Cold+ à pédale

955020201



955020601

955020501

Características

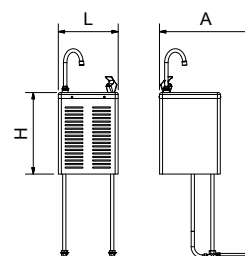
Characteristics
Caractéristiques



Tipo de accionamiento de grifo Tap operation Accionnement du robinnet	Pedal Pedal Pédale	Pedal Pedal Pédale	Manual Manual Manuel
Tipo de accionamiento de llenajarras Bottle filler operation Accionnement du robinet de remplissage	Pedal Pedal Pédale	Manual Manual Manuel	Pedal Pedal Pédale
Tipo de agua Type of water Type d'eau			
L	310 mm	310 mm	310 mm
A	485 mm	485 mm	485 mm
H	415 mm	415 mm	415 mm
Peso / Weight / Poids	19,00 Kg.	18,00 Kg.	18,00 Kg.
Potencia Power Puissance	125 W	125 W	125 W
Tensión Voltage Tension	220 V	220 V	220 V
Frecuencia Frequency Fréquence	50 Hz.	50 Hz.	50 Hz.
	1.231,00€	1.147,00€	1.141,00€

Fuentes refrigeradas de agua fría Cold+ a pedal

Free standing pedal operated refrigerated drinking fountains Cold+
Fontaines réfrigérée eau froide Cold + à pédale



955020101

955020301

955020401

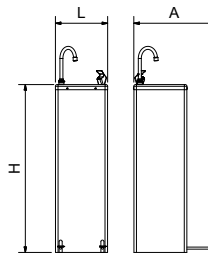
Características Characteristics Caractéristiques



Tipo de accionamiento de grifo Tap operation Accionnement du robinnet	Pedal Pedal Pédale	Pedal Pedal Pédale	Manual Manual Manuel
Tipo de accionamiento de llenajarras Bottle filler operation Accionnement du robinet de remplissage	Pedal Pedal Pédale	Manual Manual Manuel	Pedal Pedal Pédale
Tipo de agua Type of water Type d'eau			
L	320 mm	320 mm	320 mm
A	485 mm	485 mm	485 mm
H	1.000 mm	1.000 mm	1.000 mm
Peso / Weight / Poids	27,00 Kg.	26,00 Kg.	26,00 Kg.
Potencia Power Puissance	240 W	240 W	240 W
Tensión Voltage Tension	220 V	220 V	220 V
Frecuencia Frequency Fréquence	50 Hz.	50 Hz.	50 Hz.
	1.315,00€	1.231,00€	1.225,00€



Fuentes de columna sin refrigeración

Column fountains - Unrefrigerated
Fontaines colonne - Sans réfrigération



064206

064212

064202

Características Characteristics Caractéristiques

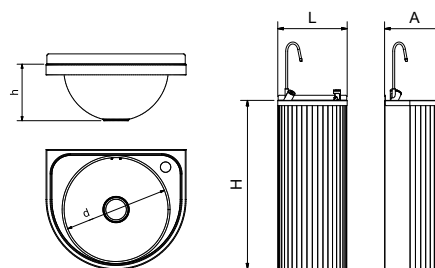

Tipo de accionamiento de grifo Tap operation Accionnement du robinnet	Manual Manual Manuel	Pedal Pedal Pédale	Sensor sin contacto Non-contact sensor Capteur sans contact
Tipo de accionamiento de llenajarras Bottle filler operation Accionnement du robinet de remplissage	Manual Manual Manuel	Manual Manual Manuel	Sensor sin contacto Non-contact sensor Capteur sans contact
L	350 mm	320 mm	320 mm
A	300 mm	320 mm	320 mm
H	850 mm	1.000 mm	1.000 mm
d	260 mm	260 mm	260 mm
h	115 mm	115 mm	115 mm
Peso / Weight / Poids	7,00 Kg.	7,30 Kg.	7,40 Kg.
Pilas Batteries Piles	-----	-----	4 x CR123
	278,00€	368,00€	615,00€

Fuentes murales sin refrigeración
Wall-mounted fountains - Unrefrigerated
Fontaines mural - Sans réfrigération



064204

064210

064208

064203

Características
Characteristics
Caractéristiques

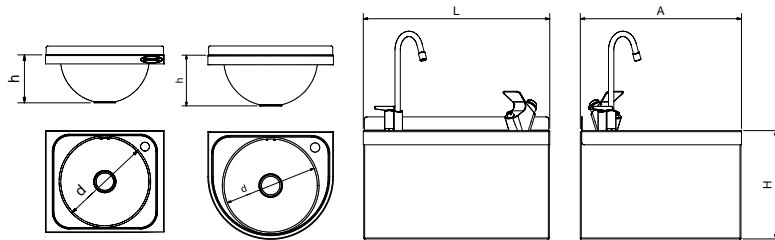

Tipo de accionamiento de grifo Tap operation Accionnement du robinnet	Manual Manual Manuel	Manual Manual Manuel	Manual Manual Manuel	Sensor sin contacto Non-contact sensor Capteur sans contact
Tipo de accionamiento de llenajarras Bottle filler operation Accionnement du robinet de remplissage	Manual Manual Manuel	Manual Manual Manuel	Manual Manual Manuel	Sensor sin contacto Non-contact sensor Capteur sans contact
L	350 mm	350 mm	350 mm	350 mm
A	300 mm	350 mm	300 mm	300 mm
H	200 mm	205 mm	200 mm	200 mm
d	260 mm	260 mm	260 mm	260 mm
h	115 mm	115 mm	115 mm	115 mm
Peso / Weight / Poids	2,08 Kg.	3,00 Kg.	6,00 Kg.	6,00 Kg.
Pilas Batteries Piles	-----	-----	-----	4 x CR123

177,00€

335,00€

196,00€

495,00€

Enfriador de agua

Water cooler
Refrigerateur d'eau

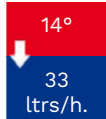

Características:

Ideal para instalar agua fría en fregaderos, lavamanos, fuentes, etc.
Tecnología para mejorar la higiene.
Termostato para regular la temperatura del agua.
Ahorro de energía gracias a su compresor de 1/4 Hp.
CE
Fabricado en la unión Europea.
Envoltorio de acero pintado.
Entrada y salida de agua de 1/2"

Caractéristiques:

Ideal pour installer de l'eau froide sur des éviers, lavemains, fontaines, etc.
Technologie pour améliorer l'hygiène.
Thermostat pour régler la température de l'eau.
Economie d'énergie grâce à son compresseur de 1/4 Hp.
CE
Fabriquée en Union Européenne
Entrée et sortie d'eau grâce à une connexion 1/2".
Acier peint.

Characteristics:

Ideal for incorporating cool water in sink units, hand washbasins, drinking fountains, etc.
Technology for a better hygiene
Temperature adjustment by thermostat
Energy saving through compressor - 1/4 Hp
CE
Made in UE
Inlet and outlet connectors 1/2".
Painted steel.

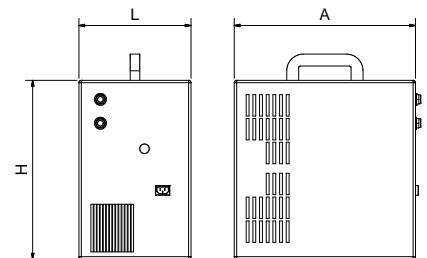

L	A	H	D	Potencia Power Puissance	Tensión Voltage Tension	Frecuencia Frequency Fréquence	Kg	Barcode	€
300	400	470	1/2"	230 W	220-240 V	50 Hz.	18,0	461460	810,00

Sistema filtrador de agua

Water filter system
Système filtrant de l'eau

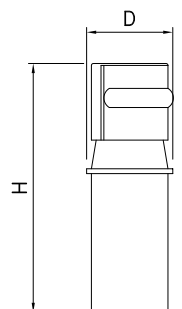

D	H	Kg	Barcode	€
80	290	1,00	064270	168,00

Sistema filtrador de agua con grifo llenajarras

Water filter system with bottle filler tap

Système filtrant de l'eau avec robinet pour remplir des pichets

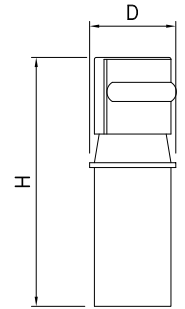

D	H	Kg	Barcode	€
80	290	1,30	064272	176,00



Sistema filtrador de agua con caño





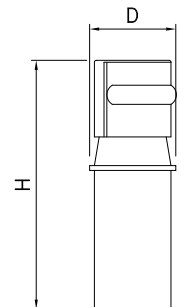





Water filter system with spout

Système filtrant de l'eau avec bec de cygne



D	H	Kg	Barcode	€
80	290	1,25	064274	192,00

Accesorios para fuentes M 3/8"
 Spare parts for water fountains M 3/8"
 Pièces de rechange pour fontaines d'eau M 3/8"

	Descripción Description Description	Gr	Barcode	€
	Grifo para fuente de agua sin pulsador Tap for drinking fountain without push-button Robinet pour fontaine sans bouton-poussoir	115	464248	37,00
	Grifo pulsador para fuente Push-button tap for fountain Robinet poussoir pour fontaine	125	464250	26,00
	Grifo electrónico inoxidable a pilas para fuente de agua 1/2" Electronic battery-powered faucet 1/2" in stainless steel for drinking fountain Robinet électronique à pile en acier inoxydable pour fontaine à eau 1/2"	460	464258	234,00
	Grifo llena-jarras Bottle filler Robinet pour remplir pots	130	464252	24,00
	Grifo llenajarras electrónico acero inoxidable para fuente de agua Stainless steel electronic bottle-filler tap for drinking fountain Robinet de remplissage de pichet électronique en acier inoxydable pour fontaine à eau	310	464254	265,00
	Filtro profesional de agua Brita Brita professional water filter Filtre à eau professionnel Brita	500	464224	92,00
	Filtro Bestmax para Futura fría y caliente Bestmax filter for Futura hot and cold water Filtre Bestmax pour Fontaine Futura froid et chaud	1.000	464220	104,00
	Filtro agua fría para Futura, Cold+ y Enfriador de agua Filter cold water for Futura, Cold+ and Water cooler Filtre eau froide pour fontaine Futura, Cold+ et Refroidisseur d'eau	230	464222	79,00
	Cabezal para filtro 3M y CARBA (Futura fría, Cold+ y Enfriador de agua) Head for filter 3M and CARBA (Futura cold, Cold+ and Water cooler) Tête pour filtre 3M et CARBA (Fontaine Futura froid, Cold+ et Refroidisseur d'eau)	100	464226	97,00
	Cabezal para filtro Bestmax (Futura fría y caliente) Head for filter Bestmax (Futura hot and cold water) Tête pour filtre Bestmax (Fontaine Futura froid et chaud)	1.500	464228	97,00



FREGADEROS

SINKS
ÉVIERS

NOVEDADES

NEWS
NOUVEAUTÉS



220



231

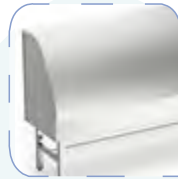

232



234



234



235



238



238



238



238



239



239



239



239



239

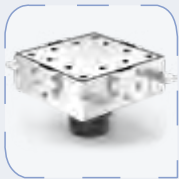

240



240



Características de fabricación:

Fregaderos

La amplia gama de fregaderos Fricosmos está concebida para adaptarse al máximo a las necesidades industriales, por lo que en nuestro catálogo encontrarán fregaderos colgantes, con soporte, con puertas, etc.

Totalmente fabricados en acero inoxidable, cuentan con bastidores de refuerzo bajo la encimera y entrepaño.

Estructura totalmente soldada que garantiza una mayor solidez frente a otros fregaderos con soportes desmontables. Patas construidas en tubo de 40x40 mm. Los modelos sin entrepaño llevan bastidor inferior de refuerzo.

Soporte desplazado en su parte trasera para salvar la curva sanitaria del suelo.

Pies regulables para favorecer la estabilidad, ya que se adaptan a cualquier desnivel del suelo.

Válvula de desagüe con tapón y rebosadero en modelos de fondo 500 mm. Los modelos industriales (fondo 600 y 700 mm.) se suministran con tubo rebosadero y válvula de desagüe.

Opcionalmente se pueden instalar los siguientes accesorios:



Taladro para acoplar grifo	201
Cajones	492
Ruedas	496
Válvula de descarga rápida	235
Esterilizador de cuchillos	370
Cubetas Gastronorm	435

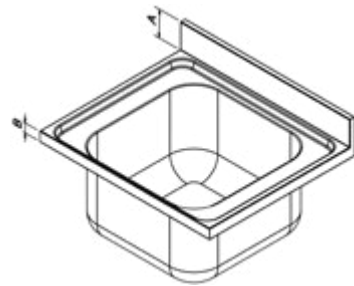

	A	B
Serie 500 Model 500 Série 500	30	30
Serie 550 Model 550 Série 550	100	60
Serie 600 y 700 Model 600 & 700 Série 600 et 700	100	60

Detalle de tubo rebosadero (Fregaderos de ancho 600 y 700 mm)
Overflow detail. (600 y 700 mm sinks)
Détail de tube-déversoir (profondeur 600 et 700 mm)

Manufacturing characteristics:

Sink units

The wide range of sinks Fricosmos is conceived to fit in to the best industrial needs: wall-mounted sinks, with support, sliding or hinged doors...

Wholly made of stainless steel, they are fitted with undercounter and undershelf reinforcement frames.

Totally welded frame that guarantees a higher solidity in comparison to other detachable supports. Legs made of tube 40x40 mm. Models without shelf are reinforced with lower frame.

Frame support set back from the edge of the top to overcome the sanitary rounded corners.

Adjustable feet, for a better stability, since they can be adjusted to any floor unevenness.

Drain valve with plug and overflow in sink units of 500 mm depth. Industrial units (depth 600 and 700 mm.) are provided with pipe-overflow and drain valve.

Optionally, the following accessories can be installed:



Hole to couple tap	201
Drawers	492
Wheels	496
Quick drain valve	235
Knife-holder disinfectant	370
Gastronorm containers	435

Detalle de rueda de acero inoxidable con freno acoplada a pata de fregadero.

Detail of wheel in stainless steel with brake fixed to leg.

Détail de roue en acier inoxydable avec frein installé dans pied.



Detalle de pata con pie regulable.
Detail of adjustable feet.
Détail de pie réglable.

Caractéristiques de fabrication:

Éviers

L'ample gamme d'éviers Fricosmos est conçue pour sa meilleure adaptation aux besoins industriels. Éviers suspendus, avec support, avec portes à deux battants, coulissantes...

Fabriqués entièrement en acier inoxydable, avec renfort sous l'étagère et tablette du dessous.

Châssis totalement soudé. Il permet d'achever plus de solidité par rapport à d'autres éviers avec supports démontables. Pieds construits en tube de 40x40 mm. Les modèles sans tablette-rayon ont du châssis inférieur de renforcement.

Support déplacé dans la partie postérieure pour permettre l'installation des conduits d'eau. En plus il est dessiné pour s'adapter parfaitement à la courbure sanitaire du sol.

Pieds réglables pour favoriser sa stabilité, puisqu'ils s'adaptent à n'importe quel sol.

Écoulement avec tampon et déversoir dans éviers avec 500 mm de profondeur. Les éviers industriels (profondeur 600 et 700 mm) sont fabriqués avec tube-déversoir et écoulement.

On peut installer les suivantes accessoires optionnels:



Trou pour accoupler un robinet	201
Tiroirs	492
Rouelles	496
Valve de rapide drainage	235
Porte-couteaux désinfecteur	370
Bacs Gastronorm	435

Fregaderos para soldar

Sink units to weld
Eviders à souder



Características de fabricación:

Fabricados en acero inoxidable. Las cubetas son de 1 mm de espesor y están acabadas en satinado scotch-brite. Válvula de desagüe con tapón y rebosadero en modelos redondos, los modelos industriales de 250, 300 y 350 mm se suministran con válvula de desagüe (sin rebosadero), tubo de rebosadero y tapón.

Manufacturing characteristics:

Made in stainless steel. Tanks have 1 mm. thick and scotch brite matt finish. Drain valve with plug and overflow in rounded. Industrial models of 250, 300 and 350 mm. depth are provided with drain valve (without overflow), tube of overflow and plug.

Caractéristiques de fabrication:

Fabriqués en acier inoxydable. Les bacs ont 1 mm d'épaisseur avec finition satiné scotch brite. Valvule d'écoulement avec bonde et déversoir dans models ronds Les models industriels de 250, 300 et 350 mm son pourvus avec valvule d'écoulement (sans déversoir).

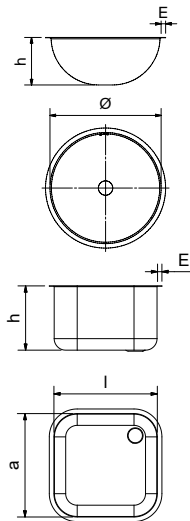

Ø	l	a	h	E	Kg	Barcode	€
260			115	15	0,70	350624	40,00
390			150	20	1,40	350620	65,00
	370	340	145	20	2,60	350648	111,00
	400	400	250	20	3,71	454018	100,00
	400	400	300	20	4,10	454020	110,00
	500	500	300	20	5,40	454039	145,00
	500	500	350	20	5,63	454041	215,00
	600	450	300	20	5,45	454042	170,00
	600	450	300	20	5,45	454044	170,00
	600	450	350	20	6,11	454045	229,00
	600	450	350	20	6,11	454054	229,00
	600	500	300	20	5,95	454046	180,00
	600	500	300	20	5,95	454048	197,00
	600	500	350	20	6,51	454050	183,00
	600	500	350	20	6,51	454052	183,00
	800	420	350	20	9,51	454004	465,00
	800	420	350	20	9,51	454006	465,00
	1.060	420	350	20	10,51	454008	530,00
	1.060	420	350	20	10,51	454010	530,00

Fregaderos para encastrar

Built-in sink series
Eviders modèle à intégrer

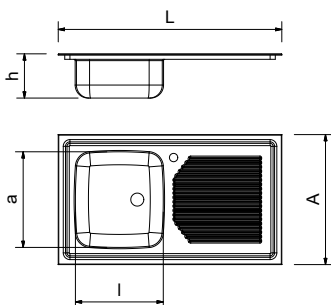

Reversible
Reversible
Réversible



L	A	l	a	h	Kg	Barcode	€
900	510	344	377	145	3,12	453202	115,00
1.160	500	330	360	160	3,50	453206	151,50
1.160	500	330	360	160	3,50	453208	151,50

Fregaderos

Sink units
Éviers

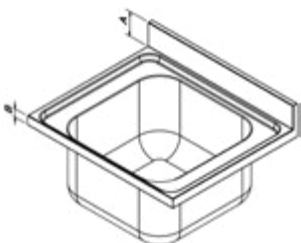

	A	B
Serie 500 Model 500 Série 500	30	30
Serie 550 Model 550 Série 550	100	60
Serie 600 y 700 Model 600 & 700 Série 600 et 700	100	60



L	A	l	a	h	Kg	Barcode	€
450	450	370	340	170	1,85	450602	80,00
450	500	370	340	170	2,10	450604	85,00
600	500	500	400	150	2,95	450606	94,00
600	600	500	500	300	7,50	452200	230,00
700	600	500	400	250	8,35	452202	255,00
700	700	500	500	300	9,00	452602	285,00
800	600	500	400	250	9,00	452204	275,00
800	700	600	500	300	10,00	452604	320,00
1.000	600	860	420	350	14,50	452228	575,00
1.000	700	860	495	375	15,50	452628	559,00
1.200	600	1.060	420	350	16,50	452230	625,00
1.200	700	1.060	500	375	17,50	452630	606,00
1.500	600	1.160	420	600	19,50	453804	912,00
1.500	700	1.160	490	600	20,50	453806	922,00
2.000	600	800	420	600	24,50	453808	1.577,00
2.000	700	800	495	600	25,50	453810	1.600,00
1.300	700	800	495	370	14,00	453602	624,00
1.600	700	960	500	375	18,00	453606	640,00
1.300	700	800	495	370	14,00	453604	624,00
1.600	700	960	500	375	18,00	453608	640,00
800	500	370	340	120	3,10	450616	101,00
1.000	500	420	350	150	3,80	450628	120,00
1.000	550	340	340	200	8,50	452002	304,00
1.000	600	500	400	250	9,00	452206	300,00
1.000	700	500	500	300	10,00	452606	425,00
1.200	600	500	400	250	11,65	452210	304,00
1.200	700	400	500	250	12,65	452610	345,00
1.300	600	500	500	300	12,65	452214	360,00
1.300	700	500	500	300	12,50	452614	340,00
1.400	600	500	400	250	13,00	452218	330,00
1.400	700	600	500	300	14,00	452618	360,00
800	500	370	340	120	3,10	450618	101,00
1.000	500	420	350	150	3,80	450630	120,00
1.000	550	340	340	200	8,50	452004	304,00
1.000	600	500	400	250	9,00	452208	300,00
1.000	700	500	500	300	10,00	452608	425,00
1.200	600	500	400	250	11,65	452212	304,00
1.200	700	400	500	250	12,65	452612	345,00
1.300	600	500	500	300	12,65	452216	360,00
1.300	700	500	500	300	12,50	452616	340,00
1.400	600	500	400	250	13,00	452220	330,00
1.400	700	600	500	300	14,00	452620	360,00

Fregaderos
Sink units
Éviers

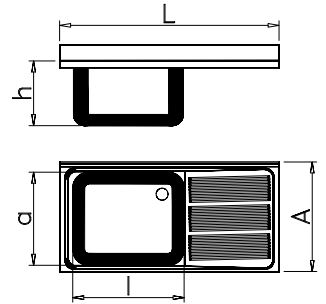

L	A	l	a	h	Kg	Barcode	€
800	500	340	370	150	3,80	450610	158,50
1.000	600	400	400	250	13,00	452222	429,00
1.000	700	400	500	250	14,00	452622	558,00
1.200	600	500	400	250	14,00	452224	477,00
1.200	700	500	500	300	15,00	452624	500,00
1.400	600	500	400	250	18,00	452226	475,00
1.400	700	600	500	300	19,00	452626	539,00
1.200	500	340	370	150	4,85	450636	191,50
1.400	550	400	400	250	14,50	452006	450,00
1.400	600	400	400	250	15,50	452232	442,00
1.400	700	400	500	250	16,50	452632	420,00
1.600	600	400	400	250	18,00	452246	460,00
1.600	700	400	500	250	19,00	452646	592,00
2.000	600	500	400	250	22,50	452240	494,00
2.000	700	600	500	300	23,50	452640	590,00
1.200	500	340	370	150	4,85	450638	191,50
1.400	550	400	400	250	14,50	452008	450,00
1.400	600	400	400	250	15,50	452234	442,00
1.400	700	400	500	250	16,50	452634	420,00
1.600	600	400	400	250	18,00	452248	460,00
1.600	700	400	500	250	19,00	452648	592,00
2.000	600	500	400	250	22,50	452242	494,00
2.000	700	600	500	300	23,50	452642	590,00
2.000	600	400	400	250	22,50	452244	494,00
2.000	700	400	500	250	23,50	452644	525,00
1.800	600	500	400	250	23,00	452250	913,00
1.800	700	400	500	300	25,00	452650	720,00



Escurridor de platos y vasos en acero inoxidable

Stainless steel drainer for glasses and dishes
Égouttoir en acier inoxydable pour assiettes et verres



Novedad
New
Bulky

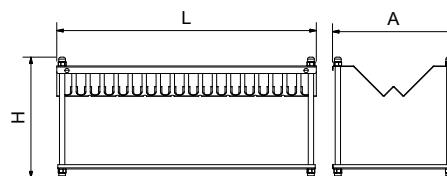

L	A	H				€
484	228	225	18	1,78	051602	48,00
955	228	225	36	3,25	051604	75,00

Escurridor mural para utensilios de cocina

Wall drainer for kitchen utensils
Égouttoir mural pour ustensiles de cuisine



Diseñado para ser colgado encima de cualquier fregadero. Los ganchos laterales permiten colgar utensilios grandes, mientras que el espacio interior nos permite colocar cualquier tipo de elemento para su escurrido.

Designed to be hung above any sink. The side hooks allow you to hang large utensils, while the internal space allows us to place any type of element for draining.



Conçu pour être suspendu au-dessus de n'importe quel évier. Les crochets latéraux permettent d'accrocher de grands ustensiles, tandis que l'espace intérieur nous permet de placer tout type d'élément pour égoutter.

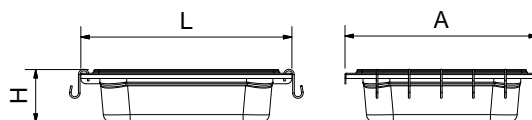

L	I	H				€
400	365	100	10	2,4	042602	50,00

Incluye 10 ganchos.
10 hook Includes.
Comprend 10 crochets.

Fregaderos para lavavasos y lavaplatos

Sink units for dishwashers

Éviers pour lave-vaisselles



Características de fabricación:

Fregaderos diseñados para alojar lavavasos o lavaplatos bajo el escurridor.

Fabricados en acero inoxidable.

Pies regulables para una mejor adaptación a la altura de la máquina.

Entrepañeo en su base para un mejor aprovechamiento del espacio, pues permite la colocación de cestas y objetos.



Detalle de instalación.
Installation example.
Exemple d'installation.

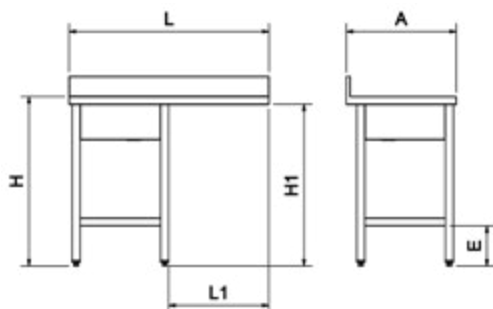

Caractéristiques de fabrication:

Éviers dessinés pour loger lave-vaisselles dessus l'égouttoir.

Fabriqué en acier inoxydable.

Pieds réglables pour achever une meilleure adaptation des machines.

Châssis avec tablette-rayon pour profiter l'espace le mieux, puisqu'il permet de loger des objets.

Manufacturing characteristics:









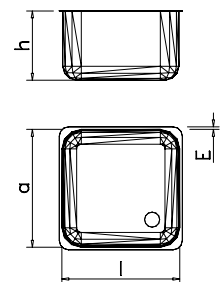







Sink units designed to lodge dishwashers under the drain board.

Made of stainless steel.

Adjustable feet in order to get a better adaptation of the machinery.

Frame with shelf for a better use of space, since it allows to lodge several objects.



								Espacio útil Room Espacement					
L	A	H	E	I	a	h	L1	H1	Kg	Barcode	€		
	1.000	550	850	200	340	340	200		500	810-890	15,0	054230	601,00
	1.200	600	890	200	500	400	250		600	810-890	20,0	054214	619,00
	1.200	700	890	200	400	500	250		600	810-890	24,0	054218	692,00
	1.000	550	850	200	340	340	200		500	810-890	15,0	054232	601,00
	1.200	600	890	200	500	400	250		600	810-890	20,0	054216	619,00
	1.200	700	890	200	400	500	250		600	810-890	24,0	054220	692,00
	1.400	550	850	200	400	400	250		500	810-890	22,0	054234	869,00
	1.600	600	890	200	400	400	250		600	810-890	34,0	054222	930,00
	1.600	700	890	200	400	500	250		600	810-890	36,0	054226	960,00
	1.400	550	850	200	400	400	250		500	810-890	22,0	054236	869,00
	1.600	600	890	200	400	400	250		600	810-890	34,0	054224	930,00
	1.600	700	890	200	400	500	250		600	810-890	36,0	054228	960,00

Fregaderos con soporte

Floor-mounted sink units
Éviers avec support



						Sin entrepaño Without shelf Sans étagère			Con entrepaño With shelf Avec étagère			
L	A	H	l	a	h	Kg	Barcode	€	Kg	Barcode	€	
	450	450	850	370	340	170	10,1	050602	356,00	11,2	050802	435,00
	450	500	850	370	340	170	10,5	050604	356,00	11,7	050804	435,00
	600	500	850	500	400	150	12,1	050606	398,00	13,5	050806	488,00
	600	600	850	500	500	300	17,3	054800	537,00	18,9	055000	665,00
	700	600	850	500	400	250	18,5	054802	562,00	20,3	055002	745,00
	700	700	850	500	500	300	18,6	056002	647,00	20,7	056202	835,00
	800	600	850	500	400	250	19,7	054804	672,00	21,7	055004	848,00
	800	700	850	600	500	300	21,2	056004	658,00	28,4	056204	849,00
	1.000	600	850	860	420	350	22,0	054828	919,00	28,0	055028	1.065,00
	1.000	700	850	860	495	375	24,0	056028	991,00	30,0	056228	1.158,00
	1.200	600	850	1.060	420	350	26,0	054830	1.043,00	34,0	055030	1.189,00
	1.200	700	850	1.060	500	375	28,0	056030	1.011,00	46,0	056230	1.188,00
	1.500	600	850	1.160	420	600	31	053812	1.199,00			
	1.500	700	850	1.160	490	600	34	053824	1.261,00			
	1.300	700	850	800	495	370	28,2	053602	1.131,00			
	1.600	700	850	960	500	375	36,7	053606	1.029,00			
	1.300	700	850	800	495	370	28,2	053604	1.131,00			
	1.600	700	850	960	500	375	36,7	053608	1.029,00			
	800	500	850	370	340	120	13,2	050616	402,00	15,0	050816	529,00
	1.000	500	850	420	350	150	14,9	050628	413,00	17,1	050828	549,00
	1.000	550	850	340	340	200	17,5	051802	576,00	23,0	052002	682,00
	1.000	600	850	500	400	250	20,8	054806	648,00	23,2	055006	793,00
	1.000	700	850	500	500	300	22,4	056006	707,00	25,0	056206	868,00
	1.200	600	850	500	400	250	24,5	054810	621,00	27,3	055010	777,00
	1.200	700	850	400	500	250	26,2	056010	715,00	29,3	056210	936,00
	1.300	600	850	500	500	300	26,0	054814	737,00	29,0	055014	904,00
	1.300	700	850	500	500	300	26,7	056014	751,00	29,9	056214	924,00
	1.400	600	850	500	400	250	26,9	054818	721,00	30,1	055018	902,00
	1.400	700	850	600	500	300	28,7	056018	813,00	32,2	056218	999,00
	800	500	850	370	340	120	13,2	050618	402,00	15,0	050818	529,00
	1.000	500	850	420	350	150	14,9	050630	413,00	17,1	050830	549,00
	1.000	550	850	340	340	200	17,5	051804	576,00	23,0	052004	682,00
	1.000	600	850	500	400	250	20,8	054808	648,00	23,2	055008	793,00
	1.000	700	850	500	500	300	22,4	056008	707,00	25,0	056208	868,00
	1.200	600	850	500	400	250	24,5	054812	621,00	27,3	055012	777,00
	1.200	700	850	400	500	250	26,2	056012	677,00	29,3	056212	897,00
	1.300	600	850	500	500	300	26,0	054816	737,00	29,0	055016	904,00
	1.300	700	850	500	500	300	26,7	056016	791,00	29,9	056216	965,00
	1.400	600	850	500	400	250	26,9	054820	721,00	30,1	055020	902,00
	1.400	700	850	600	500	300	28,7	056020	813,00	32,2	056220	999,00

Fregaderos con soporte
Floor-mounted sink units
Éviers avec support

Válido para lavavasos.
Valid for glass washers.
Valide pour machines à laver
verres.



Válido para lavaplatos.
Valid for dish washers.
Valide pour machines à laver
assiettes.

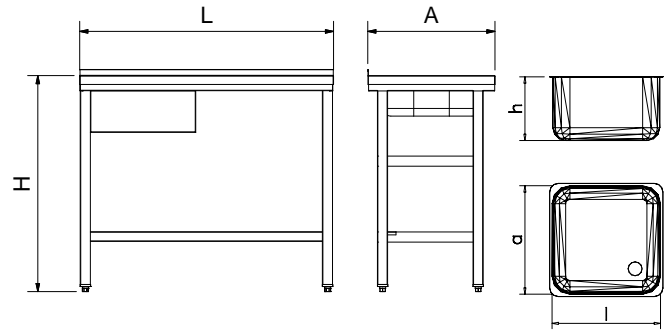

						Sin entrepaño Without shelf Sans étagère							Con entrepaño With shelf Avec étagère	
L	A	H	I	a	h	Kg	Barcode	€	Kg	Barcode	€			
800	500	850	340	370	150	13,9	050610	485,00	15,7	050810	611,00			
1.000	600	850	400	400	250	24,8	054822	866,00	27,2	055022	1.014,00			
1.000	700	850	400	500	250	26,4	056022	954,00	29,0	056222	1.104,00			
1.200	600	850	500	400	250	26,8	054824	946,00	29,6	055024	1.105,00			
1.200	700	850	500	500	300	28,6	056024	973,00	31,6	056224	1.142,00			
1.400	600	850	500	400	250	31,9	054826	919,00	35,1	055026	1.098,00			
1.400	700	850	600	500	300	33,7	056026	1.011,00	37,2	056226	1.201,00			
2.000	600	850	800	420	600	42	054018	1.853,00						
2.000	700	850	800	495	600	48	054036	1.961,00						
1.200	500	850	340	370	150	17,0	050636	540,00	19,5	050836	648,00			
1.400	550	850	400	400	250	21,0	051806	757,00	25,0	052006	850,00			
1.400	600	850	400	400	250	29,4	054832	1.030,00	32,6	055032	1.206,00			
1.400	700	850	400	500	250	31,2	056032	855,00	34,7	056232	1.041,00			
1.600	600	850	400	400	250	33,4	054846	1.114,00	40,5	055046	1.213,00			
1.600	700	850	400	500	250	35,2	056046	1.115,00	42,5	056246	1.227,00			
2.000	600	850	500	400	250	39,7	054840	1.159,00	44,6	055040	1.328,00			
2.000	700	850	600	500	300	41,8	056040	1.309,00	46,5	056240	1.526,00			
1.200	500	850	340	370	150	17,0	050638	540,00	19,5	050838	648,00			
1.400	550	850	400	400	250	21,0	051808	757,00	25,0	052008	850,00			
1.400	600	850	400	400	250	29,4	054834	1.030,00	32,6	055034	1.206,00			
1.400	700	850	400	500	250	31,2	056034	855,00	34,7	056234	1.041,00			
1.600	600	850	400	400	250	33,4	054848	1.114,00	40,5	055048	1.213,00			
1.600	700	850	400	500	250	35,2	056048	1.115,00	42,5	056248	1.227,00			
2.000	600	850	500	400	250	39,7	054842	1.159,00	44,6	055042	1.328,00			
2.000	700	850	600	500	300	41,8	056042	1.309,00	46,5	056242	1.526,00			
2.000	600	850	400	400	250	39,7	054844	998,00	44,0	055044	1.210,00			
2.000	700	850	400	500	250	41,8	056044	1.113,00	46,5	056244	1.333,00			
1.800	600	850	500	400	250	45,0	054850	1.468,00						
1.800	700	850	400	500	300	50,0	056050	1.437,00						



Fregaderos colgantes con cartelas

Wall mounted sinks with brackets

Plonges inox suspendues avec équerres

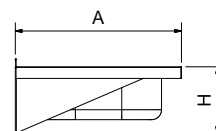
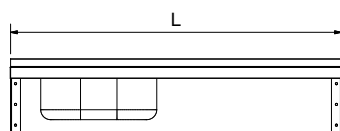
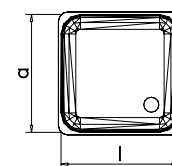
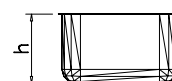

L	A	H	I	a	h	Kg	Barcode	€
450	450	205	370	340	170	4,0	057402	142,00
450	500	205	370	340	170	3,8	057404	165,00
600	500	205	500	400	150	4,8	057406	157,00
600	600	205	500	500	300	9,5	057600	279,00
700	600	205	500	400	250	10,3	057602	340,00
800	600	205	500	400	250	11,0	057604	365,00
1.000	600	205	860	420	350	16,5	057628	573,00
1.200	600	205	1.060	420	350	18,5	057630	685,00
800	500	205	370	340	120	5,1	057416	183,00
1.000	500	205	420	350	150	5,8	057428	200,00
1.000	550	205	340	340	200	10,5	057802	367,00
1.000	600	205	500	400	250	11,0	057606	455,00
1.200	600	205	500	400	250	13,6	057610	374,00
1.300	600	205	500	500	300	14,6	057614	442,00
1.400	600	205	500	400	250	15,0	057618	413,00
800	500	205	370	340	120	5,1	057418	183,00
1.000	500	205	420	350	150	5,8	057430	200,00
1.000	550	205	340	340	200	10,5	057804	367,00
1.000	600	205	500	400	250	11,0	057608	455,00
1.200	600	205	500	400	250	13,6	057612	374,00
1.300	600	205	500	500	300	14,6	057616	442,00
1.400	600	205	500	400	250	15,0	057620	413,00

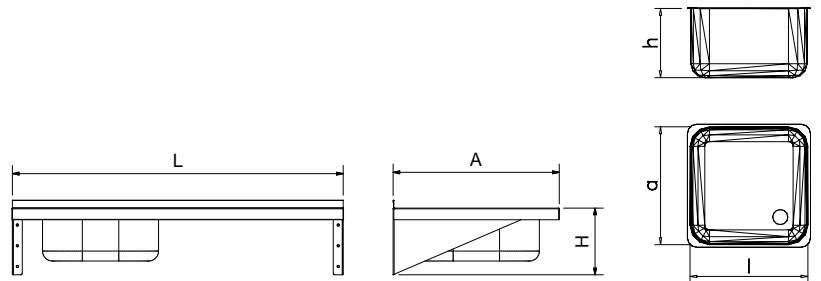

L	A	H	I	a	h	Kg	Barcode	€
800	500	205	340	370	150	5,8	057410	237,00
1.000	600	205	400	400	250	15,0	057622	567,00
1.200	600	205	500	400	250	16,0	057624	588,00
1.400	600	205	500	400	250	20,0	057626	541,00
1.200	500	205	340	370	150	6,8	057436	276,00
1.400	550	205	400	400	250	16,5	057806	420,00
1.400	600	205	400	400	250	17,5	057632	690,00
1.200	500	205	340	370	150	6,8	057438	276,00
1.400	550	205	400	400	250	16,5	057808	420,00
1.400	600	205	400	400	250	17,5	057634	690,00



Fregaderos colgantes con faldón o palomillas

Wall-mounted sink units with skirt or brackets

Éviers suspendus avec habillage ou barres de fixation



							Con faldón With skirt Avec habillage			Con palomillas With brackets Avec barres de fixation		
L	A	H	H1	l	a	h	Kg	Barcode	€	Kg	Barcode	€
450	450	200	450	370	340	170	4,1	050202	187,00	7,0	050402	384,00
450	500	200	450	370	340	170	5,4	050204	349,00	7,6	050404	384,00
600	500	200	450	500	400	150	6,6	050206	374,00	9,0	050406	414,00
600	600	250	450	500	500	300	13,5	054400	561,00	14,8	054600	637,00
700	600	300	450	500	400	250	14,8	054402	611,00	16,0	054602	686,00
700	700	300	450	500	500	300	15,9	055602	673,00	16,6	055802	823,00
800	600	355	450	500	400	250	16,1	054404	658,00	17,2	054604	736,00
800	700	320	450	600	500	300	17,7	055604	701,00	19,1	055804	789,00
1.000	600	355	450	860	420	350	14,5	054428	1.001,00	25,1	054628	1.121,00
1.000	700	340	450	860	495	375	15,5	055628	1.061,00	27,3	055828	1.189,00
1.200	600	355	450	1.060	420	350	16,5	054430	1.181,00	29,4	054630	1.314,00
1.200	700	340	450	1.060	500	375	17,5	055630	1.149,00	31,8	055830	1.288,00
800	500	200	450	370	340	120	8,0	050216	393,00	9,9	050416	434,00
1.000	500	200	450	420	350	150	9,3	050228	398,00	11,3	050428	440,00
1.000	600	355	450	500	400	250	16,5	054406	776,00	18,0	054606	861,00
1.000	700	300	450	500	500	300	18,2	055606	818,00	20,1	055806	906,00
1.200	600	355	450	500	400	250	19,9	054410	739,00	21,5	054610	826,00
1.200	700	300	450	400	500	250	21,6	055610	823,00	23,8	055810	916,00
1.300	600	300	450	500	500	300	21,2	054414	832,00	23,0	054614	921,00
1.300	700	300	450	500	500	300	21,8	055614	854,00	24,2	055814	1.000,00
1.400	600	320	450	500	400	250	22,3	054418	824,00	23,8	054618	920,00
1.400	700	320	450	600	500	300	24,0	055618	917,00	26,2	055818	1.023,00
800	500	200	450	370	340	120	8,0	050218	393,00	9,9	050418	434,00
1.000	500	200	450	420	350	150	9,3	050230	398,00	11,3	050430	440,00
1.000	600	355	450	500	400	250	16,5	054408	776,00	18,0	054608	861,00
1.000	700	300	450	500	500	300	18,2	055608	818,00	20,1	055808	906,00
1.200	600	355	450	500	400	250	19,9	054412	739,00	21,5	054612	877,00
1.200	700	300	450	400	500	250	21,6	055612	784,00	23,8	055812	878,00
1.300	600	300	450	500	500	300	21,2	054416	832,00	23,0	054616	921,00
1.300	700	300	450	500	500	300	21,8	055616	893,00	24,2	055816	1.000,00
1.400	600	320	450	500	400	250	22,3	054420	824,00	23,8	054620	920,00
1.400	700	320	450	600	500	300	24,0	055620	917,00	26,2	055820	1.023,00

Fregaderos colgantes con faldón o palomilla de doble seno

Wall-mounted double bowl sink with skirt or brackets

Plonges suspendus avec habillage ou équerres avec double cuve

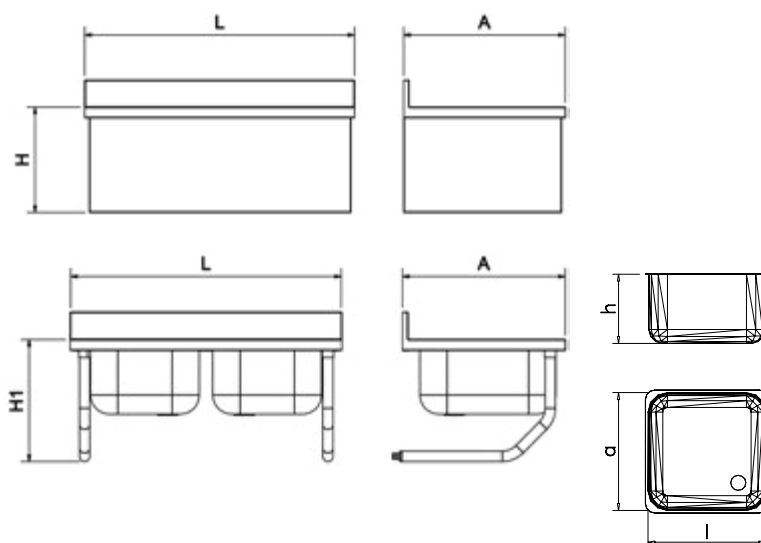

										Con faldón With skirt Avec habillage			Con palomillas With brackets Avec barres de fixation		
L	A	H	H1	l	a	h	Kg	Barcode	€	Kg	Barcode	€			
800	500	200	450	340	370	150	8,7	050210	461,00	10,6	050410	511,00			
1.000	600	355	450	400	400	250	19,8	054422	937,00	21,8	054622	1.046,00			
1.000	700	250	450	400	500	250	21,4	055622	1.031,00	23,9	055822	1.140,00			
1.200	600	355	450	500	400	250	22,2	054424	992,00	23,9	054624	1.105,00			
1.200	700	300	450	500	500	300	23,9	055624	1.027,00	26,1	055824	1.148,00			
1.400	600	320	450	500	400	250	27,3	054426	964,00	28,8	054626	1.084,00			
1.400	700	320	450	600	500	300	29,0	055626	1.063,00	31,2	055826	1.268,00			
1.200	500	200	450	340	370	150	10,9	050236	497,00	13,1	050436	550,00			
1.400	600	250	450	400	400	250	23,6	054432	1.089,00	26,1	054632	1.200,00			
1.400	700	250	450	400	500	250	25,2	055632	1.080,00	28,1	055832	1.195,00			
1.600	600	320	450	400	400	250	29,0	054446	1.175,00	32,0	054646	1.344,00			
1.600	700	320	450	400	500	250	30,0	055646	1.219,00	34,0	055846	1.360,00			
2.000	600	320	450	500	400	250	34,0	054440	1.120,00	36,0	054640	1.270,00			
2.000	700	320	450	600	500	300	35,8	055640	1.415,00	38,8	055840	1.564,00			
1.200	500	200	450	340	370	150	10,9	050238	497,00	13,1	050438	550,00			
1.400	600	250	450	400	400	250	23,6	054434	1.089,00	26,1	054634	1.200,00			
1.400	700	250	450	400	500	250	25,2	055634	936,00	28,1	055834	1.195,00			
1.600	600	320	450	400	400	250	29,0	054448	1.175,00	32,0	054648	1.344,00			
1.600	700	320	450	400	500	250	30,0	055648	1.219,00	34,0	055848	1.360,00			
2.000	600	320	450	500	400	250	34,0	054442	1.120,00	36,0	054642	1.270,00			
2.000	700	320	450	600	500	300	35,8	055642	1.415,00	38,8	055842	1.564,00			
2.000	600	250	450	400	400	250	32,5	054444	1.100,00	35,7	054644	1.249,00			
2.000	700	250	450	400	500	250	34,3	055644	1.380,00	38,6	055844	1.526,00			



Fregaderos con puertas de corredera y abatibles

Sink units with sliding and hinged doors

Éviers à portes coulissantes et à portes à deux battants



Características:

Laterales forrados en acero inoxidable. Entrepaña a 200 mm del suelo. Puertas colgadas, lo que evita depósitos de suciedad en carriles y entrepaño. Escurridor inclinado.

Characteristics:

Sides lined in stainless steel. Hanging doors. They avoid dirtiness deposits in rails and shelves. Undershelf at 200 mm. from the floor.

Caractéristiques:

Latérales recouvertes en acier inoxydable. Portes sont suspendues pour éviter des dépôts de saleté dans les rails et dans les tablettes-rayons. Tablette à 200 mm. du sol.



						Puertas correderas Sliding doors Portes coulissantes			Puertas abatibles Hinged doors Portes battantes		
L	A	H	l	a	h	Kg	Barcode	€	Kg	Barcode	€
600	500	850	500	400	150				21,5	051206	1.085,00
600	600	850	500	500	300				27,6	055400	1.139,00
700	600	850	500	400	250						
800	600	850	500	400	250	28,8	055204	1.252,00	22,6	055404	1.410,00
800	700	850	600	500	300	32,0	056404	1.553,00	35,8	056604	1.750,00
1.000	600	850	860	420	350	36,0	055228	1.449,00	40,0	055428	1.639,00
1.000	700	850	860	495	375	40,0	056428	1.702,00	44,0	056628	1.913,00
1.200	600	850	1.060	420	350	43,0	055230	1.824,00	50,0	055430	2.051,00
1.200	700	850	1.060	500	375	46,0	056430	1.960,00	54,0	056630	2.213,00
800	500	850	370	340	120	21,8	051016	983,00	25,6	051216	1.098,00
1.000	500	850	420	350	150	25,7	051028	1.030,00	29,5	051228	1.148,00
1.000	600	850	500	400	250	32,2	055206	1.318,00	36,0	055406	1.469,00
1.000	700	850	500	500	300	35,8	056406	1.549,00	39,6	056606	1.735,00
1.200	600	850	500	400	250	37,2	055210	1.325,00	41,0	055410	1.490,00
1.200	700	850	400	500	250	41,0	056410	1.543,00	44,8	056610	1.733,00
1.300	600	850	500	500	300	40,8	055214	1.505,00	46,5	055414	1.688,00
1.300	700	850	500	500	300	43,7	056414	1.676,00	49,4	056614	1.886,00
1.400	600	850	500	400	250	42,3	055218	1.562,00	48,0	055418	1.759,00
1.400	700	850	600	500	300	46,5	056418	1.824,00	52,2	056618	2.039,00
800	500	850	370	340	120	21,8	051018	983,00	25,6	051218	1.098,00
1.000	500	850	420	350	150	25,7	051030	1.030,00	29,5	051230	1.148,00
1.000	600	850	500	400	250	32,2	055208	1.318,00	36,0	055408	1.469,00
1.000	700	850	500	500	300	35,8	056408	1.549,00	39,6	056608	1.735,00
1.200	600	850	500	400	250	37,2	055212	1.325,00	41,0	055412	1.490,00
1.200	700	850	400	500	250	41,0	056412	1.504,00	44,8	056612	1.694,00
1.300	600	850	500	500	300	40,8	055216	1.505,00	46,5	055416	1.688,00
1.300	700	850	500	500	300	43,7	056416	1.715,00	49,4	056616	1.924,00
1.400	600	850	500	400	250	42,3	055220	1.562,00	48,0	055420	1.759,00
1.400	700	850	600	500	300	46,5	056420	1.824,00	52,2	056620	2.039,00

Fregaderos con puertas de corredera y abatibles

Sink units with sliding and hinged doors

Éviers à portes coulissantes et à portes à deux battants

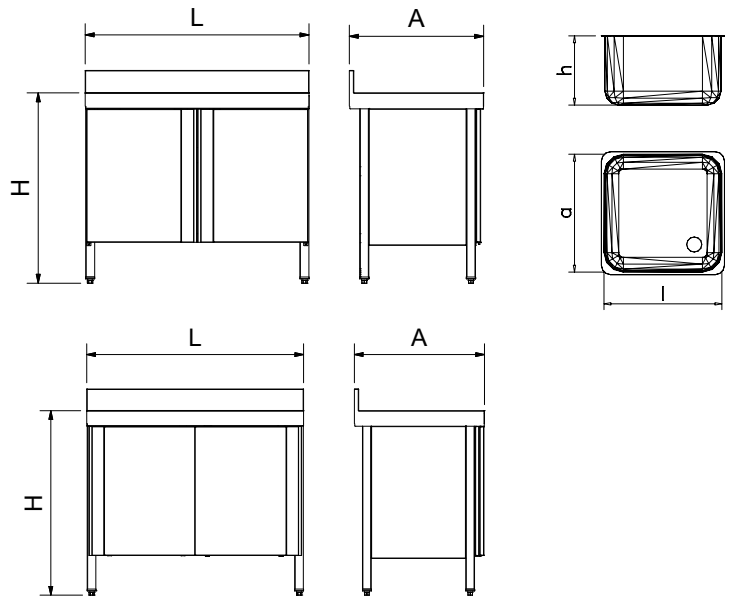

							Puertas correderas Sliding doors Portes coulissantes			Puertas abatibles Hinged doors Portes battantes		
L	A	H	l	a	h	Kg	Barcode	€	Kg	Barcode	€	
800	500	850	340	370	150	25,5	051010	1.022,00	26,3	051210	986,00	
1.000	600	850	400	400	250	36,0	055222	1.433,00	39,8	055422	1.614,00	
1.000	700	850	400	500	250	39,6	056422	1.702,00	43,4	056622	1.902,00	
1.200	600	850	500	400	250	39,4	055224	1.536,00	43,2	055424	1.727,00	
1.200	700	850	500	500	300	43,3	056424	1.707,00	47,1	056624	1.921,00	
1.400	600	850	500	400	250	47,1	055226	1.647,00	52,8	055426	1.862,00	
1.400	700	850	600	500	300	51,2	056426	1.911,00	56,9	056626	2.151,00	
1.200	500	850	340	370	150	22,3	051036	1.130,00	26,1	051236	1.148,00	
1.400	600	850	400	400	250	44,7	055232	1.772,00	50,4	055432	1.974,00	
1.400	700	850	400	500	250	48,9	056432	1.804,00	54,6	056632	2.149,00	
1.600	600	850	400	400	250	52,0	055246	2.086,00	57,0	055446	2.349,00	
1.600	700	850	400	500	250	56,0	056446	2.339,00	61,5	056646	2.631,00	
2.000	600	850	500	400	250	60,7	055240	2.189,00	68,3	055440	2.694,00	
2.000	700	850	600	500	300	65,8	056440	2.664,00	73,4	056640	2.992,00	
1.200	500	850	340	370	150	22,3	051038	1.130,00	26,1	051238	1.148,00	
1.400	600	850	400	400	250	44,7	055234	1.772,00	50,4	055434	1.974,00	
1.400	700	850	400	500	250	48,9	056434	1.804,00	54,6	056634	2.149,00	
1.600	600	850	400	400	250	52,0	055248	2.086,00	57,0	055448	2.349,00	
1.600	700	850	400	500	250	56,0	056448	2.339,00	61,5	056648	2.631,00	
2.000	600	850	500	400	250	60,7	055242	2.189,00	68,3	055442	2.694,00	
2.000	700	850	600	500	300	65,8	056442	2.664,00	73,4	056642	2.992,00	
2.000	600	850	400	400	250	60,7	055244	2.281,00	68,3	055444	2.773,00	
2.000	700	850	400	500	250	65,8	056444	2.554,00	73,4	056644	2.877,00	



Fregaderos portátiles

Mobile sinks
Plonges portables



054210

054240

054244





054212

054242

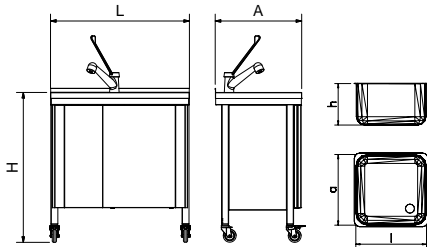
054246



Funcionamiento Operation Opération	Autónomo-Hidráulico Autonomous-Hydraulic Autonome-Hydraulique	*Batería *Battery *Batterie	Conexión a red eléctrica Mains connection Raccordement au réseau
Tipo de accionamiento Operation Accionnement			
Agua fría Cold water Eau froide	<input checked="" type="checkbox"/>	<input checked="" type="checkbox"/>	<input checked="" type="checkbox"/>
Agua caliente Hot water Eau chaude	Opcional Optional Optionnel	Opcional Optional Optionnel	<input checked="" type="checkbox"/>
Potencia Power Puissance	-----	-----	2.000 W
Tensión Voltage Tension	-----	12 V	220-240 V
Frecuencia Frequency Fréquence	-----	-----	50-60 Hz.
L	800 mm	800 mm	800 mm
A	500 mm	500 mm	500 mm
H	850 mm	850 mm	850 mm
Peso / Weight / Poids	25,00 Kg.	26,00 Kg.	31,00 Kg.
Dimensiones cubeta Bowl dimensions Dimensions évier	370x340 mm	370x340 mm	370x340 mm
Profundidad cubeta Bowl depth Profondeur évier	120 mm	120 mm	120 mm
Capacidad agua limpia Clean water tank capacity Capacité eau propre	25 l.	25 l.	25 l.
Capacidad agua sucia Dirty water tank capacity Capacité eau sale	25 l.	25 l.	25 l.
	1.140,00€	1.485,00€	1.525,00€

*Incluye cargador de batería. 220-240 V 50-60 Hz.
*Includes battery charger. 220-240 V 50-60 Hz.
*Chargeur de batterie inclus. 220-240 V 50-60 Hz.

Elevador inox de fondo de fregaderos

Stainless steel bottom lifter for sinks

Élévateur en acier inoxydable pour plonge

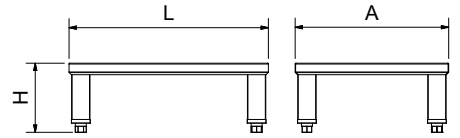

L	A	H	Para cubetas de For sinks of Pour les plonges de	Kg	Barcode	€
435	335	150	500x400	1,5	051620	47,00
435	435	150	500x500	1,8	051622	52,00

Fregadero vertedero

Sink-drain

Eviers-déversoir



Características:

Totamente construido en acero inoxidable.
Bastidor soldado, construido en tubo de 40x40 mm que garantiza una máxima solidez y resistencia al peso de grandes ollas y cubos.
Encimera con reborde salva-aguas.

Tapa soporte para cubos y ollas.
Sheet-support for pots and buckets.
Plaque-support pour pots seaux.

Barcode 054209 € **75,00**

L 620 mm. A 520 mm.

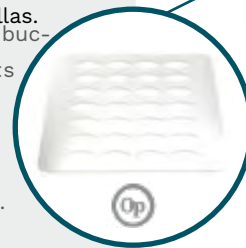

Op Opcional / Optional / Optionnel

Characteristics:

Wholly made of stainless steel.
Welded frame, made in tube 40x40, which guarantees the highest stability and solidity for the weight of big pots and buckets.
Top with water-safe edge.

Caractéristiques:

Totalement en acier inoxydable.
Structure soudée, fabriqué en tube 40x40, lequel garantit la meilleure stabilité et solidité pour le poids des grands pots et seaux.
Partie supérieure avec rebord contre écoulement d'eau.

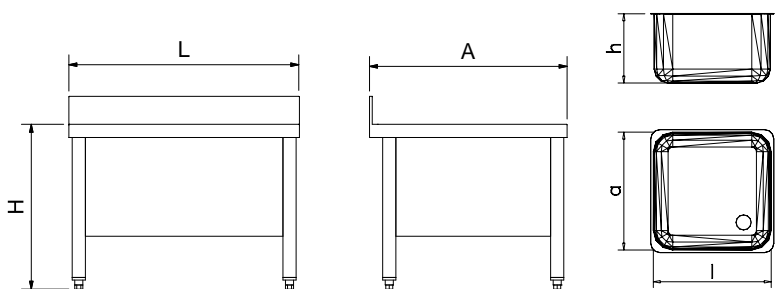

L	A	H	l	a	h	Kg	Barcode	€
700	600	550	500	400	250	16	054208	625,00

Fregadero especial para escayolas

Sink unit with integral sump. Specially for plaster preparation
Evier avec bouche intégré. Spécial pour le préparation des pâtres

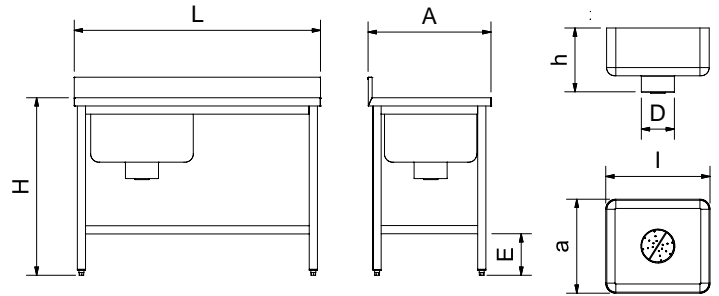
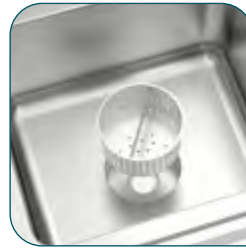

	L	A	H	I	a	D	h	E	Kg	Barcode	€
	1.200	600	850	500	500	160	200	200	24	076202	1.100,00
	1.200	600	850	500	500	160	200	200	24	076204	1.100,00

Fregadero para bicicletas XL

XL bike sink
Plonge à vélo XL

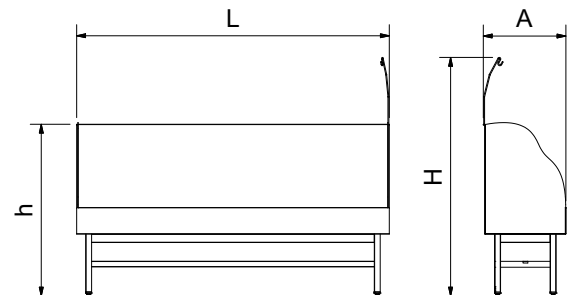

L	A	H	h	Kg	Barcode	€
2.120	560	1.620	1.165	55,0	054252	1.155,00

Novedad
en
frigoríficos

Calentador de agua instantáneo

Instant water heater
Chauffe-eau instantané



Temperatura de salida del agua de 35°C a 50°C
Leaving water temperature 35°C - 50°C
Température de sortie d'eau 35°C - 50°C

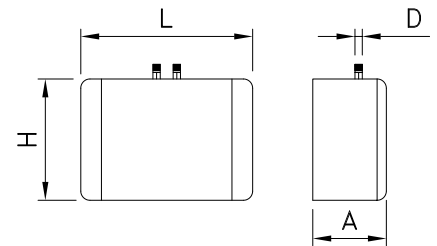

L	A	H	D	°C	l/h	Potencia Power Puissance	Tensión Voltage Tension	Frecuencia Frequency Fréquence	Kg	Barcode	€
165	70	200	3/8"	50°C	2,0	3.500 W	230 V	50 Hz.	1,1	461456	265,00

Enfriador de agua

Water cooler
Refrigeriseur d'eau

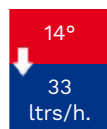

Características:

Ideal para instalar agua fría en fregaderos, lavamanos, fuentes, etc.

Tecnología para mejorar la higiene.

Termostato para regular la temperatura del agua.

Ahorro de energía gracias a su compresor de 1/4 Hp.

CE

Fabricado en la unión Europea.

Envolverte de acero pintado.

Entrada y salida de agua de 1/2"

Caractéristiques:

Ideal pour installer de l'eau froide sur des éviers, lavemains, fontaines, etc.

Technologie pour améliorer l'hygiène.

Thermostat pour régler la température de l'eau.

Economie d'énergie grâce à son compresseur de 1/4 Hp.

CE

Fabriqué en Union Européenne

Entrée et sortie d'eau grâce à une connexion 1/2".

Acier peint.

Characteristics:

Ideal for incorporating cool water in sink units, hand washbasins, drinking fountains, etc.

Technology for a better hygiene

Temperature adjustment by thermostat

Energy saving through compressor - 1/4 Hp

CE

Made in UE

Inlet and outlet connectors 1/2".

Painted steel.

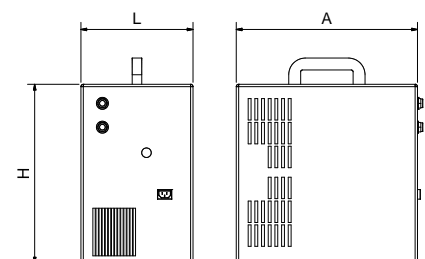

L	A	H	Potencia Power Puissance	Tensión Voltage Tension	Frecuencia Frequency Fréquence	Kg	Barcode	€
300	400	470	230 W	220-240 V	50 Hz.	18,0	461460	810,00

Enjuagador de vasos y jarras a presión para fregadero

Pressure sink washer for glasses and jugs
Nettoyeur haute pression pour verres et pichets pour évier



Novedad
ew
nouveauté

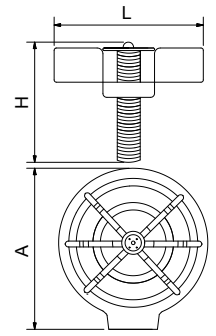

L	A	H	Gr	Barcode	€
150	130	173	200	454280	25,00

Cepillo lavavasos

Glass washer brush
Brosse pour lave-verres

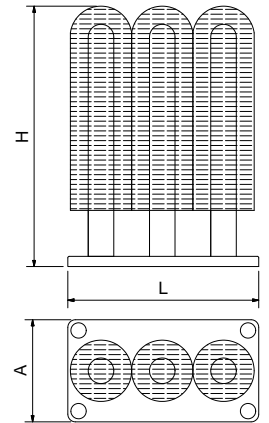

L	A	H	Gr	Barcode	€
190	100	190	390	483062	24,00

Rollo de 3m de bayeta posavasos antideslizante multiusos

Multipurpose non-slip coaster cloth, 3m roll
Rouleau de 3 m de tissu anti-dérapant multi-usages



Novedad
ew
nouveauté

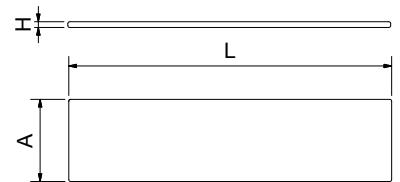

L	A	H	Kg	Barcode	€
3.000	650	1,00	1,00	482050	27,00

Repuestos fregaderos

Spare parts for sink units
Pièces de rechange pour éviers



Rebosadero (fregaderos serie 600 y 700 mm)
Overflow (sink units models 600 & 700 mm width)
Déversoir (éviers 600 et 700 mm de profondeur)

Descripción
Description
Description

Modelo
Model
Model

Gr

















€

250 mm	420	454220	55,00
290 mm	450	454222	57,50
340 mm	525	454224	52,00
490 mm	600	454225	61,00

Repuestos fregaderos

Spare parts for sink units

Pièces de rechange pour éviers

	Descripción Description Description	Modelo Model Model	Gr		€
	Válvula sin rebosadero Ø 49 mm (fregaderos serie 500, 600 y 700 mm) Drain valve without overflow Ø 49 mm (sink units models 500, 600 & 700 mm) Valvule de drainage sans déversoir Ø 49 mm (éviers model 500, 600 et 700 mm)	1 1/2"	88	454226	10,00
	Valvula desagüe con cestillo  Drain valve with basket for waste Vanne de vidange avec panier		50	454212	6,50
	Reductor desagüe de 2" a 1 1/2" Drain reducer from 2" to 1 1/2" Réducteur pour drainage de 2" à 1 1/2"		150	454218	18,90
	Tapón fregaderos, para válvulas de Ø 49 mm serie 600 y 700 Sink unit plug for valve Ø 49 mm series 600 & 700 Bonde pour valvule Ø 49 mm évier série 600 et 700		20	454604	3,15
	Válvula con rebosadero (fregaderos serie 500 mm, lavamanos, cubetas semiesféricas y fregaderos de gran capacidad) Drain valve with overflow (sink units model 500 mm, washbasins, semispheric bowls, and large capacity single sink units) Valvule de drainage avec déversoir (éviers model 500 mm, lave-mains, semisphériques cuveaux et éviers a grande capacité)	1 1/2"	145	454202	6,00
	Válvula de PVC con rebosadero, acabado cromado Drain valve in PVC with overflow, chrome finished Valvule de drainage avec déversoir en PVC, finition chromé	1 1/2"	150	454205	43,00
	Válvula sin rebosadero (fregaderos serie 500 mm) Drain valve without overflow (sink units model 500 mm) Valvule de drainage sans déversoir (éviers model 500 mm)	1 1/2"	88	454208	10,50
	Válvula de descarga rápida Quick drain valve Valvule pour rapide drainage	2"	3.600	454204	115,00
	Tapón inox cubre-agujeros (diámetro 42 mm) Hole-cover plug in stainless steel (diameter 42 mm) Bonde couvre-trou en acier inox (diamètre 42 mm)		16	454602	3,00
	Sifón de desagüe (fregaderos ancho 500 mm, lavamanos, gran capacidad) U-bended drainpipe (sink units 500 mm depth, washbasins, high capacity) Siphon de drainage (éviers profondeur 500 mm, lave-mains, grand capacité)	1 1/2"	169	454402	6,00
	Sifón de PVC acabado cromado U-bended drainpipe in PVC, chrome finish Siphon en PVC, finition chromé	1 1/2"	170	454408	36,00
	Sifón de latón cromado U-bended drainpipe in chrome brass Siphon en laiton chromé	1 1/2"	1.400	454404	80,00
	Hacer agujero en fregadero o lavamanos Drill hole to sink Faire trou à plonge	2"	2.000	454406	122,00
				056802	33,00

Válvula de desagüe Splus modelo simple

Sink drain - Splus individual model
Bonde Splus modèle simple



An effective system for optimizing the space!!!

Characteristics:

A system specially designed for better use of space under sinks, since it allows moving the drain towards the wall.

Un véritable système d'utilisation optimale de l'espace!

Caractéristiques:

Système conçu pour utiliser au mieux l'espace sous l'évier car on peut déplacer la bonde vers le mur.

Un verdadero sistema de optimización del espacio!!!

Características:

Sistema diseñado para aprovechar mejor el espacio bajo los fregaderos ya que permite desplazar el desagüe hacia la pared.



Modelo Model Model	Gr	454209	€
1 1/2	48	454209	18,90

Válvula de desagüe Splus modelo doble

Sink drain - Splus double model
Bonde Splus modèle double

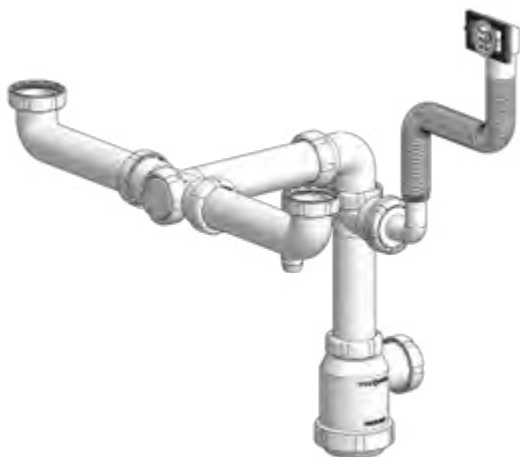

An effective system for optimizing the space!!!

Characteristics:

A system specially designed for better use of space under sinks, since it allows moving the drain towards the wall.

Un véritable système d'utilisation optimale de l'espace!

Caractéristiques:

Système conçu pour utiliser au mieux l'espace sous l'évier car on peut déplacer la bonde vers le mur.

Un verdadero sistema de optimización del espacio!!!

Características:

Sistema diseñado para aprovechar mejor el espacio bajo los fregaderos ya que permite desplazar el desagüe hacia la pared.



Modelo Model Model	Gr	454210	€
1 1/2	64	454210	26,00

Trampa inox para grasas de 20 lts.
 Stainless steel grease trap 20 lts.
 Piège de graisse acier inoxydable 20 lts.



Características:

Diseñado para restaurantes, hoteles, fastfood, etc..
 Fácil instalación y mantenimiento.
 Rendimiento de 0 a 50 comidas.
 Incluye:
 Latiguillo flexible de evacuación.
 Cestillo.
 Desagües flexibles para la entrada y salida de agua.



Characteristics:

Applicable for restaurant, hotels, fast food, etc.
 Easy installation and maintenance.
 Capacity from 0 to 50 meals.
 Includes:
 Evacuation flexible hose.
 Basket.
 Flexible drains for water inlet and outlet.

Caractéristiques:

Approprié aux restaurants, hôtels, fast-food, etc.
 Installation et entretien faciles.
 Capacité de 0 à 50 repas.
 Comprend:
 Evacuation flexible.
 Réservoir.
 Flexible drains pour entrée et sortie d'eau.

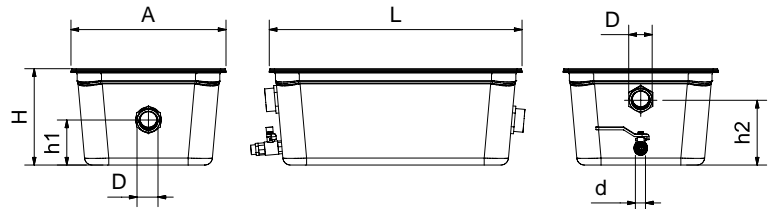

L	A	H	D	d	h1	h2	lit	Kg	Barcode	€
530	325	200	1" 1/2	1/2"	97	136	20	4,80	057202	274,00

Trampa inox para grasas de 35 lts.
 Stainless steel grease trap 35 lts.
 Piège de graisse acier inoxydable 35 lts.



Características:

Fabricado totalmente en acero inoxidable.
 Rendimiento de 0 a 65 comidas.
 Caudal: 1l/sg.
 Incluye: Tapa estanca de acero inoxidable y cestillo registrable.
 Capacidad: 35 litros.

Characteristics:

Wholly made of stainless steel.
 Capacity from 0 to 65 meals.
 Volume: 1l/sc.
 Included: Stainless steel airtight lid and basket.
 Capacity: 35 liters.

Caractéristiques:

Fabriqué entièrement en acier inoxydable.
 Capacité de 0 à 65 repas.
 Débit : 1l/sc.
 Inclus : Couvercle étanche and panier.
 Capacité: 35 litres.

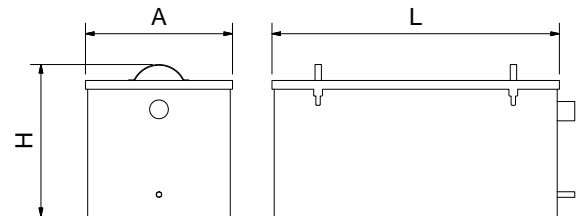

L	A	H	lit	lit	Kg	Barcode	€
560	320	300	60	35	9,50	455004	299,00

Sumidero sifónico con cestillo salida vertical en acero inoxidable
 Stainless steel floor drain with siphon trap and vertical outlet
 Bouche dégout siphonique sortie verticale en acier inoxydable

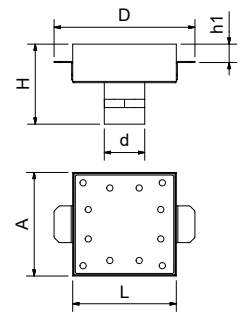

Novedad
 ew
 nuevo



L	A	H	h1	D	d	Kg	Barcode	€
---	---	---	----	---	---	----	---------	---

100	100	112	-	100	48	1,20	054274	129,00
-----	-----	-----	---	-----	----	------	--------	---------------



150	150	155	40	222	75	2,96	054270	129,00
-----	-----	-----	----	-----	----	------	--------	---------------

Novedad
 ew
 nuevo



200	200	155	36	272	78	3,00	054276	150,00
-----	-----	-----	----	-----	----	------	--------	---------------

Novedad
 ew
 nuevo



250	250	155	36	322	78	4,00	054278	189,00
-----	-----	-----	----	-----	----	------	--------	---------------

Novedad
 ew
 nuevo



300	300	155	36	340	78	5,40	054280	243,00
-----	-----	-----	----	-----	----	------	--------	---------------

Sumidero sifónico con cestillo salida horizontal en acero inoxidable

Stainless steel floor drain with siphon trap and horizontal outlet
Bouche dégout siphonique sortie horizontale en acier inoxydable

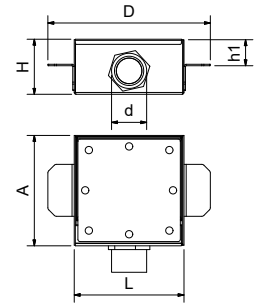

Novedad en BusVest



L	A	H	h1	D	d	Kg	Barcode	€
100	100	75	-	100	48	1,10	054282	85,00

Novedad en BusVest



150	150	75	36	222	48	2,00	054284	145,00
-----	-----	----	----	-----	----	------	--------	---------------

Novedad en BusVest



200	200	75	40	272	48	2,28	054272	145,00
-----	-----	----	----	-----	----	------	--------	---------------

Novedad en BusVest



250	250	75	36	322	48	3,70	054286	178,00
-----	-----	----	----	-----	----	------	--------	---------------

Novedad en BusVest



300	300	75	36	340	48	5,00	054288	238,00
-----	-----	----	----	-----	----	------	--------	---------------

Canal colector industrial para interiores en acero inoxidable

Indoor industrial channel drain in stainless steel
Caniveau collecteur industriel pour intérieurs en acier inoxydable



Novedad en BusVest

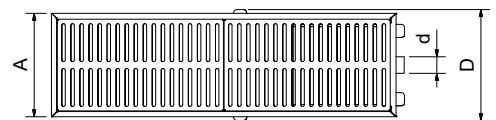
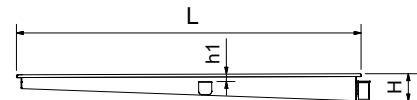

L	A	H	h1	D	d	Kg	Barcode	€
1.000	300	75	22	322	48	10,00	054290	465,00

1.484	300	75	22	322	48	15,00	054292	582,00
-------	-----	----	----	-----	----	-------	--------	---------------

2.448	300	75	22	322	48	24,00	054296	838,00
-------	-----	----	----	-----	----	-------	--------	---------------

Sistema modular de canal ranurado

Slot channel, modular concept
Système modulaire de canal avec rainures



Sumidero para canal modular ranurado de salida vertical convertible a horizontal 200x200 mm.

Floor drain for slot channel with vertical outlet convertible to horizontal, 200x200 mm.

Siphon pour caniveau modulaire à fentes avec sortie verticale transformable en horizontale 200x200 mm.



Novedad
NEW
DESIGN

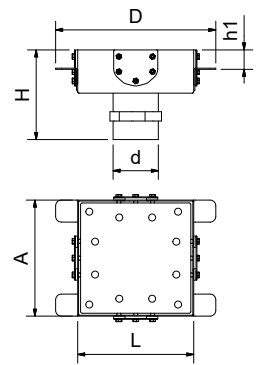

L	A	H	h1	D	d	Kg	Barcode	€
200	200	155	34	275	78	3,00	054260	160,00

Tramo para canal modular o canalina

Section of 850 mm. for modular channel

Section pour caniveau modulaire ou caniveau 850 mm.



Novedad
NEW
DESIGN

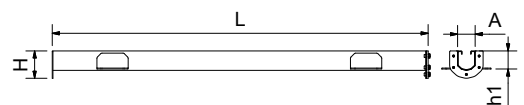

L	A	H	h1	Kg	Barcode	€
850				1,60	054264	47,00
1.700	40	62	41	3,00	054266	67,00



GRIFERIA

TAPS AND FITTINGS
ROBINETTERIE

NOVEDADES

NEWS
NOUVEAUTÉS



250



250



250



258



259



260



260



262



263



265



265



272



273



Grifos ducha de sobremesa

Deck mounted pre-rinse units
Robinets douchettes sur table



	463068	463054	463056	463046	463090	463076
Serie	Basic	RD	RD	LV	LV	EXT
L	450	450	450	450	450	450
H	1.200	1.300	1.300	1.300	1.300	1.050
D	1/2"	1/2"	1/2"	1/2"	1/2"	1/2"
	17	17	17	17	17	17
	80°C	80°C	80°C	80°C	80°C	80°C
	4,15	4,40	4,42	4,50	5,70	4,00
	167€	201€	207€	225€	308€	475€



	463070	463058	463060	463048	463092	463078
Serie	Basic	RD	RD	LV	LV	EXT
L	450	450	450	450	450	250
H	1.200	1.300	1.300	1.300	1.300	1.050
D	1/2"	1/2"	1/2"	1/2"	1/2"	1/2"
	17	17	17	17	17	17
	80°C	80°C	80°C	80°C	80°C	80°C
	4,95	5,20	5,26	5,60	6,80	5,00
	232€	273€	269€	290€	370€	535€

Grifos ducha de sobremesa monomando

Deck mounted single lever pre-rinse units

Robinets douchettes sur table mitigeur



	463086	463074	463072
Serie	MNE	MN	MN
L	450	450	450
H	1.300	1.300	1.300
D	1/2"	3/8"	1/2"
	17	17	17
	80°C	80°C	80°C
	5,11	4,80	5,00
	266€	275€	825€





	463088	463062	463052	463094
Serie	MNE	Monoblock	MNX	Monoblock
L	450	450	230	450
H	1.300	1.300	900	1.300
D	1/2"	1/2"	3/8"	1/2"
	17	17	18	17
	80°C	80°C	80°C	80°C
	5,91	5,90	5,80	5,90
	335€	339€	409€	495€

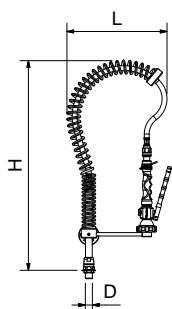

Grifos ducha de sobremesa extra bajos

Short deck mounted pre-rinse units
Robinets douchettes sur table extra bas

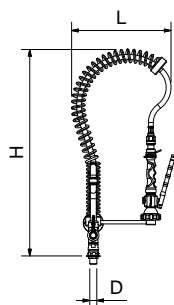

	463034	463080	463038
Serie	Basic	RD	MN
L	450	450	450
H	600	600	600
D	1/2"	1/2"	1/2"
 1/4"	17	17	17
 80°C	80°C	80°C	80°C
 Kg	3,60	3,50	3,70
	208€	245€	319€





	463036	463081	463040	463032
Serie	Basic	RD	MN	Monoblock
L	450	450	450	450
H	600	600	600	600
D	1/2"	1/2"	1/2"	1/2"
 1/4"	17	17	17	17
 80°C	80°C	80°C	80°C	80°C
 Kg	4,90	4,00	4,20	5,60
	266€	297€	371€	369€



Grifos ducha murales

Wall-mounted pre-rinse units
Robinets douchettes muraux

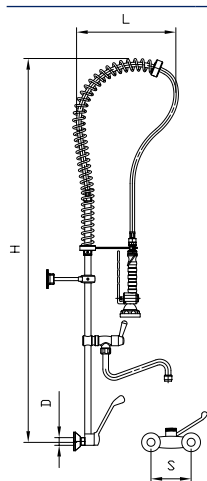

	463064	463042
Serie	MN	LV
L	450	450
H	1.250	1.250
D	1/2"	1/2"
S	150	150
	17	17
	4,60	5,70
	295€	229€



	463066	463044	463096	463098
Serie	MN	LV	Monoblock	Monoblock
L	450	450	450	450
H	1.250	1.250	1.250	600
D	1/2"	1/2"	1/2"	1/2"
S	150	150	150	150
	17	17	20	20
	5,40	6,80	4,70	4,70
	360€	285€	505€	577€

Expositor central de grifería
Centre taps and shower display
Exposant de robinetterie centrales



Se pueden exponer 8 grifos por nivel.
8 taps on each level.
8 robinets par niveau.



El precio no incluye la grifería.
Taps not included in the price.
Le prix n'inclut pas la robinetterie.

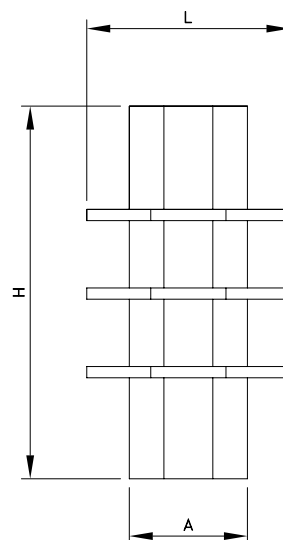

L	A	H	Kg	Barcode	€
1.690	530	2.300	44,00	064402	915,00

Expositor mural de grifería
Wall mounted taps and shower display
Exposant de robinetterie mural

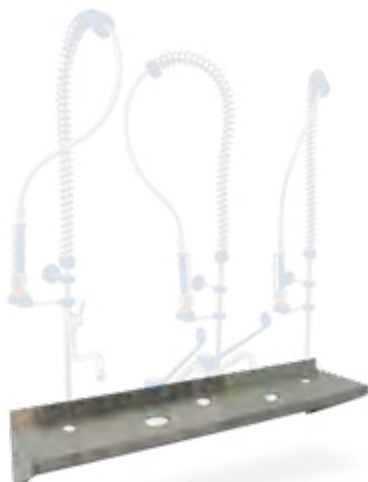

Se pueden exponer 5 grifos por nivel.
5 taps on each level.
5 robinets par niveau.



El precio no incluye la grifería.
Taps not included in the price.
Le prix n'inclut pas la robinetterie.

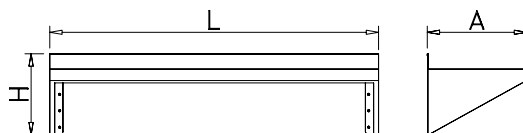

L	A	H	Kg	Barcode	€
1.250	300	245	4,00	064404	175,00

Expositor mural de grifería con grifos
Wall-mounted display with pre-rinse units and taps
Exposant de robinetterie mural avec robinet



463056
463060
463062
463214
463602

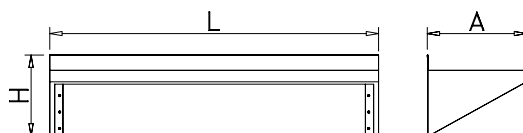

L	A	H	Kg	Barcode	€
1.250	300	245	23,00	970980101	1.177,00

Grifo ducha sobremesa serie doméstico con piña

Domestic shower fitting with head
Robinet douche modèle domestique avec pomme de douche

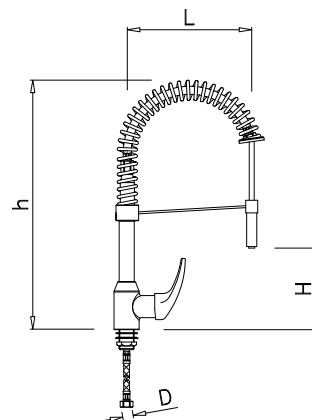

L	H	h	D	Water saving	Temp. °C	Kg	Barcode	€
230	150	500	1/2"	17	80°C	3,50	463051	290,00

Grifo sobremesa de un agua serie 1/4 de vuelta

Single inlet 1/4 turn model table tap
Robinet à une eau sur table modèle 1/4 de tour

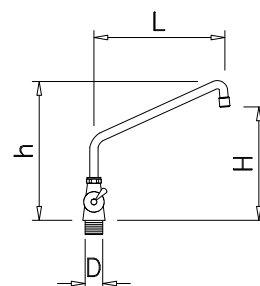

L	H	h	D	Water saving	Kg	Barcode	€
250	230	290	1/2"	16	1,00	463426	90,00

Grifo cocina monomando sobremesa de acero inoxidable

Stainless steel single lever kitchen tap
Robinet de cuisine

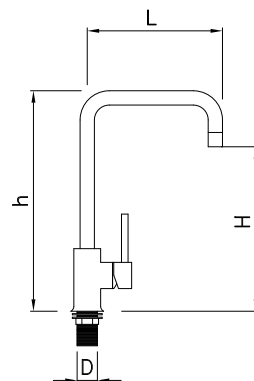

L	H	h	D	Water saving	Kg	Barcode	€
180	290	355	1/2"	9,5	2,00	465206	77,00

Grifo cocina monomando sobremesa cuello de cisne de acero inoxidable

Stainless steel single lever gooseneck tap
Robinet mélangeur sur table avec col de cygne en acier inoxydable

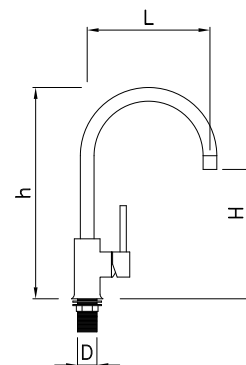

L	H	h	D	Water saving	Kg	Barcode	€
180	230	320	3/8" - 1/2"	9,5	3,00	465210	90,00

Grifo monomando sobremesa caño alto para fregadero

Single lever sink tap, high spout
Mélangeur évier col de cygne haut

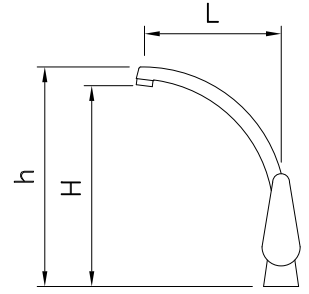

L	H	h	D					€
190	260	290	3/8"	16	0,89	464624		69,00

Grifo ducha monomando sobremesa dos aguas serie doméstico

Double inlet single lever shower fitting, domestic series
Robinet douche sur table à deux eaux modèle domestic

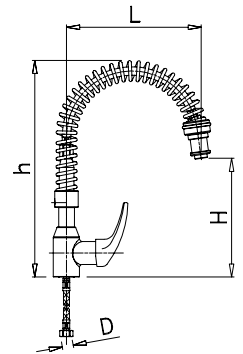

L	H	h	D					€
230	235	415	1/2"	18	80°C	4,00	463050	210,00

Grifo monomando sobremesa extensible de codo

Double inlet single lever pull out tap, elbow functioning
Robinet monocommande à coude, douche extensible



Longitud de manguera: 1,5 mts.
Hose length: 1,5 mts.
Longueur du tuyau: 1,5 mts.

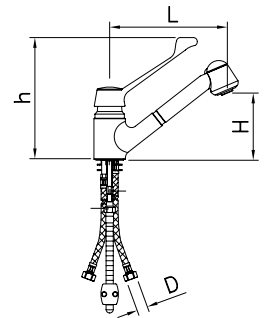

L	H	h	D				€
200	105	250	1/2"	18	3,00	463206	155,00

Grifo monomando sobremesa extensible de codo leva larga

Double inlet single lever pull out tap, elbow functioning with long handle
Robinet mitigeur douchette extractible pomme longue



Longitud de manguera: 1,5 mts.
Hose length: 1,5 mts.
Longueur du tuyau: 1,5 mts.

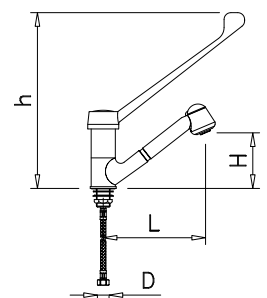

L	H	h	D				€
200	110	290	1/2"	13	1,40	463236	108,00

Grifo monomando sobremesa de codo dos aguas

Double inlet single lever tap, elbow functioning
Robinet monocommande à coude pour deux eaux

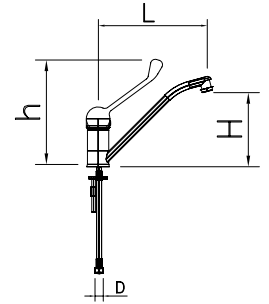

L	H	h	D	WATER	Kg	Barcode	€
200	110	170	3/8"	17	1,16	463204	49,00

Grifo monomando sobremesa de codo dos aguas serie monoblock

Double inlet single lever elbow functioning tap, monoblock series
Robinet monocommande à coude pour deux eaux modèle monoblock

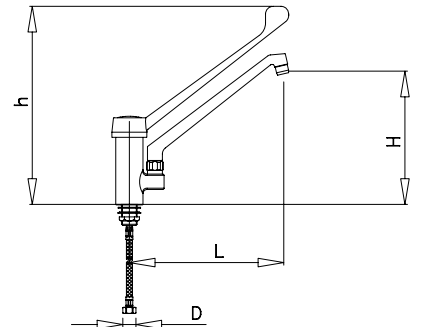

L	H	h	D	WATER	Kg	Barcode	€
250	160	380	1/2"	22	2,46	463214	149,00

Grifo monomando sobremesa giratorio dos aguas

Double inlet rotating mixer tap
Robinet monocommande giratoire deux eaux

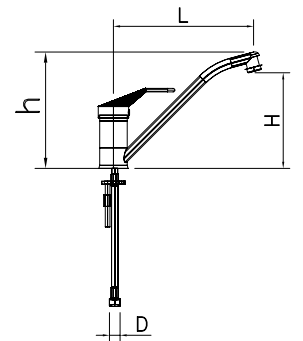

L	H	h	D	WATER	Kg	Barcode	€
200	110	130	3/8"	17	1,19	463602	38,00

Grifo monomando sobremesa caño giratorio elevado

Single lever tap with high rotating spout
Robinet monocommande sur table avec jet giratoire élevé

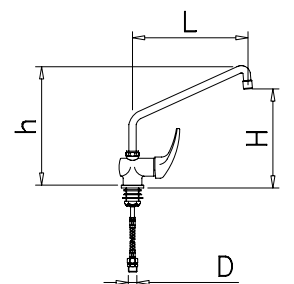

L	H	h	D	WATER	Kg	Barcode	€
300	280	350	3/8"	17	2,06	463226	137,00

Grifo de cocina efecto granito

Granite effect kitchen tap
Robinet de cuisine effet granit

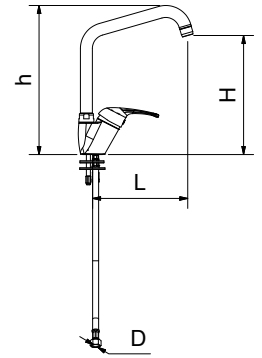

L	H	h	D	litros/min	°C	Kg	Barcode	€
300	265	325	3/8"	17	80°C	1,70	464632	253,00
							464633	

Grifo monomando sobremesa de codo dos aguas serie monoblock-elevado

Double inlet single lever elbow functioning tap, high monobloc series
Robinet monocommande à coude pour deux eaux modèle monoblock-haut

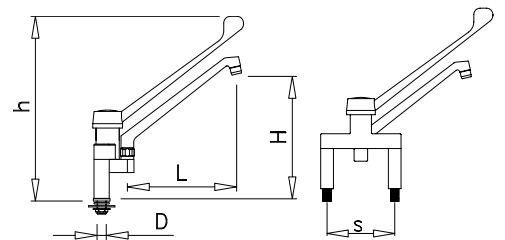

L	H	h	D	S	litros/min	Kg	Barcode	€
200	210	520	1/2"	155	22	3,83	463216	215,00

Grifo monomando sobremesa para fregadero serie Ecológica

Single lever sink tap, Eco series
Mélangeur de table série écologique pour évier

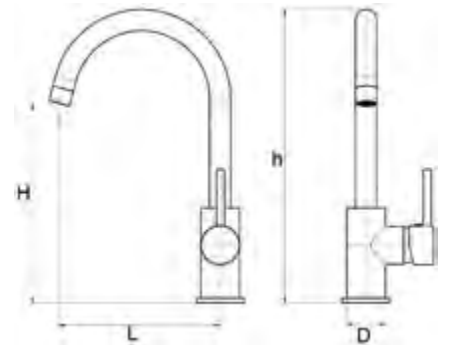

L	H	h	D	litros/min	Kg	Barcode	€
190	220	320	3/8"	7	0,8	464629	75,00

Grifo monomando sobremesa dos aguas caño frontal

Double inlet worktop mixer tap with front spout
Mitigeur de table 2 eaux avec bec frontal

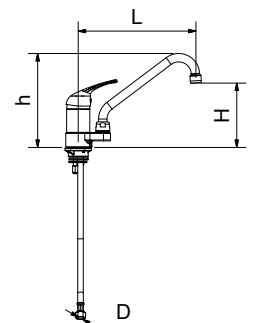

L	H	h	D	litros/min	°C	Kg	Barcode	€
253	140	200	3/8"	17	80°C	1,2	463242	93,50

Grifos giratorios sobremesa dos aguas

Double inlet rotating tap
Robinet giratoire deux eaux

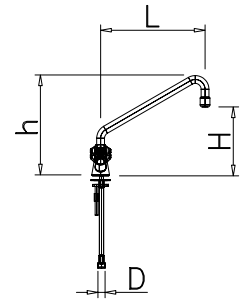

L	H	h	D				€
200	185	240	1/2"	21	1,45	463402	68,00
250	200	250	1/2"	21	1,43	463404	70,00
300	200	260	1/2"	21	1,51	463406	73,00

Grifo giratorio sobremesa dos aguas serie 1/4 de vuelta

1/4 turn model double inlet rotating tap
Robinet giratoire deux eaux modèle 1/4 de tour

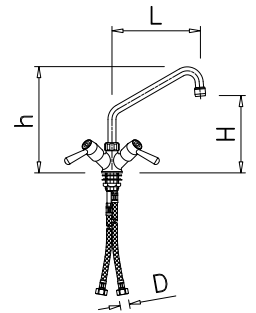

L	H	h	D				€
250	200	260	1/2"	21	1,25	463420	97,00

Grifo mezclador sobremesa con mandos 1/4 de vuelta

Quarter turn lever mixer tap
Robinet mitigeur modèle 1/4 de tour

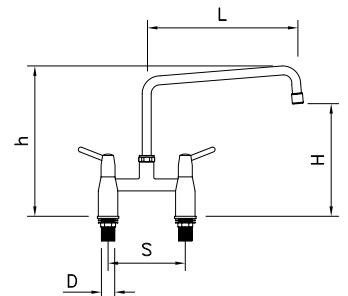

L	H	h	D	S				€
250	230	290	1/2"	155	17	1,85	463430	160,00

Grifo monomando sobremesa de codo elevado

Elevated straight spout single lever tap
Robinet monocommande à jet haut

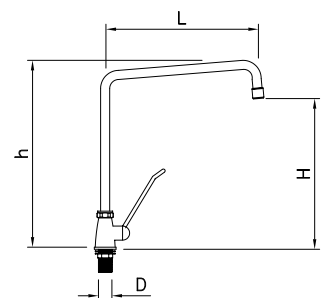

L	H	h	D				€
300	300	360	3/8"	18	1,65	463227	150,00

Grifo cocina sobremesa doble función de acero inoxidable

Stainless steel double function single lever kitchen tap
Robinet monocommande à double usage en acier inoxydable



Leva agua independiente (izquierda)
Filter lever (left side)
Manette eau speciale (a gauche)



Conducto de agua independiente
Separated pipe filter water
Conduite d'eau spéciale

Leva monomando mezcla (derecha)
Mixer level (right side)
Manette monocommande melanger (a droite)

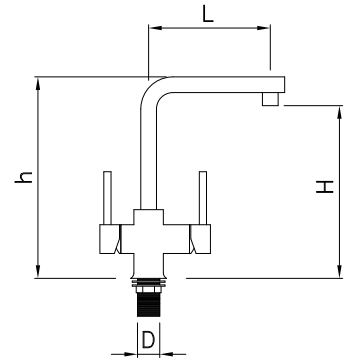

L	H	h	D	W	Kg	Barcode	€
220	280	310	1/2"	9,5	2,00	463222	121,00

Grifo giratorio extrabajo un agua

One-inlet tap, with low profile rotating spout
Robinet giratoire extra-bas à une eau

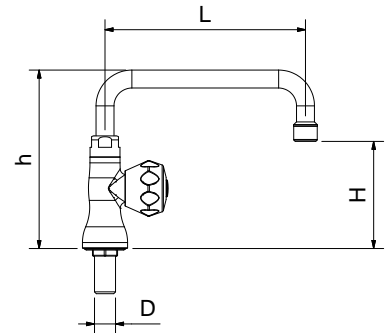

L	H	h	D	W	Kg	Barcode	€
300	110	180	1/2"	22	0,80	463438	69,00

Grifo giratorio extrabajo dos aguas

Double-inlet tap, with low profile rotating spout
Robinet giratoire extra-bas à deux eaux

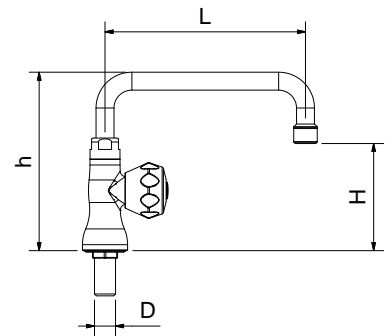

L	H	h	D	W	Kg	Barcode	€
300	55	125	1/2"	22	1,50	463440	76,00

Grifo giratorio sobremesa dos aguas 1/4 de vuelta caño bajo

Double-inlet 1/4 turn tap, with low profile rotating spout
Robinet giratoire bas 1/4 de tour à deux eaux

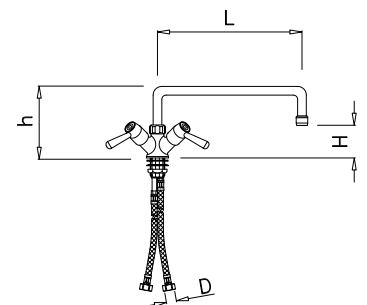

L	H	h	D	W	Kg	Barcode	€
300	70	145	1/2"	21	1,50	463422	92,00

Grifo giratorio sobremesa dos aguas serie extra bajo

Double-inlet tap, with low profile rotating spout
Robinet giratoire deux eaux modèle extra-bass

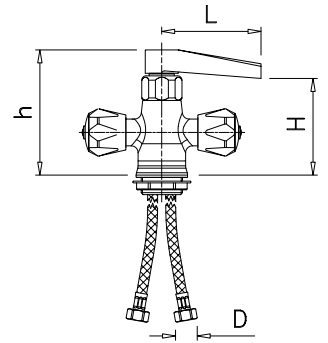

L	H	h	D				€
120	120	160	1/2"	17	2,66	463220	145,00

Grifo monomando sobremesa con caño bajo

Single lever tap, with low profile spout
Robinet monocommande jet bas

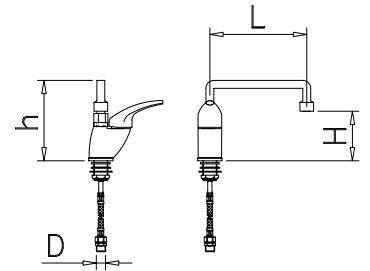

L	H	h	D				€
200	80	140	1/2"	21	1,25	463428	140,00

Grifo giratorio sobremesa 1/4 vuelta un agua caño bajo

Single inlet 1/4 turn rotating tap, low spout
Robinet tournant 1/4 tour une eau bec de robinet bas

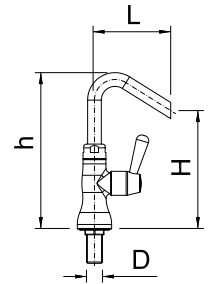

L	H	h	D				€
100	145	200	1/2"	22	1,20	463436	89,00

Grifo mural dos aguas 1/4 de vuelta caño bajo

Double inlet wall-mounted 1/4 turn tap, with low profile spout
Robinet tournant mural 1/4 tour deux eaux

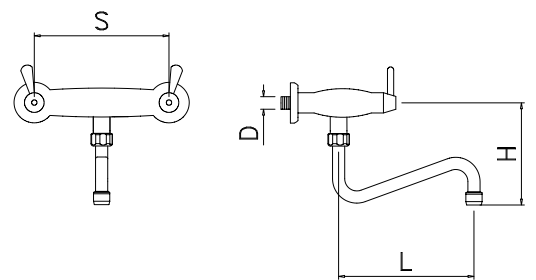

L	H	D	S				€
250	120	1/2"	150	20	1,50	463432	100,00

Grifo mural dos aguas cuarto de vuelta

Double inlet wall-mounted 1/4 turn tap
Robinet mural à deux eaux modèle 1/4 de tour

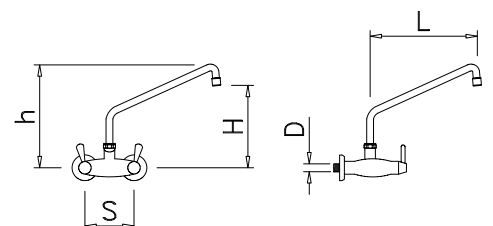

L	H	h	D	S				€
250	175	240	1/2"	150	18	1,60	463424	99,00

Grifo mural de codo un agua

Single inlet angled tap
Robinet à coude une eau

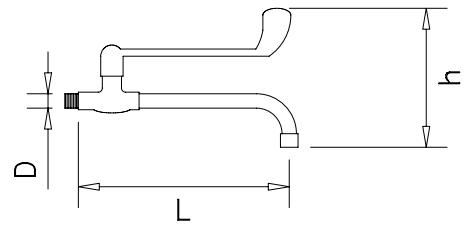

L	h	D	litros/min	Kg	Barcode	€
250	200	1/2"	25	0,65	463202	61,00

Grifo monomando mural de codo dos aguas serie monoblock-elevado

Double inlet wall-mounted single lever elbow functioning tap, high Monobloc series
Robinet de mur monocommande à coude pour deux eaux modèle monoblock-elevado

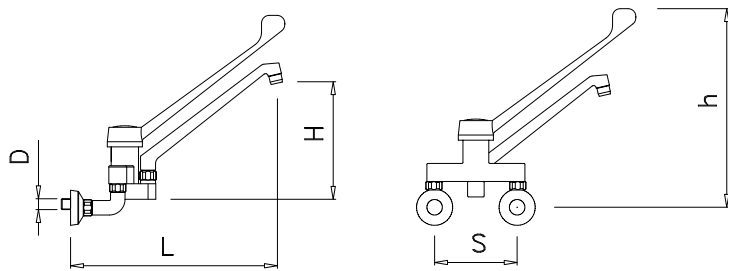

L	H	h	D	S	litros/min	Kg	Barcode	€
300	130	430	1/2"	150	22	3,89	463218	225,00

Grifo monomando mural de codo dos aguas serie monoblock-bajo

Double inlet wall-mounted single lever elbow functioning tap, low Monobloc series
Robinet mitigeur mural à coude deux eaux série monoblock-bas

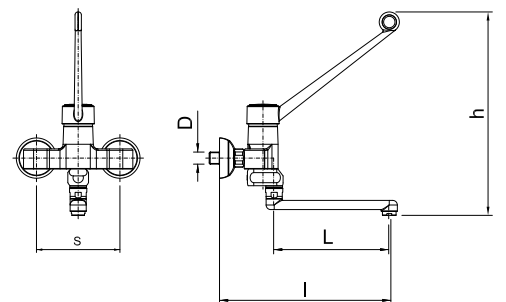

L	l	h	D	S	litros/min	Kg	Barcode	€
300	390	450	1/2"	145	20	4,50	463234	220,00

Grifo monomando mural de codo para dos aguas

Double inlet wall-mounted single lever elbow functioning tap
Robinet de mur monocommande à coude pour deux eaux

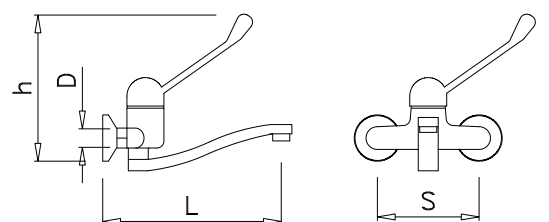

L	h	D	S	litros/min	Kg	Barcode	€
260	230	1/2"	145	20	1,48	463208	50,00

Grifo mural de 1 agua con pomo aislante caño alto
 Single inlet long-neck wall tap with insulating tap head
 Robinet mural à une eau avec tête isolante et mitigeur haut

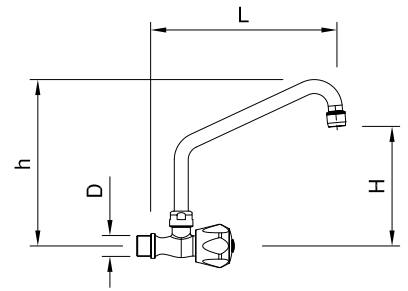

L	H	h	D	litros/min	Kg	Barcode	€
275	160	220	1/2"	25	0,60	463232	63,00

Grifo mural de 1 agua con pomo aislante caño bajo
 Single inlet low-neck wall tap with insulating tap head
 Robinet mural à une eau avec tête isolante et mitigeur bas

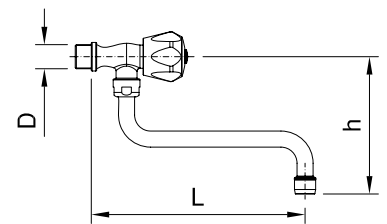

L	h	D	litros/min	Kg	Barcode	€
275	100	1/2"	25	0,60	463230	63,00

Grifo de sobremesa dos aguas con pomo aislante
 Double inlet table tap with insulating head
 Robinet sur table à deux eaux avec tête isolante

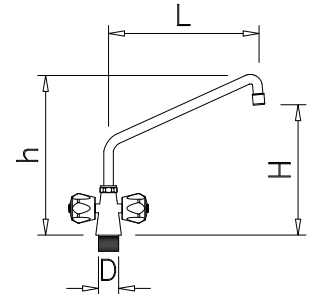

L	H	h	D	litros/min	Kg	Barcode	€
400	370	440	1/2"	18	2,90	463224	155,00

Grifo de columna orientable sobremesa pomo aislante
 Double inlet retractable pot filler tap with insulating head
 Robinet orientable sur colonne manette isolante

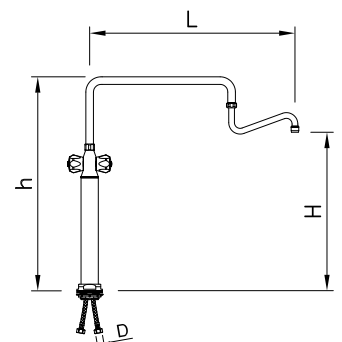

L	H	h	D	litros/min	Kg	Barcode	€
650	500	660	1/2"	23	4,00	463229	385,00

Grifo columna sobremesa 2 aguas pomo aislante

Double inlet pot filler tap with insulating head
Robinet colonne 2 eaux poignée isolante

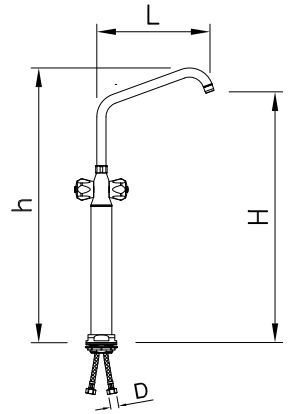

L	H	h	D	Temp	Temp	Kg	Barcode	€
300	620	700	1/2"	21	80°C	6,00	463238	355,00

Grifo de columna orientable sobremesa de un agua

One inlet retractable pot filler tap
Robinet orientable sur colonne à une eau

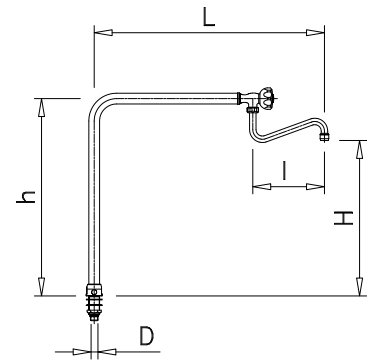

L	h	D	I	H	Temp	Kg	Barcode	€
650	550	1/2"	200	430	25	2,80	463210	166,00
700	700	1/2"	250	600	25	3,10	463212	168,00

Grifo monomando sobremesa de columna

Single lever pot filler tap
Robinet monocommande sur colonne

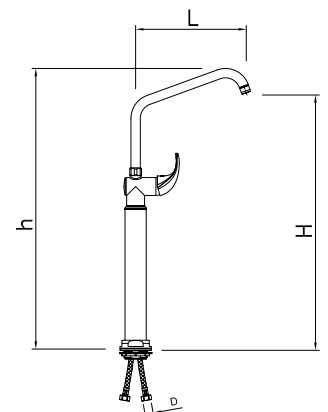

L	H	h	D	Temp	Kg	Barcode	€
285	680	750	1/2"	21	6,00	463228	280,00

Grifo de columna orientable sobremesa 2 aguas monomando

Double inlet single lever retractable pot filler tap
Robinet orientable sur colonne à deux eaux

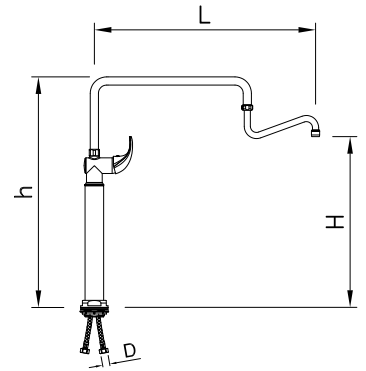

L	H	h	D				€
650	500	675	1/2"	24	5,00	463213	366,00

Válvula desagüe de 1 1/2" para marmita

1 1/2" drain for pots
Drainage de 1 1/2" pour marmites

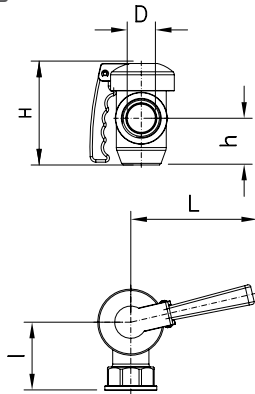

L	H	h	I	D			€
155	130	60	85	1 1/2"	2,50	464802	175,00

Válvula desagüe de 2" para marmita

2" drain for pots
Drainage de 2" pour marmites

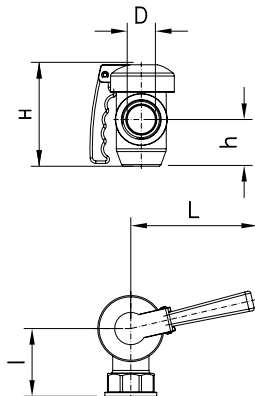

L	H	h	I	D			€
185	160	65	90	2"	2,50	464804	200,00

Válvula desagüe de 1" para marmita

1" drain for pots
Drainage de 1" pour marmites

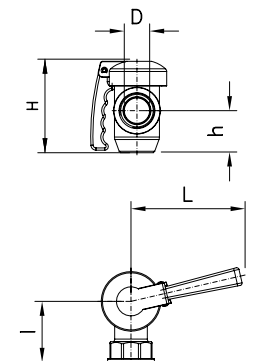

L	H	h	I	D			€
120	95	50	55	1"	1,00	464806	112,00

Grifo Clinic Expert

Expert Clinic tap
Robinet Expert Clinic



Características:

El funcionamiento "sin contacto", facilita una mayor higiene al lavarse las manos así como una fácil limpieza del lavabo. Sus materiales inhibidores de gérmenes y el enjuague higiénico ayudan a evitar la indeseable germinación. El caudal de agua libre de plomo y bacterias cumple con todas las nuevas normas de agua potable.

Characteristics:

The operation "Touchless" enables the highest hygiene when washing your hands as well as an easy clean of the basin. Its anti-sprouting materials and its hygienic shape will avoid the presence of pathogens. Lead-free and antibacterial spout that will allow the user meet the latest drinking water regulations.

Caractéristiques:

L'opération "Touchless" permet plus d'hygiène dans le lavage les mains, ainsi que un nettoyage plus facile du bassin. Ses matériaux inhibiteurs de germination et sa forme hygiénique permettra d'éviter la présence de pathogènes. Sans plomb et avec le bec antibactérien qui permet à l'utilisateur de répondre aux dernières normes de l'eau potable.

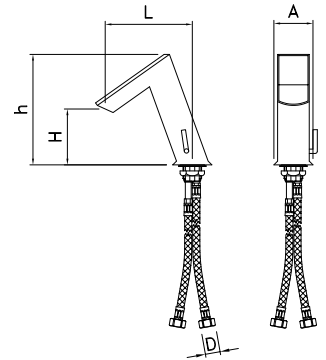

 **Funcionamiento a pilas (no incluidas)**
Batteries functioning (Not included)
Fonctionnement à piles (non inclus)

L	H	h	A	D	Kg	Barcode	€
147	94	178	63	3/8"	1,90	460809	890,00

Grifo monoblock electrónico con selector de temperatura. Funcionamiento a pilas

Electronically-operated monoblock tap with temperature selector. Battery operated

Robinet électronique monobloc avec sélecteur de température. Fonctionnement à piles



 **Funcionamiento a pilas (no incluidas)**
Batteries functioning (Not included)
Fonctionnement à piles (non inclus)

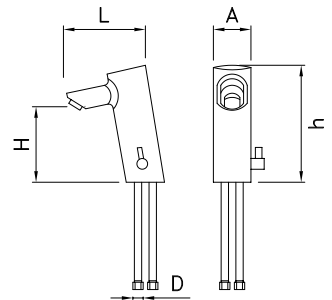

L	A	H	h	D	Water	Kg	Barcode	€
140	53	130	190	1/2"	15	3,50	460806	125,00

Grifo de cocina inteligente contactless con selector de temperatura

Smart contactless kitchen faucet with temperature adjustment

Robinet de cuisine intelligent sans contact avec sélecteur de température



 **Funcionamiento a pilas (no incluidas)**
Batteries functioning (Not included)
Fonctionnement à piles (non inclus)

Video

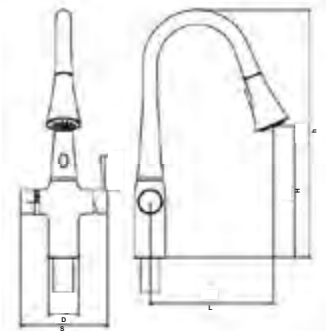

L	H	h	S	Water	Kg	Barcode	€
210	230	426	150	6,3	3,50	460804	327,00

Grifo de sobremesa electrónico
 Electronically battery-operated tap
 Robinet sur table électronique

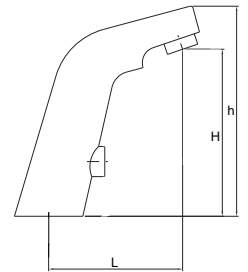

L	H	h					€
98	122	154	15	60	1,80	460802	224,00

Grifo sobremesa electrónico de acero inoxidable
 Stainless steel electronically-operated faucet, high spout
 Robinet électronique col de cygne haut d'acier inoxydable



Funcionamiento a pilas (no incluidas)
 Batteries functioning (Not included)
 Fonctionnement a piles (non inclus)

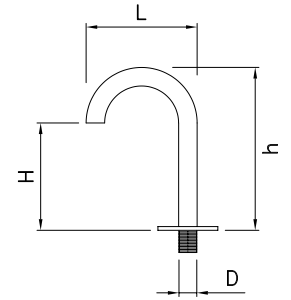

L	H	h	D				€
125	125	220	1/2"	15	3,00	060804	135,00

Grifo mural electrónico. Funcionamiento a pilas
 Electronically-operated wall tap. Battery operated
 Robinet électronique au mur. Fonctionnement à piles



Funcionamiento a pilas (no incluidas)
 Batteries functioning (Not included)
 Fonctionnement a piles (non inclus)

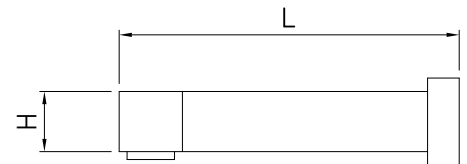

L	H	D				€
220	35	1/2"	15	1,20	460808	171,00

Caño fijo
 Fixed spout
 Jet fixe

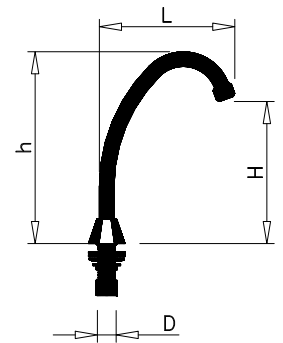

L	H	h	D			€
130	180	245	1/2"	420	461002	55,00

Caño giratorio de acero inoxidable
 Stainless steel rotating spout
 Jet giratoire d'acier inoxydable

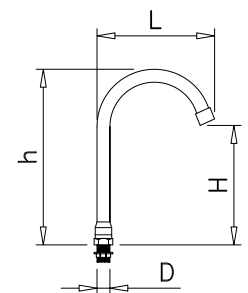

L	H	h	D			€
180	180	270	1/2"	246	461008	42,00

Caño giratorio extra bajo

Low profile rotating spout
Giratoire extra bas

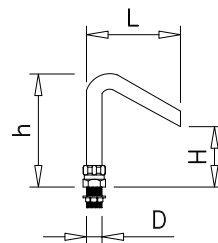

L	h	D	H	Gr	Barcode	€
113	130	1/2"	70	280	461010	47,00

Caño ducha extraible

Pull-out sprayer spout
Jet detachable pour douche



Longitud del latiguillo 1.200 mm.
Hose length 1,200 mm.
Longueur du flexible 1.200 mm.

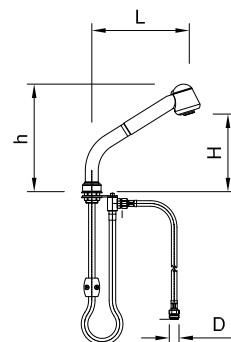

L	H	h	D	litros/min	Kg	Barcode	€
210	167	230	3/8"	18	1,00	462862	180,00

Caño mural giratorio

Wall-mounted rotating spout
Jet mural giratoire

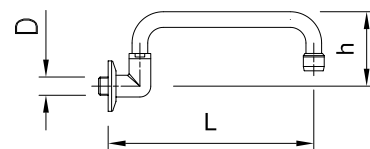

L	h	D	litros/min	Gr	Barcode	€
330	110	1/2"	17	350	461012	65,00

Aireador cromado fijo para grifo

Fixed Chrome aerator for tap
Aérateur chromé fixe pour robinet

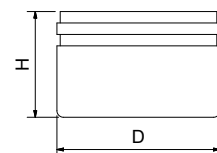

H	D	litros/min	Gr	Barcode	€
14,5	24	15	50	461016	1,80

Aireador cromado orientable para grifo

Pivoting Chrome aerator for tap
Aérateur chromé réglable pour robinet

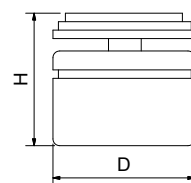

H	D	litros/min	Gr	Barcode	€
35	24	15	105	461018	6,00

Pedal mezclador de agua fría y caliente con palanca de bloqueo H-H-H- 1/2"

H-H-H 1/2" hot and cold water mixer pedal with blocking lever
Pédale mélangeuse eau froide et chaude H-H-H 1/2" avec levier de blocage



L	A	H	Kg	Barcode	€
350	100	93	2,70	460606	225,00

Pedal de un agua M-M de 1/2"

M-M 1/2" single inlet water pedal
Pédale à une eau M-M 1/2"

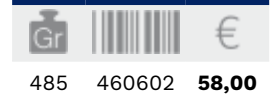

Pedal mezclador de agua fría y caliente M-M-M de 1/2"

M-M-M 1/2" hot and cold-water mixer pedal
Pédale mélangeuse eau froide et eau chaude M-M-M 1/2"



Pulsador no temporizado M-M de 1/2"

M-M 1/2" self-closing momentary push button
Bouton-poussoir non temporisé M-M 1/2"

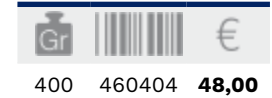

Pulsador temporizado M-M de 1/2"

M-M 1/2" self-closing push button timer
Bouton-poussoir temporisé M-M 1/2"



Palanca un agua M-M 1/2"

M-M 1/2" self closing lever valve
Robinet à levier M-M 1/2"



Válvula mezcladora termostática H-H-M de 1/2"

H-H-M 1/2" thermostatic mixing valve
Valve mélangeuse thermostatique H-H-M 1/2"

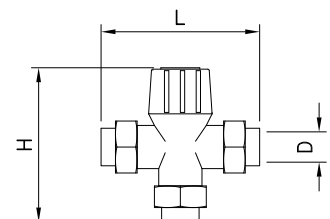

Válvula mezcladora antiretorno M-H-M de 1/2"

M-F-M 1/2" no-return mixing valve
Valve mélangeuse antiretour M-H-M 1/2"

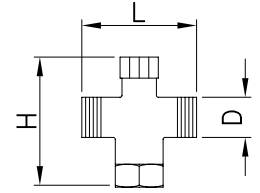

L	H	D	Gr	Barcode	€
60	70	1/2"	150	461604	26,25

Grifo pulsador para fuente

Push-button tap for fountain
Robinet poussoir pour fontaine

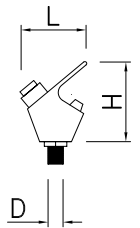

L	H	D	Push-button	Gr	Barcode	€
65	85	3/8"	10	125	464250	26,00

Grifo para fuente de agua sin pulsador

Tap for drinking fountain without push-button
Robinet pour fontaine sans bouton-poussoir

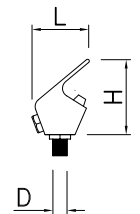

L	H	D	Push-button	Gr	Barcode	€
50	70	3/8"	10	115	464248	25,00

Grifo electrónico inoxidable a pilas para fuente de agua 1/2"

Electronic battery-powered faucet 1/2" in stainless steel for drinking fountain
Robinet électronique à pile en acier inoxydable pour fontaine à eau 1/2"



Novedad
en
Faucet



Funcionamiento a pilas
(no incluidas)
Batteries functioning
(Not included)
Fonctionnement a piles
(non inclus)

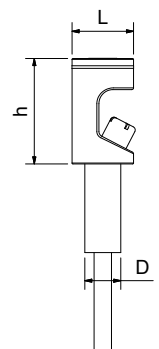

L	h	D	Push-button	Gr	Barcode	€
35	60	1/2"	8	460	464258	234,00

Grifo llenajarras

Bottle filler for drinking fountain
Robinet pour remplir pots

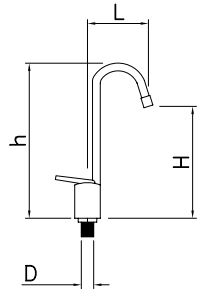

L	H	h	D	litros	Gr	Barcode	€
75	140	220	3/8"	8	130	464252	21,00

Grifo llenajarras de acero inoxidable

Stainless steel bottle-filler tap
Robinet de remplissage de pichet d'acier inoxydable



Novedad
nouveau

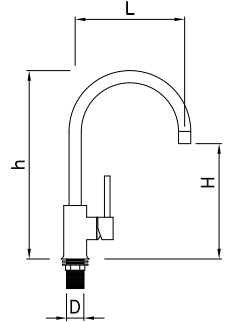

L	H	h	D	Kg	Barcode	€
150	210	275	1/2"	0,13	464256	50,00

Grifo llenajarras electrónico acero inoxidable para fuente de agua

Stainless steel electronic bottle-filler tap for drinking fountain
Robinet de remplissage de pichet électronique en acier inoxydable pour fontaine à eau



Funcionamiento a pilas
(no incluidas)
Batteries functioning
(Not included)
Fonctionnement a piles
(non inclus)

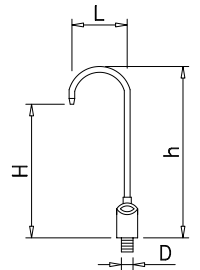

L	H	h	D	Gr	Barcode	€
100	225	295	1/2"	310	464254	265,00

Ducha de gran alcance H de 1/2"

Long-reach shower
Douche à grande portée



Longitud del latiguillo 2.000 mm.
Hose length 2.000 mm.
Longueur du flexible 2.000 mm.

litros	°C	Gr	Barcode	€
13,5	60°C	900	463002	27,00

Ducha horno H de 1/2"

Shower for oven
Douche pour four



Longitud del latiguillo 2.000 mm.
Hose length 2.000 mm.
Longueur du flexible 2.000 mm.

litros	°C	Kg	Barcode	€
11	60°C	2,45	463004	78,00

Ducha horno enrollable H de 1/2"

Roll-up shower for oven
Douche pour four enrollable

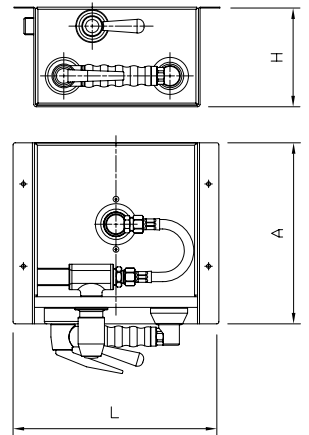

Longitud del latiguillo 1.700 mm.
Hose length 1.700 mm.
Longueur du flexible 1.700 mm.

L	A	H					€
250	220	115	10	55°C	5,00	463006	339,00

Ducha horno enrollable bajo encimera

Under worktop roll-up shower for oven
Douche enrollable sous plan pour four

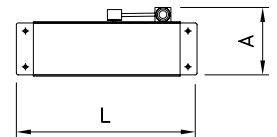

Longitud del latiguillo 1.700 mm.
Hose length 1.700 mm.
Longueur du flexible 1.700 mm.

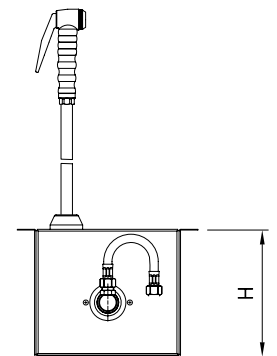

L	A	H	D					€
230	108	200	1/2"	13	55°C	4,00	463008	295,00

Ducha para horno pulsador

Shower for oven, push button operation
Douche pour four, fonctionnement à poussoir



Longitud del latiguillo 2.000 mm.
Hose length 2.000 mm.
Longueur du flexible 2.000 mm.

				€
11	60°C	2,50	463005	63,00

Soporte para manguera en acero inoxidable

Stainless steel hose holder
Support pour tuyau en acier inoxydable

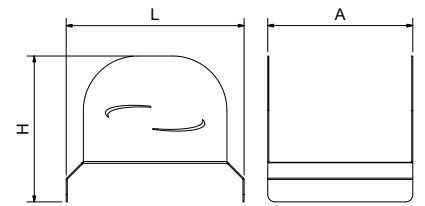

L	A	H	Kg	Barcode	€
245	200	200	1,40	064020	33,00

Grifo manguera 50 m. con soporte inox y pistola

50 m. faucet hose with stainless steel holder and wash gun
Robinet tuyau 50 m. avec support inox et pistolet



Longitud de manguera: 50 mts.
Hose length: 50 mts.
Longueur du tuyau: 50 mts.



Kg	Barcode	€
14,50	064022	344,00

Grifo manguera enrollable serie profesional

Roll-up faucet hose, professional series
Robinet-tuyau d'arrosage enrollable professionnel



Longitud de manguera: 13 mts.
Hose length: 13 mts.
Longueur du tuyau: 13 mts.

El precio NO incluye el grifo rociador o piña.
Faucet not included in the price.
Le prix ne inclut pas le robinet d'arrosage.

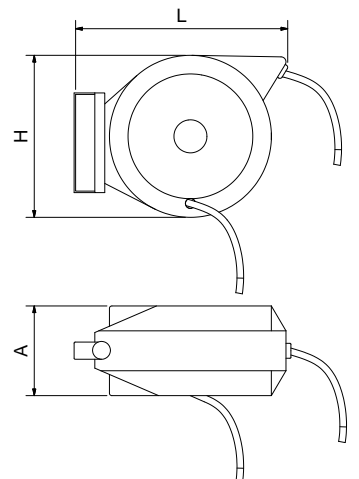

* Se incluye conexión de 1/2" M.
1/2" M link included.
Comprend adaptateur 1/2" M.

L	A	H	Ø	Water	Temp	Kg	Barcode	€
390	175	300	3/8" *	12	55 °C	7,00	064006	196,00

Grifo manguera enrollable inoxidable serie compacto

Inox roll-up faucet hose, compact series
Robinet enrouleur inoxydable série compacte



Longitud de manguera: 5 mts.
Hose length: 5 mts.
Longueur du tuyau: 5 mts.

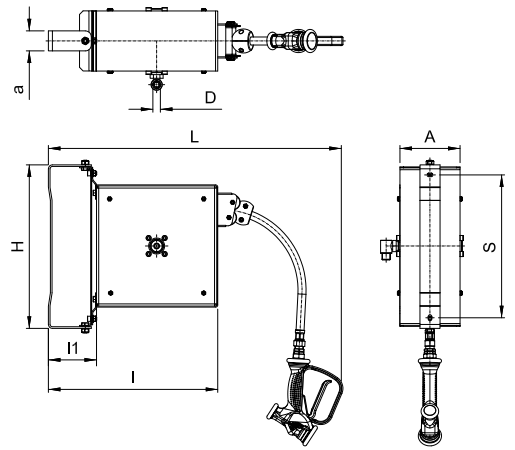

L	I	H	D	S	A	a	I1	Wt	Kg	Barcode	€
730	425	410	1/2"	356	150	50	120	13	11,00	464008	1.099,00

Grifo manguera enrollable serie profesional plus

Professional plus roll-up faucet hose
Robinet enrouleur professionnel plus



Longitud de manguera: 5 mts.
Hose length: 5 mts.
Longueur du tuyau: 5 mts.

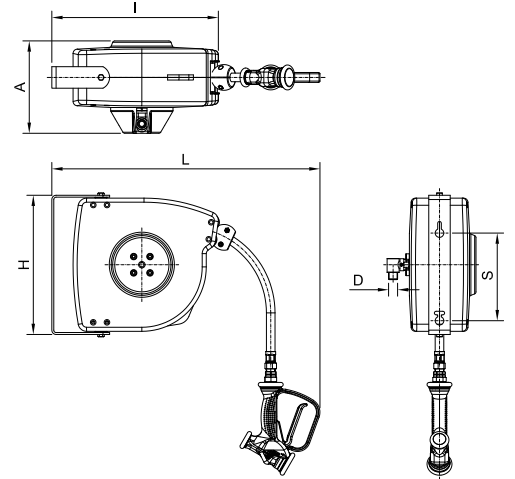

L	I	H	D	S	A	Wt	Kg	Barcode	€
620	390	320	1/2"	204	215	13	7,00	464010	899,00

Puesto de lavado y desinfección

Sanitising and disinfectant spray system
Poste de lavage et de désinfection



Características:

Soporte inox. para 1 garrafa de 5 litros.

Characteristics:

Inox holder for 5 litres tank

Caractéristiques:

Support inox pour réservoir de 5 litres



Longitud de manguera: 15 mts.
Hose length: 15 mts.
Longueur du tuyau: 15 mts.

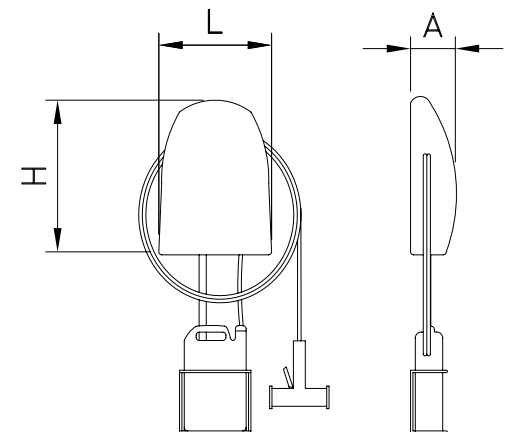

L	A	H	Kg	Barcode	€
350	120	480	2,60	465602	550,00

Grifo manguera enrollable serie básico

Basic roll-up faucet hose

Robinet-tuyau d'arrosage enrollable basique

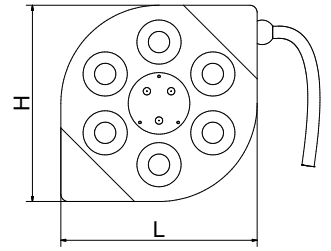
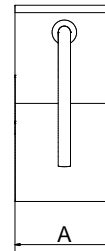

Longitud de manguera: 20 mts.
Hose length: 20 mts.
Longueur du tuyau: 20 mts.

L	A	H	∅	Temp	Temp	Kg	Barcode	€
400	200	400	1/2"	12	40°C	11,50	464006	205,00

Grifo manguera enrollable serie inoxidable

Stainless roll-up faucet hose

Robinet-tuyau d'arrosage enrollable inoxydable



Construcción en acero inoxidable extrafuerte
Pivotante 180°
Máxima presión 5 bar

All heavy duty stainless steel construction
180° pivoting
Max. press. 5 bar

Construit en acier inoxydable extra-fort
Pivotement 180°
Max. press. 5 bar

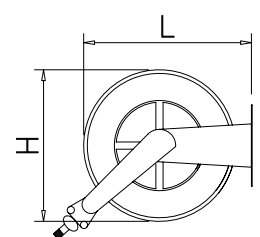
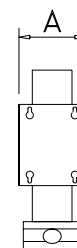

Longitud de manguera: 15 mts.
Hose length: 15 mts.
Longueur du tuyau: 15 mts.











El precio incluye el grifo rociador o piña.
Faucet included in the price.
Le prix inclut pas le robinet d'arrosage.

L	A	H	∅	Temp	Temp	Kg	Barcode	€
533	235	438	1/2"	13	55°C	22,00	464004	1.162,00

Accesorios para grifos de manguera

Taps accessories for roll-up faucets

Robinetterie accessoires pour robinet-tuyau d'arrosage

			Gr	Barcode	€
	Adaptador H de 3/8" a M de 1/2" M 3/8" to F 1/2" adaptor Adaptateur M 3/8" - H 1/2"	50	464055	4,00	
	Adaptador H de 1/2" a H de 1/2" F 1/2" to F 1/2" adaptor Adaptateur H 1/2" - H 1/2"	60	464054	4,50	
	Conector rápido universal H1/2" F 1/2" Universal quick connector Connecteur rapide universel F 1/2"	75	464062	33,00	
	Pistola rociadora de pulverización regulable H 1/2" Gun shower F 1/2" Pistolet H 1/2"	970	464058	132,00	
	Pistola con lanza rociadora H 1/2" Pistol and nozzle shower F 1/2" Pistolet et lance F 1/2"	615	064050	140,00	
	Piña para grifo ducha Head shower Douche	700	462806	83,00	
	Piña de acero inoxidable para grifo ducha Stainless steel head shower Douche d'acier inoxydable	700	462807	130,00	
	Piña para grifo ducha serie Ecológica Shower head for pre-rinse unit Eco series Poignée pour robinet douchette série Écologique	700	462890	114,00	
	Piña de repuesto para grifo de accionamiento extensible Spare head shower for faucet with extendable shower Poignée de remplacement pour robinet à actionnement extensible	280	462872	77,00	
	Equilibrador Spring balancer Équilibrateur	500	463030	70,00	

Monomando lavabo

Single lever mixer for basin
Mélangeur lavabo

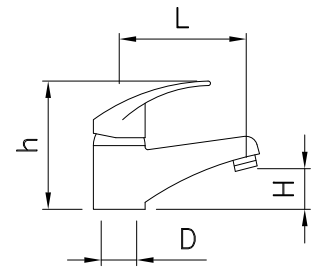

L	H	h	D	Water tap icon	Gr	Barcode	€
110	44	111	3/8"	16	570	464616	39,00

Grifo monomando para lavabo serie Ecológica

Single lever mixer for basin, Eco series
Mélangeur de lavabo série écologique

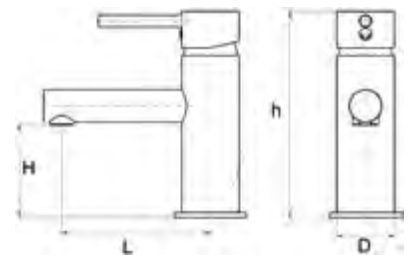

L	H	h	D	Water tap icon	Gr	Barcode	€
120	71	160	3/8"	7	890	464625	66,00

Grifo para lavabo de 1 agua

One inlet basin tap
Robinet pour lavabo à une eau

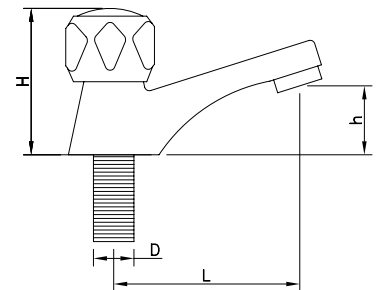

L	H	h	D	Water tap icon	Gr	Barcode	€
80	75	35	1/2"	16	0,25	464608	19,00

Monomando bidé

Single lever mixer for bidet
Mélangeur bidet

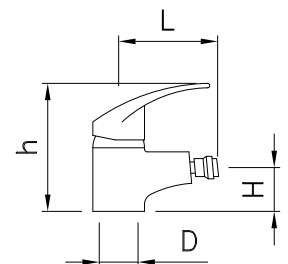

L	H	h	D	Water tap icon	Gr	Barcode	€
95	42	114	3/8"	16	580	464618	39,00

Grifo monomando para bidé serie Ecológica

Single lever mixer for bidet. Eco series
Mélangeur de bidet série écologique

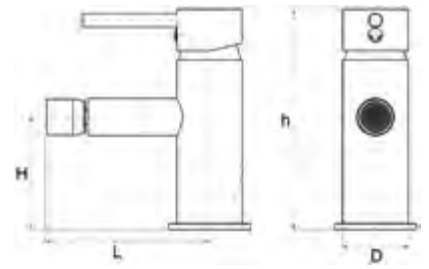

L	H	h	D	Wc mm	Gr	Barcode	€
120	75,5	150	3/8"	7	826	464626	66,00

Grifo temporizado un agua

One inlet timer tap
Robinet temporisé à une eau

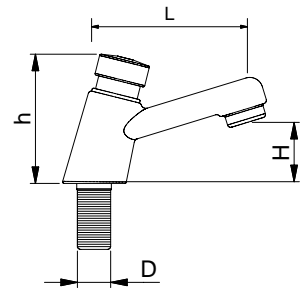

L	H	h	D	Wc mm	Kg	Barcode	€
100	30	80	1/2"	0,67	0,67	464602	64,00

Grifo temporizado dos aguas

Double inlet timer tap
Robinet temporisé à deux eaux

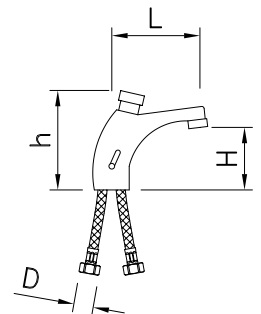

L	H	h	D	Wc mm	Kg	Barcode	€
107	85	125	1/2"	15	1,25	464612	188,00

Monomando ducha

Single lever mixer for shower
Mélangeur douche

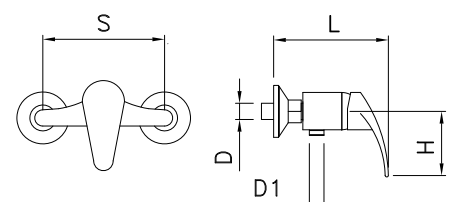

L	H	D	D1	S	Wc mm	Gr	Barcode	€
130	85	1/2"	1/2"	150	17	684	464622	53,00

Grifo monomando para ducha serie Ecológica

Single lever mixer for shower. Eco series
Mitigeur de douche série écologique

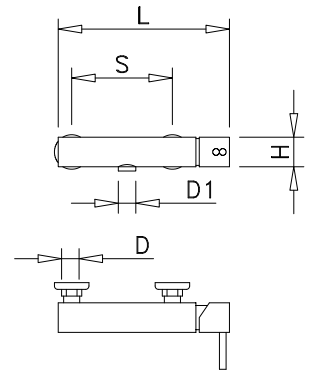

L	H	D	D1	S				€
255	44	1/2"	1/2"	150	7	1,16	464628	100,00

Monomando baño/ducha

Single lever mixer for bath/shower
Mélangeur baignoire

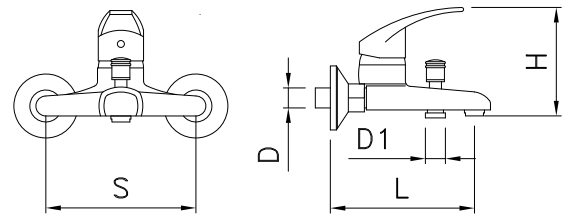

L	H	D	D1	S				€
144	111	1/2"	1/2"	150	17	888	464620	66,00

Grifo monomando para baño/ducha serie Ecológica

Single lever mixer tap for bath/shower. Eco series
Mitigeur de baignoire/douche série écologique

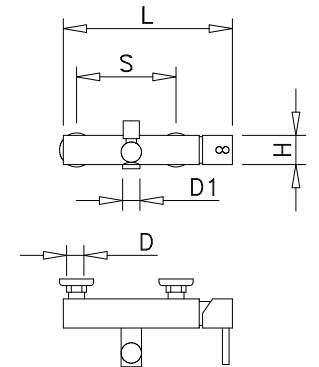

L	H	D	D1	S				€
255	44	1/2"	1/2"	150	7	1,56	464627	127,00

Conjunto de ducha, grifo monomando y mástil

Wall-mounted rainfall tub shower tap set
Ensemble robinet douche mitigeur fixation mural

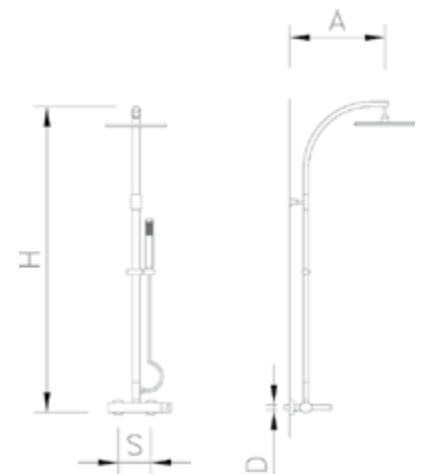

A	H	S	D				€
385	1.300	150	1/2"	6	4,00	465802	472,00

Conjunto de ducha y pulsador profesional

Professional push-button shower set
Ensemble douche bouton-poussoir professionnelle

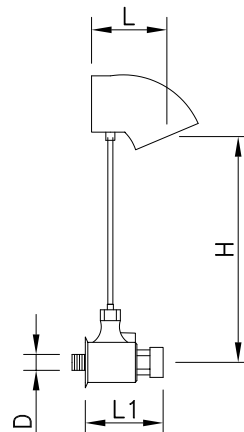

L	L1	H	D	litros/min	°C	Kg	Barcode	€
115	80	860	1/2"	5	80°C	1,80	465804	180,00

Rociador de ducha

Shower sprayer
Pomme de douche

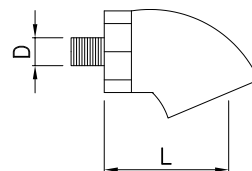

L	D	litros/min	°C	Gr	Barcode	€
60	1/2"	5	80°C	450	465806	41,00

Ducha higiénica con llave de paso

Hygienic shower with stopcock
Douche hygiénique avec robinet



Novedad
est.
Nouveauté

Características:

Esta ducha higiénica con selector monomando es el sustituto ideal para el bidé y la escobilla.

Gracias a su tamaño es perfecta para espacios pequeños y su instalación al lado del inodoro será discreta a la par que útil.

Incorpora un selector monomando y un latiguillo de 1,20m para facilitar su utilización.

Characteristics:

This hygienic shower with a single-lever selector is the ideal substitute for the bidet and the toilet brush. Thanks to its size, it is perfect for small spaces and its installation next to the toilet will be discreet as well as useful. It is supplied with a 1.20m hose for easy use.

Caractéristiques:

Cette douche hygiénique avec sélecteur monocommande est le substitut idéal du bidet et de la brosse WC. Grâce à sa taille, il est parfait pour les petits espaces et son installation à côté des toilettes sera aussi discrète qu'utile. Il intègre un sélecteur monocommande et un tuyau de 1,20 m pour faciliter son utilisation.

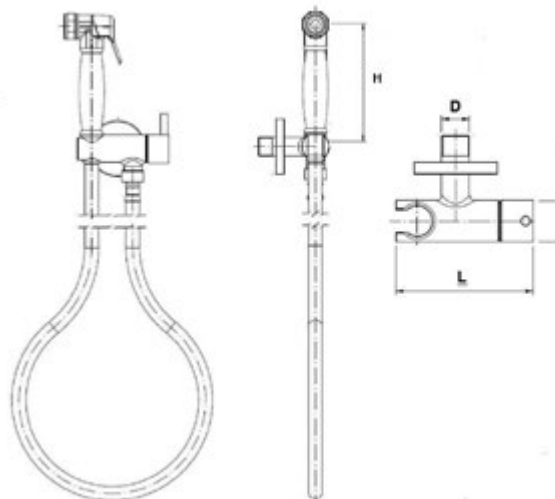

L	H	D	litros/min	Gr	Barcode	€
98,5	36	1/2"	15	812	464614	152,00

Ducha higiénica serie basic

Basic series hygienic shower
Douche hygiénique série Basic



Características:

Esta ducha higiénica de diseño sencillo es el sustituto ideal para el bidé y la escobilla.

Gracias a su tamaño es perfecta para espacios pequeños y su instalación al lado del inodoro será discreta a la par que útil.

Incorpora el latiguillo de 1,20m para facilitar su utilización.

Characteristics:

This simply designed hygienic shower is the ideal substitute for the bidet and toilet brush. Thanks to its size, it is perfect for small spaces and its installation next to the toilet will be discreet as well as useful. It is supplied with a 1.20m hose for easy use.

Caractéristiques:

Cette douche hygiénique au design simple est le remplacement idéal d'un bidet et d'une brosse WC.

Grâce à sa taille, il est parfait pour les petits espaces et son installation à côté des toilettes sera aussi discrète qu'utile. Il intègre le tuyau de 1,20 m pour faciliter son utilisation.

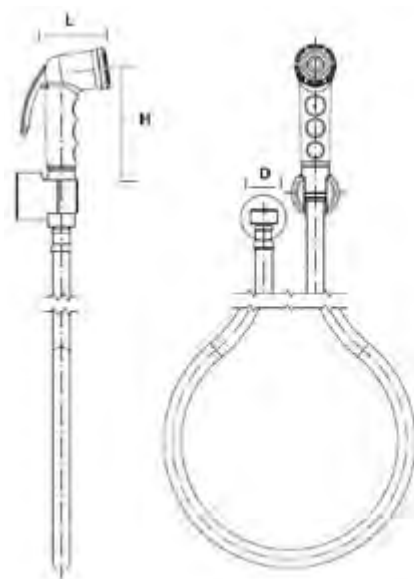

L	H	D	Unit	Gr	Barcode	€
55	84,25	1/2"	15	320	464615	47,00

Fluxómetro para WC

Flush valve push button for toilets
Robinet temporise pour WC

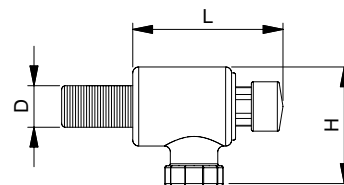

L	H	D	Gr	Barcode	€
100	80	3/4"	900	464606	96,00

Grifo temporizado para urinario

Flush valve push button for urinals
Robinet temporise pour urinoirs

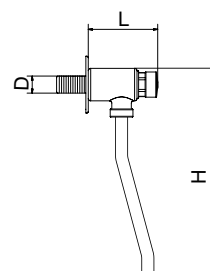

L	H	D	Gr	Barcode	€
72	210	1/2"	400	464604	49,00

Grifo electrónico temporizado para urinario. Funcionamiento a pilas

Sensor operated flush valve for urinals
Robinet électronique temporisé pour urinoirs. Fonctionnement à piles



Funcionamiento a pilas
(no incluidas)
Batteries functioning
(Not included)
Fonctionnement à piles
(non inclus)

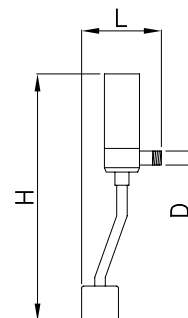



























L	H	D	Kg	Barcode	€
85	310	1/2"	1,20	464610	199,00













Repuestos para grifos













Spare parts for taps











Pièces de remplacement pour robinets

		Modelo Model Model	Gr	Barcode	€	
	Piña para grifo ducha Head shower Douche		700	462806	83,00	
	Piña de acero inoxidable para grifo ducha Stainless steel head shower Douche d'acier inoxydable		700	462807	130,00	
	Piña para grifo ducha serie Ecológica Shower head for pre-rinse unit Eco series Poignée pour robinet douchette série Écologique		700	462890	114,00	
	Piña de repuesto para grifo de accionamiento extensible Spare head shower for faucet with extendable shower Poignée de remplacement pour robinet à actionnement extensible		280	462872	77,00	
	Juego de muelle y juntas para piña de grifo ducha Spring and joints set for shower head Ensemble de ressort et joints pour poignée de robinet douchette		30	462880	10,00	
	Latiguillo inox. plastificado para grifo ducha Flexible rubber hose inox for shower taps Flexibles en d'acier inoxydable pour robinet douche	800 mm	250	462851	22,00	
		1.100 mm	350	462808	18,00	
		1.200 mm	350	462852	23,00	
		1.500 mm	360	462854	25,00	
		2.000 mm	370	462810	27,00	
	Latiguillos flexibles en malla de acero inoxidable H-H de 1/2" H-H 1/2" stainless-steel flexible hoses Flexibles en maille d'acier inoxydable H-H d'1/2"	400 mm	100	461202	5,25	
		600 mm	120	461206	6,30	
		900 mm	200	461212	8,40	
		1.200 mm	240	461214	7,88	
		1.500 mm	345	461216	9,45	
	Latiguillo de repuesto para grifo 463052 Spare hose for faucet 463052 Tuyau de rechange pour robinet 463052		850 mm	220	463084	25,00
	Latiguillo de repuesto para grifo 463220 Spare hose for faucet 463220 Tuyau de rechange pour robinet 463220		160	463256	14,50	
	Muelle para grifo ducha Spring for table shower fitting Ressort pour robinet douche		1.200	462804	36,00	
	Mástil para grifo ducha Table shower fitting support Tuyau pour robinet douche	790 mm	930	462802	47,00	
		620 mm	800	462800	45,00	
	Mástil extra corto para grifo ducha Extra-short table shower fitting support Tuyau extra court sur table pour robinet douchew		210 mm	270	462801	35,00

					Modelo Model Model	Gr	€
	Mástil con caño para grifo ducha Table shower fitting support with spout Tuyau pour robinet douche avec jet	790 mm	1.360	462803			113,00
	Pomo de repuesto para mástil con caño Spare flow knob for table shower fitting support Sélecteur de sortie pour robinet douchette					120 462875	15,00
	Tope de muelle para grifo ducha Top for table shower fitting spring Arrêt pour robinet douche					140 462805	7,00
	Tirante, soporte a pared para grifo ducha + soporte piña Wall-rod for shower fitting + shower-head holder Tringle au mur pour robinet douchette + Tringle au mur pour robinet douche					350 462814	26,00
	Soporte piña modelo apoyar Shower-head holder. Supporting model Support pour poignée. Modèle appui					220 462876	26,00
	Tirante a pared para grifo ducha 463052 Wall-rod for shower fitting 463052 Tringle au mur pour robinet douche 463052					130 462848	35,00
	Repuesto de tirante a pared y soporte para piña para grifos 463080 y 463081 Spare wall support for shower fitting and holder shower head holder for taps 463080 y 463081 Support mural et support poignée de rechange pour robinets 463080 et 463081					495 462882	65,00
	Tornillo allen M6x12 (tope de muelle y tirante a pared) Allen bolt M6x12 (spring top and wall rod) Vis allen M6x12 (arrêt pour robinet et tringle au mur)					2 462824	0,45
	Tornillo allen M6x8 (Soporte piña) Allen bolt M6x8 (shower head support) Vis allen M6x8 (support de pomme)					1 462826	0,45
	Bolsa de tornillería y juntas (repuesto) para grifo ducha Bag with screws and gaskets (spare) for shower tap Sachet de vis et joints (de rechange) pour robinet douchette					10 462827	8,00
	Tuerca unión mástil y válvula grifo ducha Joint nut for shower fitting support and shower tap valve Écrou de joint pour tuyau et valvule pour robinet douche					40 462816	3,50
	Juego de juntas para el mástil del grifo ducha Joints set for shower fitting support Conjoint de joints pour tuyau de robinet douche					1 462834	2,10
	Conjunto sujeción inferior válvula de un agua Lower fixing set for single inlet valve Conjoint de fixation inférieure pour valvule à une eau					35 462836	4,20
	Conjunto sujeción inferior válvula monomando dos aguas Lower fixing set for double inlet one handle valve Conjoint de fixation inférieure pour valvule monocommande à deux eaux					30 462840	5,50

	Conjunto sujeción inferior válvula dos aguas Lower fixing set for double inlet valve Conjoint de fixation inférieure pour valvule à deux eaux	85	462838	4,50
	Conjunto sujeción inferior para válvula 462406 Lower fixing set four double inlet one handle valve Conjoint de fixation inférieure pour valvule mitigeur à deux eaux	95	462841	15,00
	Acoplamiento de grifo ducha serie basic a encimera Countertop fixing for basic series shower tap Raccord de robinet douchette de la série basic au plan de travail	165	462856	19,00
	Latiguillo inferior para grifo ducha dos aguas Lower hose for table double inlet shower fitting Flexible intérieur pour robinet douche à deux eaux	90	462820	8,50
		95	462822	8,50
	Palanca para válvula monomando dos aguas Handle for double inlet one handle valve Commande pour valvule monocommande à deux eaux	130	462842	11,00
	Palanca repuesto para válvulas 462412, 462408, 463206 Handle for 462412, 462408 and 463206 valves Commande pour valvule 462412, 462408, 463206	145	463260	23,00
	Leva de repuesto para grifo monomando sobremesa 463242 Spare lever for worktop mixer tap 463242 Lever de rechange pour mitigeur de table 463242	150	463264	19,00
	Caño bajo de 200mm. para válvulas 200 mm. low spout for valves 200mm. jet bas pour valves	250	462866	30,00
	Caño bajo de repuesto para grifo monoblock 463234 Spare low spout for monoblock tap 463234 Bec bas de rechange pour robinet monoblock 463234	270	463262	68,00
	Caño para válvula monomando dos aguas Spout for connecting to one handle mounted valve Jet adaptable au robinet monocommande à deux eaux	530	462844	56,00
	Caño acoplable a mástil de grifo ducha 250mm. Attachable spout for shower fitting support 250mm. Jet adaptable à tuyau pour robinet douche 250mm.	430	462850	37,00
	Caño acoplable a mástil de grifo ducha 200mm. Attachable spout for shower fitting support 200mm. Jet adaptable à tuyau pour robinet douche 200mm.	462849		34,00
	Caño acoplable a grifo ducha Spout for shower fitting Bec de robinet adaptable à douchette	1.200	462813	96,00

	<p>Caño negro de repuesto para grifo 464632 Spare black spout for tap 464632 Bec noir de rechange pour robinet 464632 464636</p>	360	464636	86,00
	<p>Caño blanco de repuesto para grifo 464633 Spare white spout for tap 464633 Bec blanc de rechange pour robinet 464633</p>	360	464637	86,00
	<p>Caño 200 mm. de repuesto para grifo monomando sobremesa 463242 Spare 200 mm spout for worktop mixer tap Bec 200 mm. pièce de rechange pour mitigeur sur table 463242</p>	150	463266	50,00
	<p>Válvula doble entrada, dos aguas 1/4 vuelta Double inlet valve for deck mounted faucet, 1/4 turn Valve double entrée, 2 eaux 1/4 de tour</p>	1.600	462418	180,00
	<p>Válvula doble entrada, dos aguas, monomando codo Double inlet single lever high neck valve, elbow functioning Valve double entrée, 2 eaux, mélangeur à coude</p>	4.000	462420	355,00
	<p>Válvula monomando dos aguas Double inlet single lever valve Valve monocommande à deux eaux</p>	2.400	462406	194,00
	<p>Pomo corto para válvula 462406 Spare flow knob for table shower fitting support Sélecteur de sortie pour robinet douchette</p>	86	462874	16,00
	<p>Válvula monomando dos aguas Double inlet single lever valve Valve monocommande à deux eaux</p>	963	462410	121,00
	<p>Válvula monomando dos aguas Double inlet single lever tap Valve monocommande à deux eaux</p>	1.800	462412	147,00
	<p>Válvula mural monomando dos aguas Wall-mounted single lever valve Valve monocommande de mur à deux eaux</p>	1.750	462408	161,00
	<p>Válvula monomando mural de codo monoblock para grifo ducha Single lever wall-mounted monobloc valve, elbow functioning Robinet mono-commande mural à coude monobloc pour robinet douchette</p>	1.600	462422	373,00
	<p>Válvula mural dos aguas con levas 1/4 de vuelta Double inlet 1/4 turn wall-mounted valve Valve murale avec pommes 1/4 de tour</p>	1.900	462416	78,00
	<p>Válvula dos aguas con levas 1/4 de vuelta Double inlet 1/4 turn valve Valve avec pommes 1/4 de tour</p>	1.500	462414	81,00

	Pomo rojo para válvula 462414 y 462416 Red spare flow knob for table shower fitting support Sélecteur rouge de sortie pour robinet douchette	86	462884	19,00
	Pomo azul para válvula 462414 y 462416 Blue spare flow knob for table shower fitting support Sélecteur bleu de sortie pour robinet douchette	86	462886	19,00
	Válvula de un agua Single inlet valve Valve à une eau	550	462402	61,00
	Válvula de dos aguas Double inlet valve Valve à deux eaux	1.250	462404	66,00
	Juego válvulas antirretorno para grifo monomando dos aguas Anti-return valves set for double inlet one handle tap Conjoint de valvules anti-retour pour robinet monocommande à deux eaux	85	462846	18,00
	Tuerca de repuesto para caño giratorio 1/2" Spare nut for rotating tap 1/2" Écrou de rechange pour bec pivotant 1/2"	22	462818	5,30
	Adaptador para mástil Shower support adaptor Adaptateur pour support de douche	55	462832	6,00
	Piña para grifo monomando ducha extensible Shower head for one handle extending shower tap Pomme pour robinet monocommande douche extensible	190	463250	51,00
	Latiguillo lastrado para grifo monomando ducha extensible Weighted hose for one handle extending shower tap Flexible lesté pour robinet monocommande douche extensible	437	463252	27,00
	Latiguillo de repuesto para grifo doméstico 463050 Spare hose for domestic tap 463050 Tuyau de rechange pour robinet domestique 463050	100	463083	24,00
	Kit de juntas para pulsador temporizado Gasket kit for push button timer Kit de joints pour bouton-poussoir temporisé	5	460450	6,00

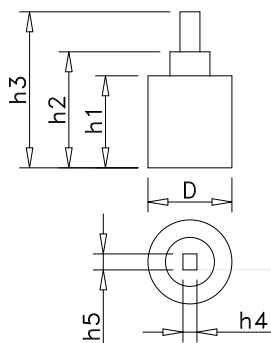

*Consultar para modelos descatalogados.

* For discontinued models contact us

* Consulter pour des modèles hors-catalogue

D	H1	H2	H3	H4	H5	Gr	Barcode	€
---	----	----	----	----	----	----	---------	---

Cartucho para válvula monomando
Spare cartridge for single lever valve
Cartouche pour valve monocommande

40 32 42 64 10 10,5 65 462830 **21,00**



463051	463064	463066	463072	463074
463038	463040	463228	463213	465206
463206	463236	463208*	463227	465208
462412	462408	464614	463602	463204*

D	H1	H2	H3	H4	H5	Gr	Barcode	€
---	----	----	----	----	----	----	---------	---

Cartucho para válvula monomando
Spare cartridge for valve
Cartouche de rechange pour valve

40 43 54 75 10 10,3 78 463082 **23,00**



463428	463234	463216*	462406*	463050	463062
463214	463228	463218*	463216		

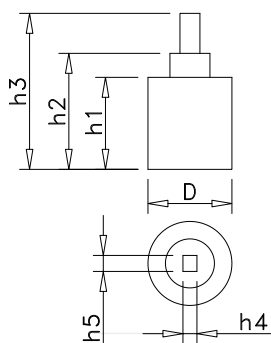

* Consultar para modelos descatalogados.

* For discontinued models contact us

* Consulter pour des modèles hors-catalogue

D H1 H2 H3 H4 H5 Gr €

Cartucho de repuesto para grifos

464632 y 464633

Spare cartridge for taps 464632 and 464633

464633

Cartouche de rechange pour robinets

464632 et 464633

39,50 43 51 75 10 10,5 55 464634 **29,00**



464632



464633

D H2 H3 H4 H5 Gr €

Cartucho para caño o válvula 1/4 de vuelta

Spare cartridge for spout or 1/4 turn valve

Cartouche pour bec ou valve 1/4 de tour

18,5 37 51,6 7,6 7,6 64 462864 **14,00**



463052



463062



463066



463060



463058



463070



463081



463046



463048



463430



463424



462803



463422

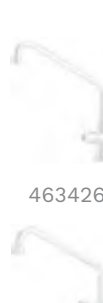

463426



463420

Gr €



Cartucho para válvula RD

Spare cartridge for RD valve

Cartouche de rechange pour valve RD

70 462888 **14,00**

Cartuchos para modelos descatalogados

Cartridges for discontinued models

Cartouches pour des modèles hors-catalogue

D H1 H2 H3 H4 H5   €



Cartucho para válvula
Spare cartridge for valve
Cartouche de rechange pour valve

42 46 58 78 7 8 90 462828 **49,00**



Adaptador para cartucho 462828 y leva 462842
Adapter for spare cartridge 462828 and handle 462842
Adaptateur de remplacement pour cartouche 462828 et levier 462842

120 462860 **23,50**



























Cartucho para válvula
Spare cartridge for valve
Cartouche de rechange pour valve

41 49 61 81 6,4 7 93 463258 **47,00**





		<p>Piña para ducha de gran alcance M 1/2" Shower head for long-reach shower M 1/2" Pomme pour douche à grande portée M 1/2"</p>	85	463020	27,00
		<p>Latiguillo para ducha de gran alcance 2000 mm H-H 1/2" Hose for long-reach shower F-F 1/2" Flexible pour douche a grande portée F-F 1/2"</p>	230	463022	14,00
		<p>Piña para ducha horno M 1/2" Shower head for oven shower M 1/2" Pomme pour douche de four M 1/2"</p>	250	463024	57,00
		<p>Latiguillo para ducha horno 2000 mm H-H 1/2" Hose for oven shower F-F 1/2" Flexible pour douche de four F-F 1/2"</p>	530	462810	27,00
		<p>Piña para ducha horno 463006 Shower head for shower oven 463006 Tête de douche pour four à douche 463006</p>	250	463026	90,00
		<p>Latiguillo para ducha horno enrollable 463006 y 463008 Roll hose for oven shower 463006 & 463008 Rouler pour douche de four 463006 et 463008 L=1.700 mm.</p>	280	463010	30,00
		<p>Juego de juntas para grifo manguera serie profesional 8 m. Joints set for professional faucet hose 8 m. Conjoint de joints pour robinet-tuyau d'arrosage modèle professionnel 8 m.</p>	30	464068	72,00
		<p>Manguera de repuesto 8 m para grifo de manguera serie profesional Hose complement 8 m. Tuyau d'arrosage de rechange 8 m.</p>	2.500	464064	113,00
		<p>Manguera de repuesto 15 m. para grifo manguera serie inox. Hose complement 15 m. Tuyau d'arrosage de rechange 15 m.</p>	3.000	464066	198,00
		<p>Manguera de repuesto 12 m. para grifo manguera serie profesional Hose complement 12 m. Tuyau d'arrosage de rechange 12 m.</p>	2.500	464074	108,00
		<p>Lanza rociadora M 1/2" Nozzle shower M 1/2" Lance M 1/2"</p>	165	464060	72,00
		<p>Pistola para lanza de acero inoxidable H 1/2" Pistol for stainless steel nozzle F1/2" Pistolet pour lance en acier inoxydable F1/2"</p>	450	464070	61,00



MOBILIARIO

NEUTRAL FURNITURE
MEUBLES NEUTRES

NOVEDADES

NEWS
NOUVEAUTÉS



294



297



298

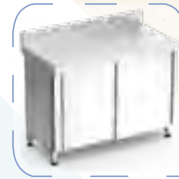

299



322



323



324



324



346



350









Detalle de cajón acoplado.
Fixed drawer coupled.
Détail de tiroir couplé.



Los modelos con este distintivo pueden fabricarse con altura de 600 mm para cocinas serie snack o modular, sin alterar el precio. Consultar plazo de entrega.
The models with this badge can be manufactured with height 600 mm. for snack or modular stoves without price increasing. Ask delivery time.
Les modèles avec cet insigne peuvent être fabriqués avec hauteur 600 mm pour snack ou modulaire cuisines sans augmentation de prix. Demandez délai de livraison.

Características de fabricación de nuestras mesas:

Totalmente fabricadas en acero inoxidable.
Encimera reforzada e insonorizada de 1,5 mm de espesor.
Bastidores inferiores de refuerzo bajo encimera en acero inoxidable.
Bastidor preparado para incorporar entrepaños sin la utilización de herramientas.
Patas de 40 x 40 mm desplazadas para curva sanitaria, acabado brillante.
En la fabricación de nuestras mesas no empleamos madera.
Se adaptan a cualquier desnivel del suelo ya que disponen de pies regulables.
Opcionalmente se pueden instalar los siguientes accesorios:



Sistema de elevación	298
Cajones y tolvas de café	492
Papelera lateral	394
Portacuchillos	136
Ruedas	496
Fibras de polietileno	75
Contenedores de desperdicios	385
Tolva de desbarasado	465
Fregaderos soldados	317
Esterilizadores de cuchillos	370

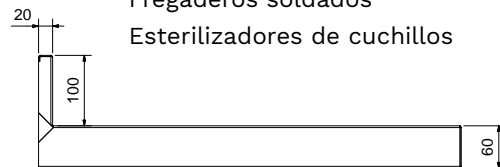

Manufacturing characteristics of our tables:

Fully made of stainless steel.
Reinforced and soundproofed worktop 1.5 mm thick.
Lower supporting structure under stainless steel worktop and ready to install shelves without the use of tools.
1.5 mm worktop reinforced and acoustically treated 40x40 mm set back tubular legs to avoid pipes.
Adjustable feet for a better stability, to have it fitted to any floor unevenness.
No wood is used in the manufacture of our tables
Optionally, the following accessories can be installed:



Lifting system	298
Drawers	492
Side wastepaper bin	394
Knifeholder	136
Wheels	496
Polyethylene fibres	75
Waste receptacle for scraps	385
Fixed sinks	465
Containers	317
Knifeholder disinfectant	370



Detalle de rueda de acero inoxidable con freno acoplada a pata.
Detail of stainless steel wheel with brake assembled to leg.
Détail de roue en acier inoxydable avec frein installé dans pied.

Detalle de pata con pie regulable con funda antivibradora.
Detail of adjustable feet with antivibrator cover.
Détail de pie réglable avec base anti-vibrateur.

Caractéristiques de fabrication de nos tableaux:

Fabriquée entièrement en acier inoxydable
Plan de travail renforcé et insonorisé de 1,5 mm d'épaisseur
Armatures inférieures de renfort sous le plan de travail d'acier inoxydable.
Armature préparée pour incorporer des étagères sans l'utilisation d'outils.
Plan renforcé et insonorisé de 1,5 mm d'épaisseur
Empiètements en tube de 40 x 40 déplacés pour courbure sanitaire
Empiètements réglables pour favoriser la stabilité, car ils s'adaptent à quelque dénivellement du sol.
Dans la fabrication de nos tables, nous n'employons pas de bois.
Optionnellement on peut installer les suivantes accessoires



Système d'élévation	298
Tiroirs et trémie pour marc de café	492
Corbeille à papier lateral	394
Porte couteaux	136
Roues	496
Fibras en polyéthylène	75
Trémie d'évacuation des déchets	385
Eviers soudés	465
Conteneurs	317
Porte-couteaux désinfecteur	370

Mesas centrales

Centre table
Tables centrales

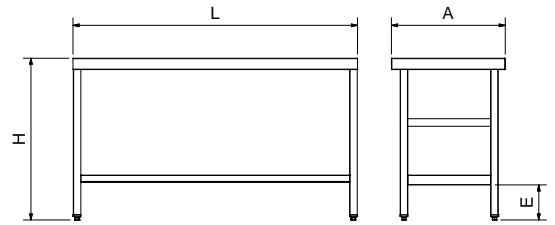

L	A	H	E	Kg	Barcode	€	Kg	Barcode	€	Kg	Barcode	€
1.000	500	850	200	27,0	070202	511,00	23,0	070402	481,00	5,0	2702028	116,00
1.200	500	850	200	26,0	070220	569,00	21,0	070420	535,00	4,0	2702608	125,00
1.500	500	850	200	36,0	070204	625,00	29,0	070404	588,00	9,0	2702048	134,00
2.000	500	850	200	47,0	070206	674,00	36,0	070406	633,00	13,0	2702068	151,00
1.000	600	850	200	29,0	070208	571,00	25,0	070408	537,00	6,0	2702088	134,00
1.200	600	850	200	30,7	070228	604,00	24,9	070428	568,00	6,0	2702688	142,00
1.500	600	850	200	38,0	070210	635,00	32,0	070410	597,00	10,0	2702108	151,00
2.000	600	850	200	52,0	070212	708,00	40,0	070412	665,00	15,0	2702128	169,00
1.000	700	850	200	33,0	070214	622,00	29,0	070414	584,00	8,0	2702148	151,00
1.200	700	850	200	34,8	070236	654,00	27,1	070436	614,00	5,6	2702768	160,00
1.500	700	850	200	43,0	070216	686,00	34,0	070416	645,00	13,0	2702168	169,00
2.000	700	850	200	60,0	070218	776,00	46,0	070418	730,00	19,0	2702188	186,00

Mesas murales

Wall tables
Tables murales

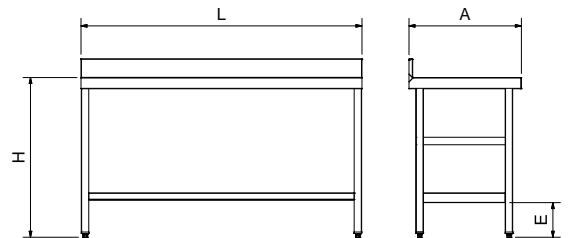

L	A	H	E	Kg	Barcode	€	Kg	Barcode	€	Kg	Barcode	€
1.000	500	850	200	24,0	070602	541,00	21,0	070802	498,00	5,0	2702028	116,00
1.200	500	850	200	26,7	070620	589,00	21,7	070820	554,00	4,0	2702608	125,00
1.500	500	850	200	35,0	070604	628,00	29,0	070804	610,00	9,0	2702048	134,00
2.000	500	850	200	47,0	070606	677,00	37,0	070806	656,00	13,0	2702068	151,00
1.000	600	850	200	27,0	070608	592,00	23,0	070808	557,00	6,0	2702088	134,00
1.200	600	850	200	31,3	070628	626,00	25,5	070828	588,00	4,8	2702688	142,00
1.500	600	850	200	38,0	070610	658,00	32,0	070810	619,00	10,0	2702108	151,00
2.000	600	850	200	52,0	070612	735,00	40,0	070812	691,00	15,0	2702128	169,00
1.000	700	850	200	31,0	070614	645,00	26,0	070814	606,00	8,0	2702148	151,00
1.200	700	850	200	35,4	070636	679,00	27,8	070836	637,00	5,6	2702768	160,00
1.500	700	850	200	45,0	070616	713,00	37,0	070816	670,00	13,0	2702168	169,00
2.000	700	850	200	61,0	070618	804,00	46,0	070818	757,00	19,0	2702188	186,00

Mesas murales con puertas

Wall tables with doors

Tables murales avec portes



Características:

Fabricada íntegramente en acero inoxidable, laterales y trasera cerrados en acero inoxidable. Entrepaña inferior a 200 mm del suelo y el otro centrado. La principal ventaja de nuestras mesas de puertas correderas consiste en que las puertas van colgadas, lo que evita depósitos de suciedad en carriles y entrepaños. Tiradores integrados en la puerta.

Characteristics:

Fully made of stainless steel, sides and back covered with stainless steel panels. Centered shelf.

The main advantage of our sliding doors tables consists on their hanging doors. They avoid dirtiness deposits in rails and shelves. Furthermore the handles are integrated in the door.

Caractéristiques:

Entièrement fabriquée en acier inoxydable, latérales et fond recouvertes en acier inoxydable. Tablette-rayon centré.

La principale avantage de nos tables à portes coulissantes c'est que ses portes sont suspendues pour éviter des dépôts de saleté dans les rails et dans les tablettes-rayons. En plus les poignées sont intégrées dans la porte.

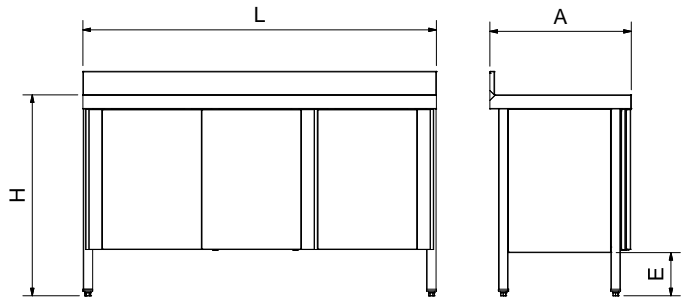
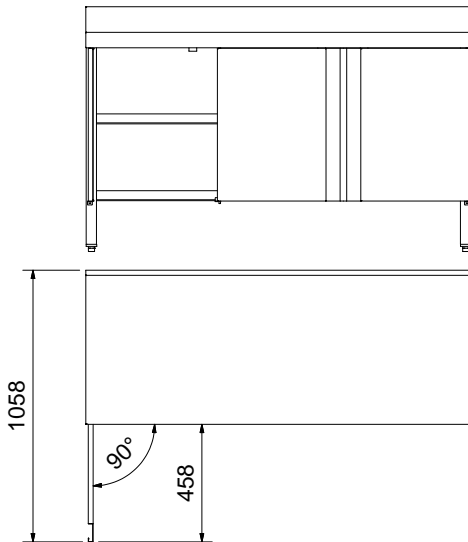

Correderas
Sliding doors
Coulissantes

Abatibles
Hinged doors
Deux battants

L	A	H	E	Kg	Barcode	Qty	€	Kg	Barcode	Qty	€
1.000	400	850	200	28,0	073803	2	1.035,00				
1.000	500	850	200	40,0	073802	2	1.006,00	42	074002	2	1.026,00
1.500	500	850	200	56,0	073804	3	1.245,00	59	074004	3	1.270,00
2.000	500	850	200	67,0	073806	4	1.468,00	71	074006	4	1.498,00
1.000	600	850	200	43,0	073808	2	1.197,00	45	074008	2	1.222,00
1.500	600	850	200	58,0	073810	3	1.417,00	61	074010	3	1.446,00
2.000	600	850	200	77,0	073812	4	1.637,00	81	074012	4	1.670,00
1.000	700	850	200	48,0	073814	2	1.292,00	50	074014	2	1.320,00
1.500	700	850	200	64,0	073816	3	1.522,00	67	074016	3	1.554,00
2.000	700	850	200	84,0	073818	4	1.749,00	88	074018	4	1.784,00

Mesas murales a pared

Wall-fitted tables

Tables à fixer au mur



L	A	H	Kg	Barcode	€
1.000	500	450	17	071002	570,00
1.500	500	450	22	071004	696,00
1.000	600	450	23	071006	604,00
1.500	600	450	28	071008	751,00
1.000	700	450	26	071010	679,00
1.500	700	450	34	071012	823,00

Mesas murales con puertas y cajones

Wall tables with with doors and drawers
Tables murales avec portes et tiroirs



Characteristics:

Fully manufactured in stainless steel (both internal and external).
Reinforced and soundproofed worktop in 1.5 mm. thickness
Two or three suspended sliding doors, without bottom rails to avoid deposits of dirt.
Side panels.
Double shelf. Closet area with rear and interior sides paneled.
Four drawers with lock. Interior dimensions of the drawers: 460x440x140 mm.
Retracted hind legs to adapt to the sanitary curves of the floor with wall.
Adjustable feet to meet the food standards.

Caractéristiques:

Entièrement fabriquée (intérieurement et extérieurement) en acier inoxydable.
Plan de travail de 1,5 mm d'épaisseur, renforcé et insonorisé.
Deux ou trois portes coulissantes suspendues, sans rails inférieurs où la saleté peut être déposée.
Côtés doublés.
Double étagère, côté arrière et intérieur dans la zone de l'armoire.
Quatre tiroirs avec serrure. Dimensions intérieures des tiroirs: 460x440x140 mm.
Pattes arrière rétractées pour s'adapter aux courbes sanitaires du sol avec mur.
Pieds réglables norme alimentaire.

Características:

Fabricada totalmente (interior y exterior) en acero inoxidable.
Encimera de 1,5 mm de espesor, reforzada e insonorizada.
Dos o tres puertas de corredera suspendidas, sin carriles inferiores donde se pueda depositar la suciedad.
Laterales forrados.
Doble entrepaño, trasera y lateral interior en la zona del armario.
Cuatro cajones con cerradura. Dimensiones interiores de los cajones: 460x440x140 mm
Patatas traseras retranqueadas para adaptarse a las curvas sanitarias del suelo con pared.
Pies regulables norma alimentaria.

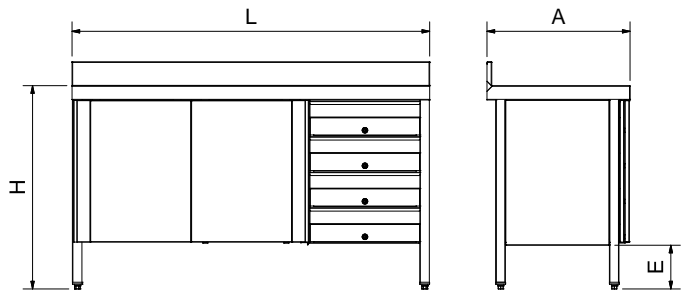

L	A	H	E		Kg		€
1.500	500	850	180	2	71	074474	2.020,00
1.500	600	850	180	2	73	074452	2.078,00
1.500	700	850	180	2	79	074456	2.504,00
2.000	500	850	180	3	82	074476	2.234,00
2.000	600	850	180	3	92	074454	2.361,00
2.000	700	850	180	3	99	074458	2.761,00

Mesa mural con cartelas

Wall fitted table with brackets
Table murale avec équerres

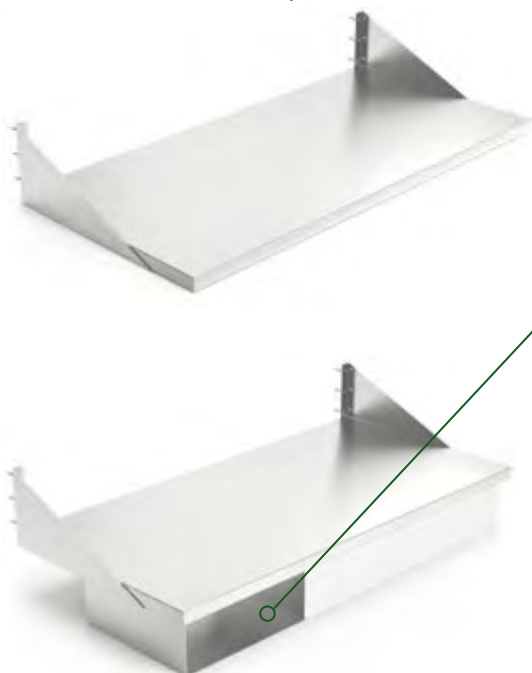

085426 € Op 68,00

Cajonera para mesa mural con cartelas (400 mm.)
Drawer box for wall-fitted table with brackets
Tiroirs pour table murale avec équerres

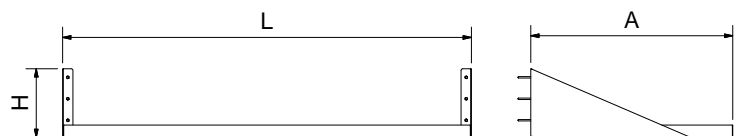

L	A	H	Kg		€
800	600	200	6	071050	138,00
1.000	600	200	7	071052	141,00
1.200	600	200	8	071054	151,00
1.400	600	200	9	071056	154,00

Mesas murales de Chef

Chef wall table
Table murale de chef

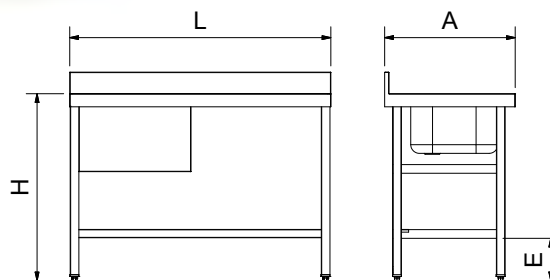
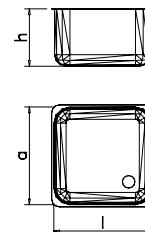

Válido para lavaplatos.
Valid for dish washers.
Valide pour machines à
laver assiettes.

	Con entreaño With shelf Avec tablette-rayon								Sin entreaño Without shelf Sans tablette-rayon					
	L	A	H	E	I	a	h	Kg	€		Kg	€		
	1.200	600	850	200	500	400	250	27	075202	785,00		24	075402	690,00
	1.200	700	850	200	500	500	300	29	075206	820,00		26	075406	725,00
	1.200	600	850	200	500	400	250	27	075204	785,00		24	075404	690,00
	1.200	700	850	200	500	500	300	29	075208	820,00		26	075408	725,00

Mesa mural desbarasado con fregadero

Wall table for waste chutes with sink
Table murale vide déchets avec bac

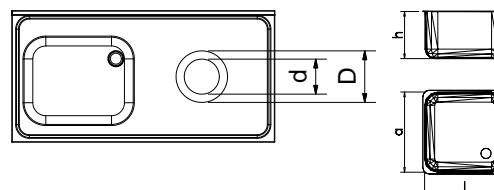
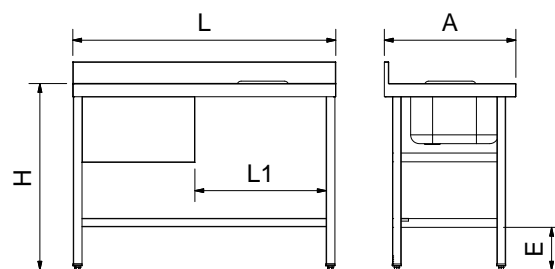

	L	A	H	E	I	a	h	L1	D	d	Kg	€	
	1.200	600	850	195	500	400	250	600	235	160	24,5	980300102	769,00
	1.200	700	850	195	500	500	300	600	235	160	26,5	980300104	804,00
	1.200	600	850	195	500	400	250	600	235	160	24,5	980300202	769,00
	1.200	700	850	195	500	500	300	600	235	160	26,5	980300204	804,00

Mesa mural desbarasado con puerta

Waste chutes wall table

Table murale pour trémie à déchets



Características:

Laterales forrados en acero inoxidable.
Aro para tolva de desbarasado color azul.
Tapa para aro.

Characteristics:

Sides covered with stainless steel panels.
Blue ring for waste chutes.
Ring lid.

Caractéristiques:

Latérales recouvertes en acier inoxydable.
Cercle bleu pour trémies à déchets.
Couvercle.

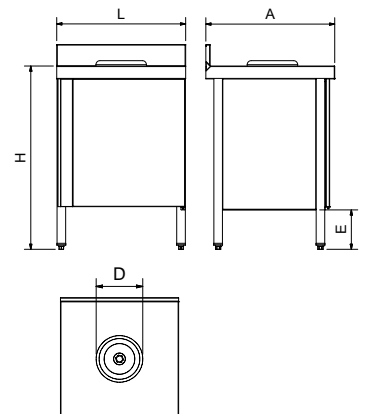

Ejemplo de zona de lavado. Posibilidad de diferentes combinaciones al poder colocar la mesa a uno u otro lado.
Example of rinse zone. Possibility of different combinations with the table on one side or the other.
Exemple de zone de lavage. Possibilité de diverses combinaisons avec la table d'un côté ou de l'autre.

L	A	H	D	E	Kg	Barcode	€
600	600	850	235	200	23	074438	601,00
600	700	850	235	200	28	074437	800,00

Mesa de preparación de verduras

Vegetable preparation table

Table de préparation de légumes

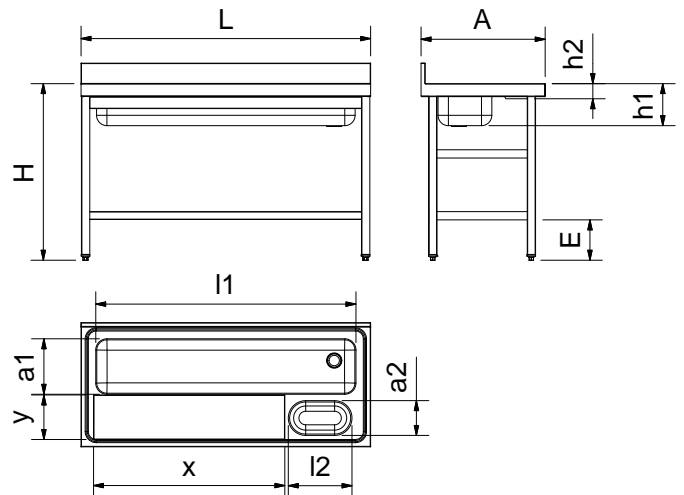

L	A	H	E	I1	a1	h1	I2	a2	h2	X	y	Kg	Barcode	€
1.400	600	850	200	1.250	260	180	300	160	50	925	215	28	075602	950,00

Mesas de preparación y lavado
Preparation and cleansing tables
Tables de préparation et de lavage



Dotación y características de fabricación:
Totalmente construida con acero inoxidable.
Fibra de polietileno calidad P-500.
Fregadero soldado con válvula, tapón y rebosadero.
Tolva de evacuación de desperdicios.

Features and manufacturing characteristics:
Fully made of stainless steel.
P-500 quality polyethylene cutting board.
Welded bowl with valve, plug and overflow.
Hole for waste-chutes



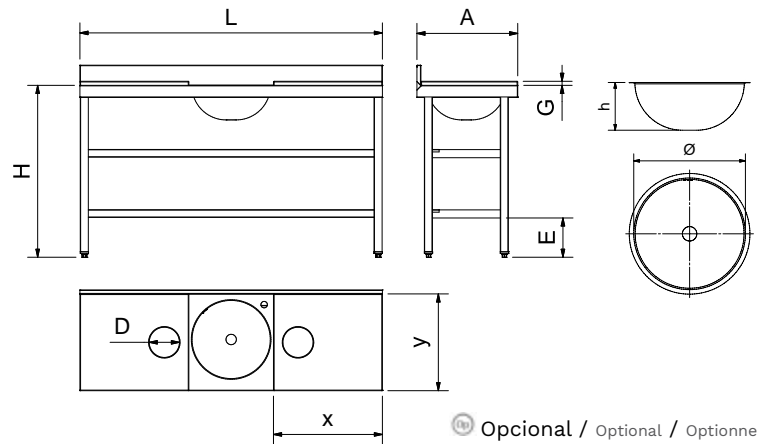

Dotation et caractéristiques de fabrication:
Entièrement fabriquées en acier inoxydable.
Plaque découpe de polyéthylène qualité P-500.
Bac soudée avec valve, déversoir.
Trou pour tremie à déchets.

 **Repuestos de fibras.**
Spare cutting boards.
Plaques de découpe.

 78



 Opcional / Optional / Optionnel

	L	A	H	E	Ø	h	X	y	G	D	Kg	€
	1.000	500	850	200	390	170	540	480	20	150	23,5	839,00
												072852
	1.000	500	850	200	390	170	540	480	20	150	23,5	839,00
												072860
	1.500	500	850	200	390	170	540	480	20	150	30,0	1.036,00
												072862
	1.500	500	850	200	390	170	540	480	20	150	30,0	1.036,00
												072870
	1.500	500	850	200	390	170	540	480	20	150	34,0	1.176,00
												072872

Mesa mural de prelavado
Pre-rinse wall table
Table mural de pré-lavage



Dotación y características de fabricación:
Totalmente construida en acero inoxidable, provista de reborde perimetral salva-aguas. Esta mesa está diseñada para albergar un lavavajillas y un contenedor de residuos debajo. Además hay espacio útil para depositar las cestas en la encimera antes del desbarasado.
Dotada de fregadero soldado con válvula, tapón, rebosadero y tolva de evacuación de desperdicios.
Incorpora tacos regulables en altura.

Equipment and manufacturing characteristics:

Fully made of stainless steel. Constructed with perimeter raised edge to avoid spilling water. Designed to lodge a dishwasher and a waste bin underneath. Additionally, there is room enough to place the baskets on the worktop before scrapping the wastes.

Équipement et caractéristiques de fabrication:

Dessus construit en acier inoxydable. Fabriquée avec rebord dans le périmètre pour éviter des reversement d'eau. Cette table a été dessinée pour allouer un lave-vaisselles et un conteneur de déchets dessous. En plus, il y a espace libre pour déposer des paniers dans le dessus avant l'évacuation des déchets.
Pourvu avec plonge soudé avec valve, bouchon et déversoir et trémie d'évacuation de déchets. Il inclut des vérins réglables en hauteur.

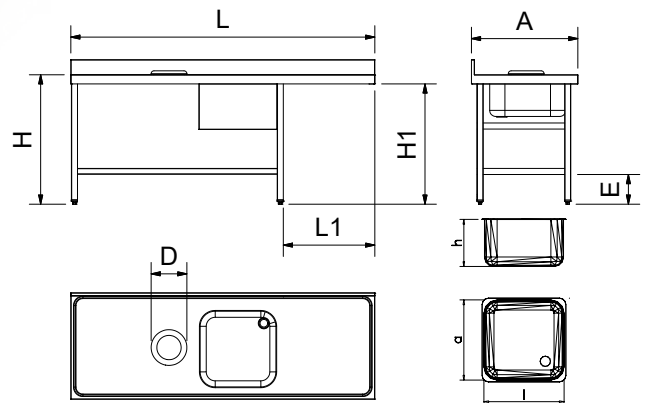

L	A	H	I	a	h	L1	H1	D	E	Kg	Barcode	€
---	---	---	---	---	---	----	----	---	---	----	---------	---

	2.000	700	930	500	500	300	605	870	235	200	40	074435	1.244,00
	2.000	700	930	500	500	300	605	870	235	200	40	074436	1.244,00

Incluido / Included / Inclus
 Opcional / Optional / Optionnel

Mesas de entrada / salida de lavavajillas

Inlet / outlet tables for dishwasher

Tables d'entrée/sortie pour lave-vaisselle



Fabricadas en acero inoxidable, estas mesas de entrada y salida para lavavajillas son regulables en altura y aptas para su ubicación tanto a izquierda como a derecha del lavavajillas.

Las cestas de lavavajillas de 500x500 mm encajan a la perfección en la parte superior del fregadero, facilitando la tarea del pre-lavado.

Incorporan entrepaño inferior de gran utilidad para el almacenaje de cestas vacías o llenas, despejando así la parte superior.

Combine esta mesa de entrada para lavavajillas con cualquiera de nuestros grifos ducha para obtener un máximo rendimiento.

Made of stainless steel, these inlet/outlet tables for dishwashers are height adjustable, and suitable both for the left or right hand of the dishwasher.

The 500x500 mm dishwasher racks fit seamlessly on the upper side of the sink for an easy pre-rinse operation

It is provided with a lower shelf, very helpful for the full or empty racks storage, to get a clear surface on the upper side.

Combine this inlet table for dishwashers with any of our shower taps to obtain the best performance.

Fabriquées en acier inoxydable, ces tables d'entrée et de sortie pour lave-vaisselle sont réglables en hauteur et peuvent être placées aussi bien à gauche qu'à droite du lave-vaisselle.

Les paniers lave-vaisselle de 500x500 mm s'adaptent parfaitement au dessus de l'évier, ce qui facilite le pré-lavage.

Ils intègrent une étagère inférieure très utile pour ranger les paniers vides ou pleins, dégageant ainsi la partie supérieure.

Combinez cette table d'entrée allant au lave-vaisselle avec n'importe lequel de nos robinets de douche pour une performance maximale.

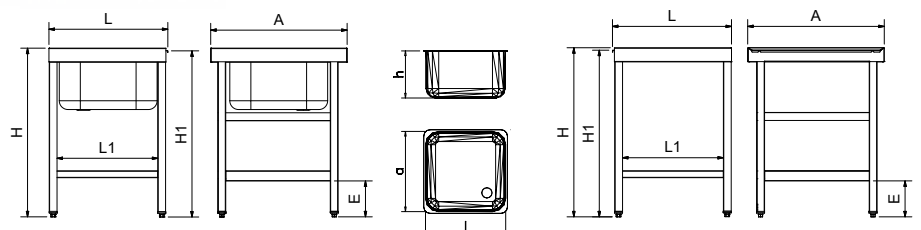

	L	A	H	L1	H1	E	I	a	h	Kg	Barcode	€
Light Grey	610	700	865	515	855	200	500	500	300	23,00	077202	756,00
Dark Grey	610	700	865	515	855	200				19,90	077250	426,00

Mesas murales de cajones

Wall-side tables with drawers
Tables murales à tiroirs



Características:

Provistas de cajones con rodamientos totalmente contruidos en acero inoxidable. Laterales forrados en zona de cajones. Cajones a mano derecha o izquierda a elección del cliente.

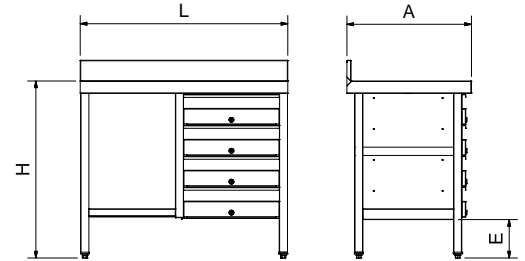

Characteristics:
Supplied with drawers, with all bearings made of stainless steel. Both sides panelled in the drawers zone. Drawers either on the right or on the left, at the customer's choice.

Caractéristiques:
Munies de tiroirs avec roulements entièrement fabriqués en acier inoxydable. Côtés recouverts au niveau des tiroirs. Tiroirs à droite ou à gauche au choix du client.

L	A	H	E	Kg	Barcode	€
1.000	500	850	200	44	074202	1.429,00
1.000	600	850	200	48	074204	1.477,00
1.000	700	850	200	54	074206	1.535,00

Mesa-bastidor para horno

Oven table-support
Table pour four

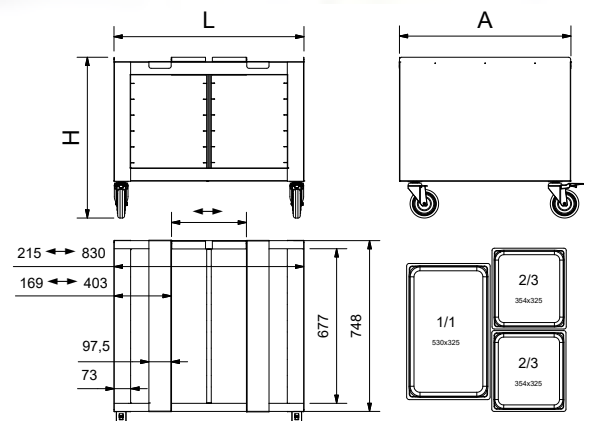

L	A	H	Kg	Barcode	€
832	750	700	30,70	074804	941,00

Mesas plegables con entrepaño

Centre table with shelf
Table centrale avec rayon

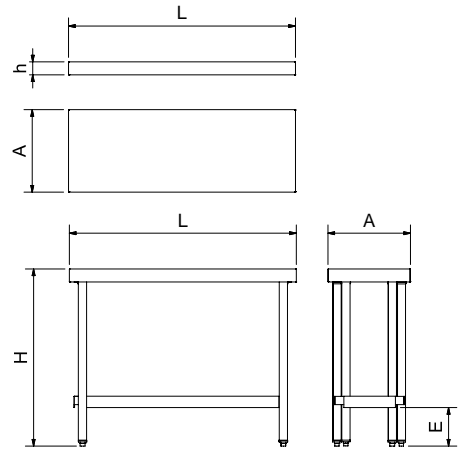

L	A	H	E	h	Kg	Barcode	€
1.100	400	860	187	63	16,0	075804	485,00
1.300	400	860	187	63	18,0	075806	505,00
1.100	500	860	187	63	17,0	075808	517,00
1.300	500	860	187	63	19,0	075810	538,00

Mesa mural satabanco con dos entrepaños

Console table with two shelves
Table console avec deux tablettes-rayons

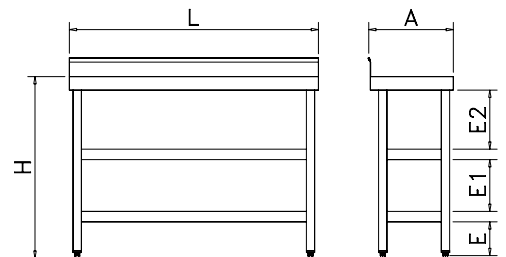

L	A	H	E	E1	E2	Kg	Barcode	€
1.000	400	850	200	243	243	15,95	074408	452,00
1.200	400	850	200	243	243	19,95	074410	477,00

Mesa central con dos entrepaños. Especial cortadoras de fiambre

Centre table with two shelves. Specially for cutting machines
Table centrale avec deux rayons. Special pour machines à couper

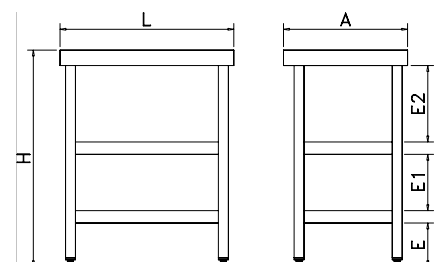

L	A	H	E	E1	E2	Kg	Barcode	€
705	505	855	150	270	270	18	074402	426,00

Mesa central con dos entrepaños. Especial cortadoras de fiambre

Centre table with two shelves. Specially for cutting machines

Table centrale avec deux rayons. Spécial pour machines à couper

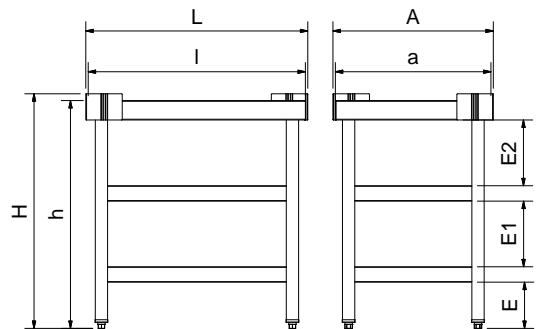

L	l	A	a	H	h	E	E1	E2	Kg	Barcode	€
720	705	520	505	762	740	150	213	213	13,80	074426	456,00

Mesa central con ruedas y 2 entrepaños

Centre table with wheels and 2 shelves

Table centrale avec roulettes et 2 tablettes dessous

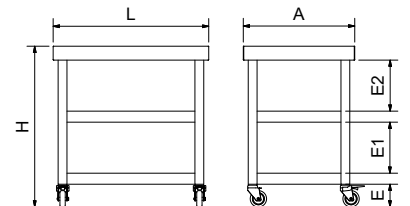

L	A	H	E	E1	E2	Kg	Barcode	€
705	505	730	100	230	230	23,00	074418	519,00

Soporte sobre-mostrador para cortadoras de fiambre

Stand support for cutting machine

Support sur comptoir pour coupe-charcuterie



Características:

Altura regulable.
Las guías inferiores son regulables para la adaptación al ancho de la tapa del evaporador de cualquier vitrina.

Characteristics:

Adjustable height.
The lower rails are adjustable to adapt the width of the evaporator cover of any display.

Caractéristiques:

Hauteur réglable.
Les rails inférieurs sont réglables pour l'adaptation du largeur du couvercle de l'évaporateur à quelque comptoir.

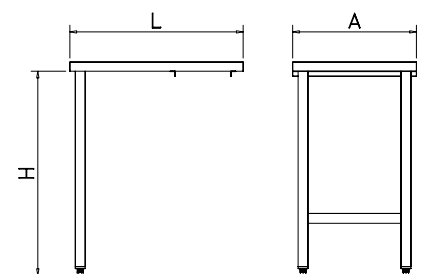

L	A	H	Kg	Barcode	€
690	490	802-882	8,15	082204	272,00

Mesa central con entrepaño. Especial maquinaria

Centre table with shelf. Specially for machines
Table centrale avec rayon. Spécial pour machinerie

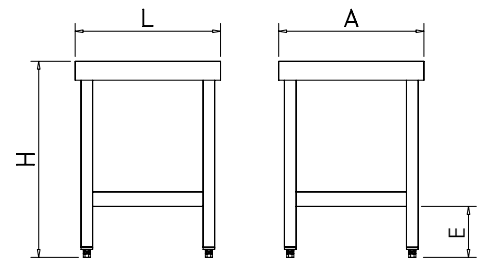

L	A	H	E	Kg	Barcode	€
505	505	655	150	15	074422	304,00

Mesa central con entrepaño especial maquinaria - Altura estándar

Center table with shelf, special for machinery - Standard height
Table centrale spéciale machine , avec étagère dessous- Hauteur standard

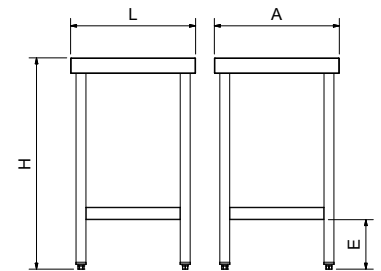

L	A	H	E	Kg	Barcode	€
505	505	853	200	8,15	074420	319,00

Mesa para maquinaria con sistema de elevación

Table for machinery with lifting system
Table spéciale machines avec système d'élévation



Características:

Con esta utilidad, su personal, independientemente de su altura, podrá adaptar el centro de trabajo a las necesidades particulares, realizando su jornada diaria mucho más cómoda y segura, evitará malas posturas y en gran medida, posibles accidentes o lesiones.

Characteristics:

With this utility, your staff, regardless of their height, can adapt the workplace to particular needs, making their daily work much more comfortable and safer, avoid bad postures and to a large extent, possible accidents or injuries.

Caractéristiques:

Avec cet exemplaire, votre personnel, quelle que soit sa taille, peut adapter le lieu de travail à ces besoins particuliers, réalisant son travail quotidien de forme plus confortable et sûre, évitant les mauvaises positions et en outre mesure les possibles accidents ou blessures.

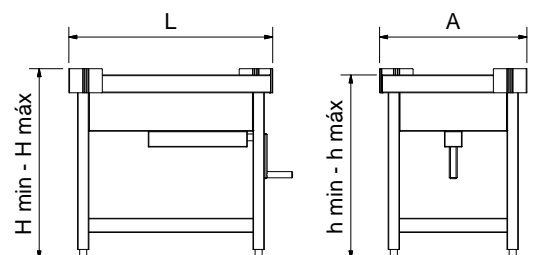

L	A	H min	H max	h min	h max	Kg	Barcode	€
721	521	672	872	650	850	20,00	074470	1.521,00

Mesa mural inox con sistema de elevación

Stainless steel wall table with lifting system
Table inox adossée avec système de levation



Características:

Con esta utilidad, su personal, independientemente de su altura, podrá adaptar el centro de trabajo a las necesidades particulares, realizando su jornada diaria mucho más cómoda y segura, evitará malas posturas y en gran medida, posibles accidentes o lesiones.

Characteristics:

With this utility, your staff, regardless of their height, can adapt the workplace to particular needs, making their daily work much more comfortable and safer, avoid bad postures and to a large extent, possible accidents or injuries.

Caractéristiques:

Avec cet exemplaire, votre personnel, quelle que soit sa taille, peut adapter le lieu de travail à ces besoins particuliers, réalisant son travail quotidien de forme plus confortable et sûre, évitant les mauvaises positions et en outre mesure les possibles accidents ou blessures.

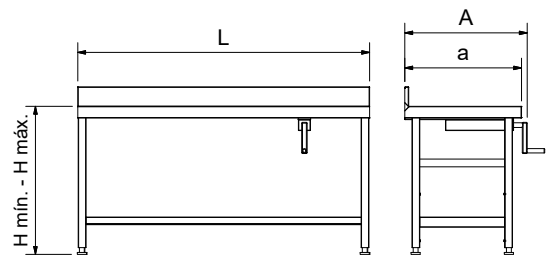

L	A	a	H _{min}	H _{max}	Kg	Barcode	€
1500	630	600	760	960	40,00	070662	1.673,00

Mesa mural con puertas y sistema de elevación eléctrico

Wall-side table with doors and electric lifting system
Table murale avec portes et système de levage électrique

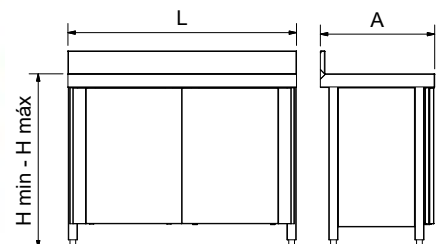

L	A	H _{min}	H _{max}	Kg	Barcode	€
1000	500	760	960	50,00	073860	2.150,00

Mesa de terraza

Terrace working table
Table Terrasse



Diseñada para su uso en terrazas y exteriores, esta mesa será de gran utilidad.
Fabricada en acero inoxidable AISI 304, incorpora dos cajones sencillos y uno doble, todos ellos con cerradura.
Cuenta con una puerta abatible.
Dispone de cuatro ruedas giratorias de estructura galvanizada y banda de rodadura de goma anti-sonora, dos de ellas con freno.

Opcionalmente se le pueden instalar:
Estanterías de sobremesa.
Portanotas mural.
Adaptador de cestillos cuberteros.
Adaptador de contenedor desperdicios.
Adaptador de cubetas gastronorm.
Kit de utensilios, válido también para manteles de papel.
Tolva para evacuación de desperdicios en el lateral de la zona de la puerta.

081802 25,00 462

Porta-notas mural
Wall mounted note-holder
Porte-notes mural

486024 24,00 389

Contenedor de desperdicios y reciclaje
Waste and recycling container
Conteneur à ordures et recyclage

076060 316,00 313
276060

Estanterías de sobremesa
Desktop shelves
Étagères à poser sur table

020102 37,00 49

Kit para colgar utensilios
Tool-holder kit
Kit pour suspendre outils



Specially designed for outdoor and terrace use. This table will be very useful.

Made of stainless steel AISI 304. It is provided with two single drawers and a double one, all of them with lock.

Cabinet with hinged door.

It has four rotating wheels, two of them with brake, with structure in galvanized steel and anti-noise rolling profile in rubber.

Optionally, the following accessories can be installed:

Tabletop shelves.

Wall-mounted tab grabber.

Adaptor for cutlery basket.

Adaptor for waste container.

Adaptor for Gastronorm container.

Tool-holder kit, also suitable for disposable tablecloths.

Waste receptacle for scraps, on the side of the cabinet.

Conçue pour un usage en terrasse et en extérieur, cette table vous sera d'une grande utilité.

Fabriquée en acier inoxydable AISI 304, avec deux tiroirs simples et un double, tous avec serrure.

Disposée d'une porte rabattable.

Disposée de quatre roulettes tournantes de structure galvanisée et bande de roulement anti-sonore, deux d'elles avec frein.

Optionnellement on peut lui installer:

Des étagères à poser.

Porte-notes mural.

Adaptateur de panier à couverts.

Adaptateur de container de déchets.

Adaptateur de bac gastronorm.

Kit d'ustensiles, valide aussi pour des nappes en papier.

Tremie d'évacuation des déchets sur le côté dans la zone de la porte.

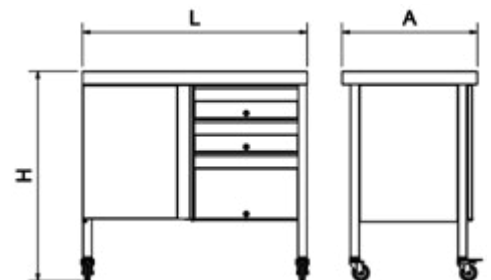

L	A	H	E	Kg	Barcode	€
1.000	600	930	270	55,0	075240	1.514,00

Mesa barman

Barman table
Barman tableau



Dotación de serie:

- 4 Cubetas GN 1/9 de 100 mm
- 3 Cubetas GN 1/2 de 200 mm
- 1 Fibra negra de 300x200x20 mm
- 1 Agujero evacuación de desperdicios.
- 1 Grifo monomando extensible cod. 463206
- 1 Cubeta fregadero Ø260x115 mm
- 1 Entrepaña.
- 4 Tacos regulables rosca sanitaria.

Equipment included:

- 4 Containers GN 1/9 100 mm
- 3 Containers GN 1/2 200 mm
- 1 Black cutting board 300x200x20 mm.
- 1 Waste chutes hole.
- 1 One handle elbow functioning tap, extending shower. Code 463206
- 1 Sink Ø 260x115 mm
- 1 Shelf
- 4 Plastic adjustable feet with thread inside.

Équipement inclus:

- 4 Bacs GN 1/9 100 mm
- 3 Bacs GN 1/2 200 mm
- 1 Plaque de découpe noire 300x200x20 mm.
- 1 Trou à déchets.
- 1 Robinet monocommande à coude, douche extensible.Cod 463206
- 1 Evier Ø 260x115 mm
- 1 Tablette-rayon.
- 4 Taquets réglables avec filet intérieur.



083060



70,00



462

Botellero
Wine rack
Porte-bouteilles

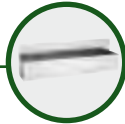

461430 15,00



201

Bidón de 10 lts
10 litres water drum
Bidon d'eau de 10 litres



486024 24,00



389

Contenedor de desperdicios
y reciclaje
Waste and recycling container
Conteneur à ordures et
recyclage



496

Ruedas
Wheels
Rouelles

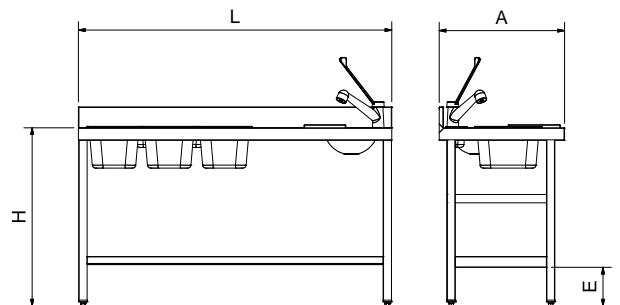
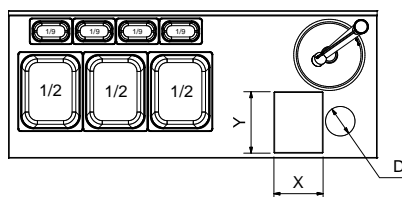
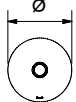
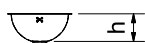

Incluido / Included / Inclus
 Opcional / Optional / Optionnel

L	A	H	E	D	X	Y	h	Ø	Kg		€
1.500	600	850	200	120	200	300	115	260	48,0	075250	1.200,00

Mueble cafetero inox basic

Stainless steel cabinet for coffee machine, basic line
Meuble pour cafetière en acier inoxydable simple



Mueble especial para cafeteras, fabricado completamente en acero inoxidable.

Incorpora un cajón preparado para los posos de café. En la parte inferior incluye un armario de puerta abatible, así como un módulo contiguo de 3 entrepaños para almacenaje. La encimera está provista de un agujero para realizar la instalación de la cafetera.



Specially for coffee machines. Made entirely of stainless steel.

Provided with a drawer for coffee grounds. In its lower part includes a hinged door and an adjoining set of 3 shelves. The worktop has a hole for the installation of the coffee machine.

Meuble spécial pour cafetière, fabriqué entièrement en acier inoxydable.

Il intègre un tiroir préparé pour le marc de café. Dans la partie inférieure intègre un meuble à portes pliantes, ainsi qu'un module contigu de 3 tablettes pour le stockage. Dotée d'un trou pour l'installation de la machine à café.

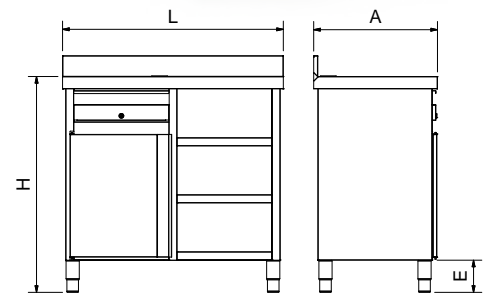
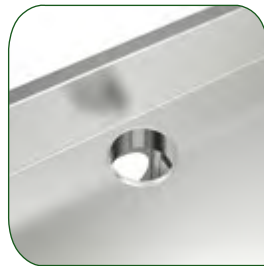

L	A	H	E	Kg	074602	€
1.070	600	1.040	150	48,42	074602	956,00

Mueble cafetero inox doble

Stainless steel cabinet for coffee machine, twin line
Meuble inox pour cafetière double



Mueble especial para cafeteras, fabricado completamente en acero inoxidable.

Incorpora un cajón preparado para los posos de café. En la parte inferior incluye un armario de puerta abatible. A cada lado del armario se incluyen módulos de 3 entrepaños para aumentar el espacio de almacenaje. La encimera está provista de un agujero para realizar la instalación de la cafetera.



Specially for coffee machines. Made entirely of stainless steel.

Provided with a drawer for coffee grounds. In its lower part includes a hinged door and one set of 3 shelves at every side, for an increased storage capacity. The worktop has a hole for the installation of the coffee machine.

Meuble spécial pour cafetière, fabriqué entièrement en acier inoxydable.

Dans le module central intègre un tiroir préparé pour le marc de café. Dans la partie inférieure inclus un armoire à porte battante. Sur chaque côté, inclus des modules de 3 tablettes pour augmenter l'espace de stockage. Dotée d'un trou pour l'installation de la machine à café.

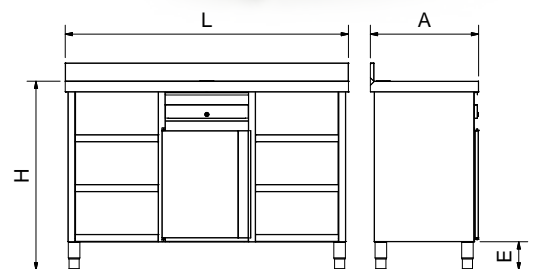
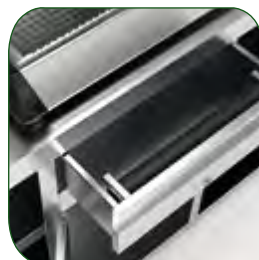

L	A	H	E	Kg	074620	€
1.570	600	1.040	150	70,58	074620	1.300,00

Isla de cocina inox con encimera de madera de pino

Kitchen island with pinewood worktop
Ile de cuisine inox avec plan de travail en bois de pin

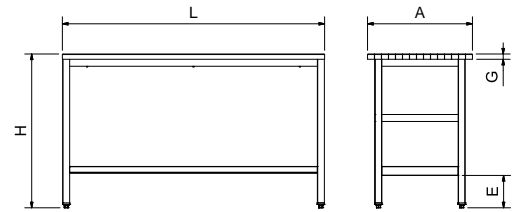

L	A	H	E	G	Kg	Barcode	€
1.000	600	880	200	30	33,0	076808	650,00
1.500	600	880	200	30	45,5	076810	804,00

Isla de cocina inox con encimera de granito

Kitchen island with granite worktop
Ile de cuisine inox avec plan de travail en granit

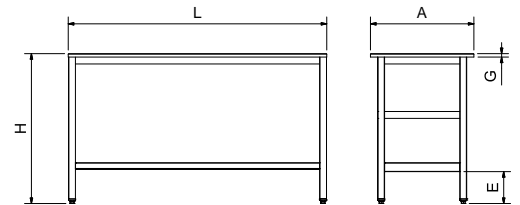

L	A	H	E	G	Kg	Barcode	€
1.000	600	870	200	20	49,0	076858	658,00
1.500	600	870	200	20	70,0	076860	806,00

Mesa central inox con encimera de cristal traslúcido

Inox center table with translucent glass worktop
Table centrale inox avec plan de travail en verre

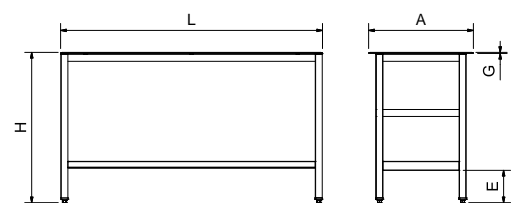

L	A	H	E	G	Kg	Barcode	€
1.000	600	860	200	6	25,9	076878	703,00
1.500	600	860	200	6	29,8	076880	875,00



Punto de venta portátil de jamones

Mobile sale point of hams

Point de vente de jambon portable



Características de fabricación:

- Ruedas de $\varnothing 75$ mm.
- 2 cajones pequeños
- 1 cajón grande
- 2 puertas abatibles
- 1 contenedor verde 486026
- 1 Portacuchillos con envoltente
- 1 Dispensador de 1 caja de guantes
- 1 Dispensador de papel y bolsas triple
- 1 Kit portarrollos
- 1 Pletina de 1500 mm. con 12 ganchos para jamones
- 1 base de jamonero giratorio basculante RT-3D
- 3 jamoneros giratorios RT-2D
- 1 fibra negra de 500x465x20 mm. con agujero de desbarasado
- Espacio disponible para báscula

Manufacturing characteristics:

- Wheels $\varnothing 75$ mm.
- 2 small drawers
- 1 large drawer
- 2 folding doors
- 1 green container 486026
- 1 Knife holder with casing
- 1 Dispenser for 1 glove box
- 1 Triple dispenser for paper and bags
- 1 Roll holder kit
- 1 1500 mm bar with 12 hooks for hams
- 1 foot of tilting rotating ham holder RT-3D
- 3 rotary ham holders RT-2D
- 1 black board of 500x465x20 mm with hole for disposals
- Enough room for a scale

Caractéristiques de fabrication:

- Roues $\varnothing 75$ mm.
- 2 petits tiroirs
- 1 grand tiroir
- 2 portes ouvrantes
- 1 container vert 486026
- 1 Porte-couteau avec enveloppant
- 1 Distributeur de 1 boîte à gants
- 1 Distributeur triple papier et sac
- 1 Kit de support de rouleau
- 1 Plaque de 1500 mm. avec 12 crochets pour les jambons
- 1 base de porte-jambon rotatif basculant RT-3D
- 3 porte-jambons rotatifs RT-2D
- 1 plaque noire de 500x465x20 mm. avec trou pour déchets
- Espace disponible pour la balance.

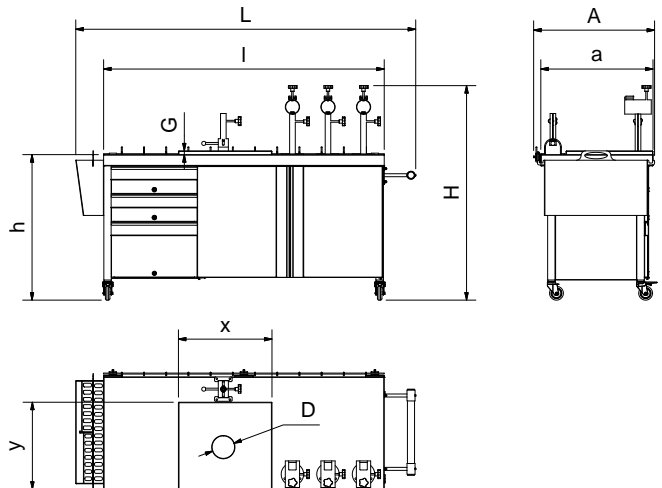

L	I	A	a	H	h	X	Y	G	D	Kg	Barcode	€
1.815	1.500	645	600	1150	780	500	465	20	120	98,00	075230	3.310,00

Estante abatible de fibra para punto de venta portátil de jamones

Polyethylene hinged shelf for mobile sale point of hams

Étagère ouvrante en fibre pour point de vente de jambon portable

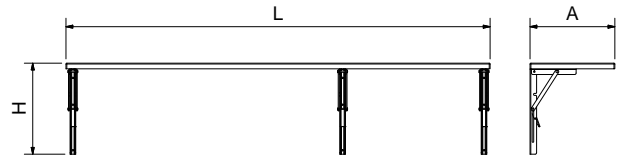

L	A	H	Kg	Barcode	€
1.500	300	325	10,3	075232	306,00

Mesa jamonera RT-2D

Ham table RT-2D

Table porte-jambon RT-2D

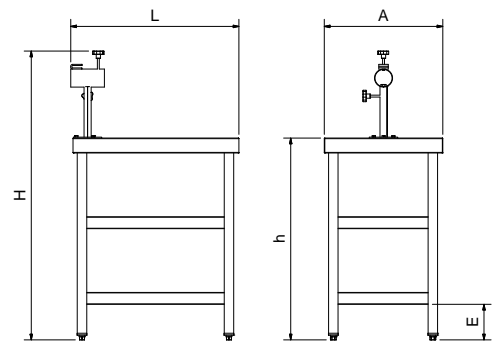

L	A	H	h	E	Kg	Barcode	€
710	500	1.220	850	150	20,00	074486	615,00

Mesa jamonera RT-3D

Ham table RT-3D

Table porte-jambon RT-3D

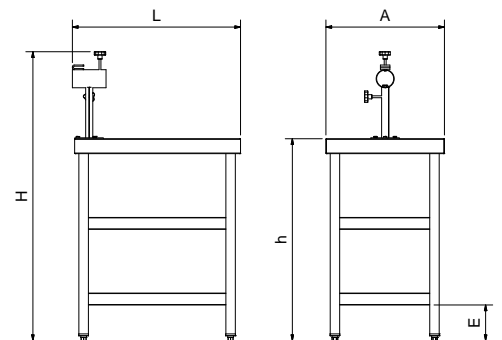

L	A	H	h	E	Kg	Barcode	€
710	500	1.220	850	150	20,00	074487	695,00

Mesas centrales encimera de polietileno

Centre tables with polyethylene worktop
Tables centrales dessus en polyéthylène



Es posible suministrarlas con fibra de diferente color. (Consultar)

There is the possibility of supplying them with other colours of fibre. (Ask for it)
Possibilité d'en fournir avec autres couleurs de fibre. (Demandez)

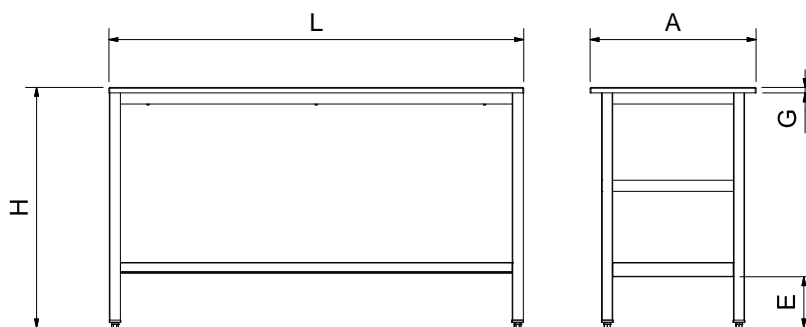

L	A	H	G	E	Kg	Barcode	€	Kg	Barcode	€	Kg	Barcode	€
1.000	500	870	20	200	22	071202	418,00	19	071402	382,00	5	2702028	116,00
						071252			071452				
1.500	500	870	20	200	34	071204	603,00	28	071404	549,00	9	2702048	134,00
						071254			071454				
2.000	500	870	20	200	46	071206	725,00	35	071406	660,00	14	2702068	151,00
						071256			071456				
1.000	600	870	20	200	25	071208	517,00	21	071408	470,00	6	2702088	134,00
						071258			071458				
1.500	600	870	20	200	37	071210	615,00	30	071410	558,00	10	2702108	151,00
						071260			071460				
2.000	600	870	20	200	53	071212	765,00	41	071412	697,00	15	2702128	169,00
						071262			071462				
1.000	700	870	20	200	28	071214	519,00	22	071414	472,00	8	2702148	151,00
						071264			071464				
1.500	700	870	20	200	42	071216	714,00	33	071416	648,00	13	2702168	169,00
						071266			071466				
2.000	700	870	20	200	57	071218	875,00	44	071418	797,00	19	2702188	186,00
						071268			071468				



Repuestos de fibras.
Spare cutting boards.
Plaques de découpe.

78

Mesas de preparación centrales

Centre preparation tables
Tables de préparation centrales



Es posible suministrarlas con fibra de diferente color. (Consultar)

There is the possibility of supplying them with other colours of fibre. (Ask for it)

Possibilité d'en fournir avec autres couleurs de fibre. (Demandez)

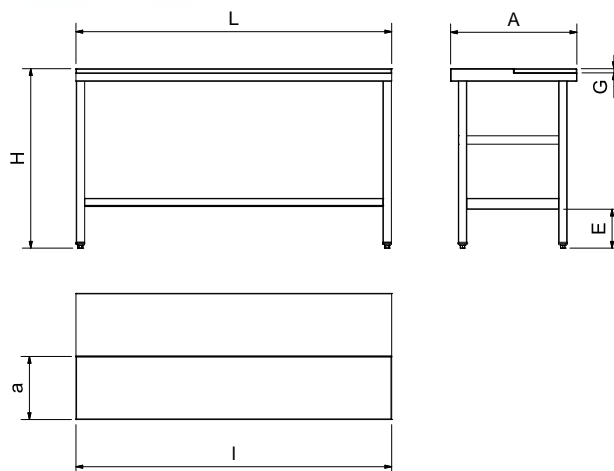

L	A	H	I	a	G	E	Kg	Barcode	€	Kg	Barcode	€	Kg	Barcode	€
1.000	600	850	1.000	300	20	200	37	071602 071652	1.055,00	32	071802 071852	965,00	6	2702088	134,00
1.500	600	850	1.500	300	20	200	50	071604 071654	1.204,00	44	071804 071854	1.092,00	10	2702108	151,00
2.000	600	850	2.000	300	20	200	66	071606 071656	1.355,00	54	071806 071856	1.100,00	15	2702128	169,00
1.000	700	850	1.000	300	20	200	42	071608 071658	1.137,00	37	071808 071858	1.046,00	8	2702148	151,00
1.500	700	850	1.500	300	20	200	56	071610 071660	1.305,00	47	071810 071860	1.182,00	13	2702168	169,00
2.000	700	850	2.000	300	20	200	75	071612 071662	1.457,00	61	071812 071862	1.310,00	19	2702188	186,00
1.000	800	850	1.000	300	20	200	47	071614 071664	1.224,00	39	071814 071864	1.100,00	10	2702208	171,00
1.500	800	850	1.500	300	20	200	62	071616 071666	1.391,00	51	071816 071866	1.250,00	14	2702228	189,00
2.000	800	850	2.000	300	20	200	82	071618 071668	1.559,00	66	071818 071868	1.401,00	21	2702248	207,00



Repuestos de fibras.
Spare cutting boards.
Plaques de découpe.

78

Mesas de preparación murales

Wall preparation tables

Tables de préparation murales



Es posible suministrarlas con fibra de diferente color. (Consultar)

There is the possibility of supplying them with other colours of fibre. (Ask for it)

Possibilité d'en fournir avec autres couleurs de fibre. (Demandez)

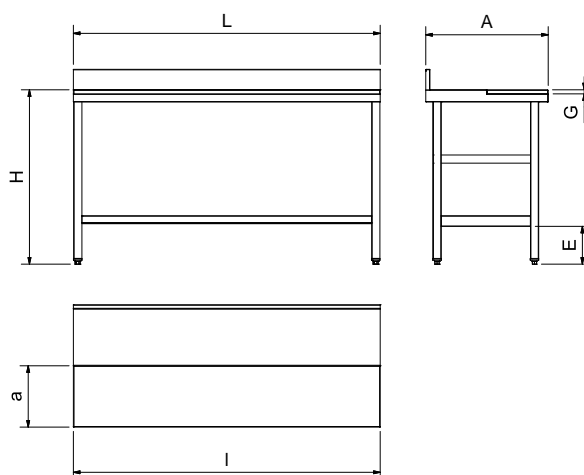

L	A	H	I	a	G	E	Kg	Barcode	€	Kg	Barcode	€	Kg	Barcode	€
1.000	600	850	1.000	300	20	200	37	072002 072052	1.042,00	33	072202 072252	959,00	6	2702088	134,00
1.500	600	850	1.500	300	20	200	49	072004 072054	1.185,00	42	072204 072254	1.084,00	10	2702108	151,00
2.000	600	850	2.000	300	20	200	64	072006 072056	1.330,00	52	072206 072256	1.220,00	15	2702128	169,00
1.000	700	850	1.000	300	20	200	39	072008 072058	1.121,00	34	072208 072258	1.040,00	8	2702148	151,00
1.500	700	850	1.500	300	20	200	54	072010 072060	1.287,00	46	072210 072260	1.164,00	12	2702168	169,00
2.000	700	850	2.000	300	20	200	73	072012 072062	1.433,00	59	072212 072262	1.298,00	18	2702188	186,00
1.000	800	850	1.000	300	20	200	44	072014 072064	1.199,00	36	072214 072264	1.097,00	10	2702208	171,00
1.500	800	850	1.500	300	20	200	60	072016 072066	1.365,00	50	072216 072266	1.242,00	14	2702228	189,00
2.000	800	850	2.000	300	20	200	78	072018 072068	1.545,00	62	072218 072268	1.399,00	21	2702248	207,00



Repuestos de fibras.
Spare cutting boards.
Plaques de découpe.

78

Mesas centrales con reborde y desagüe

Centre tables with raised edge and drain
Tables centrales avec rebord et trou d'écoulement

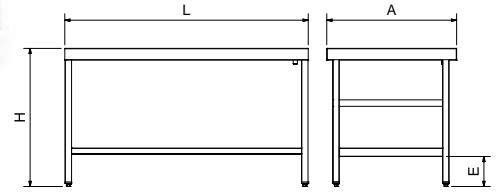

L	A	H	E	Kg	Barcode	€	Kg	Barcode	€	Kg	Barcode	€
1.000	600	850	200	46	073020	1.075,00	38	073220	958,00	11	2702088	134,00
1.500	600	850	200	54	073022	1.189,00	42	073222	1.058,00	15	2702108	151,00
2.000	600	850	200	76	073024	1.286,00	55	073224	1.121,00	25	2702128	169,00
1.000	700	850	200	49	073026	1.164,00	40	073226	1.026,00	12	2702148	151,00
1.500	700	850	200	58	073028	1.284,00	45	073228	1.133,00	16	2702168	169,00
2.000	700	850	200	81	073030	1.400,00	56	073230	1.222,00	26	2702188	186,00
1.000	800	850	200	38	073002	1.211,00	30	073202	1.068,00	10	2702208	171,00
1.500	800	850	200	51	073004	1.332,00	40	073204	1.167,00	14	2702228	189,00
2.000	800	850	200	67	073006	1.467,00	50	073206	1.277,00	21	2702248	207,00

Mesas murales con reborde y desagüe

Wall tables with raised edge and drain
Tables murales avec rebord et trou d'écoulement

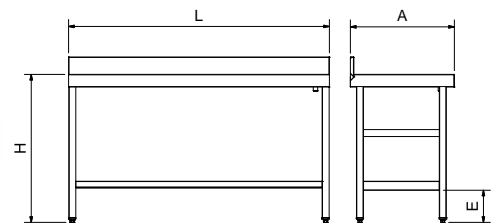

L	A	H	E	Kg	Barcode	€	Kg	Barcode	€	Kg	Barcode	€
1.000	600	850	200	30	073402	1.075,00	25	073602	958,00	6	2702088	134,00
1.500	600	850	200	39	073404	1.189,00	32	073604	1.058,00	10	2702108	151,00
2.000	600	850	200	51	073406	1.286,00	42	073606	1.121,00	15	2702128	169,00
1.000	700	850	200	33	073408	1.164,00	28	073608	1.026,00	8	2702148	151,00
1.500	700	850	200	46	073410	1.284,00	38	073610	1.133,00	12	2702168	169,00
2.000	700	850	200	60	073412	1.400,00	46	073612	1.222,00	18	2702188	186,00
1.000	800	850	200	36	073414	1.211,00	29	073614	1.068,00	10	2702208	171,00
1.500	800	850	200	49	073416	1.332,00	39	073616	1.167,00	14	2702228	189,00
2.000	800	850	200	65	073418	1.467,00	48	073618	1.277,00	21	2702248	207,00

Mesas de despiece

Quartering tables
Tables de découpage

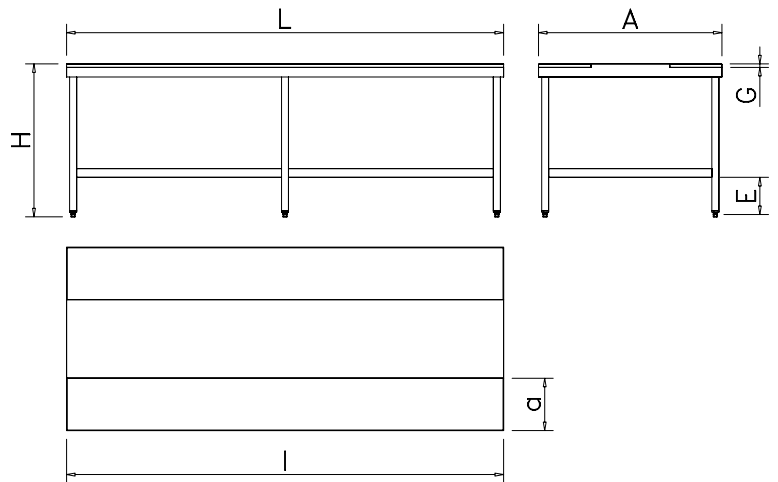

Es posible suministrarlas con fibra de diferente color. (Consultar)

There is the possibility of supplying them with other colours of fibre. (Ask for it)
Possibilité d'en fournir avec autres couleurs de fibre. (Demandez)

L	A	H	I	a	G	E	Kg		€	Kg		€
1.500	1.050	850	1.500	300	20	200	78	072402 072452	1.792,00	65	072602 072652	1.792,00
2.000	1.050	850	2.000	300	20	200	105	072404 072454	2.105,00	86	072604 072654	2.105,00
1.500	1.300	850	1.500	300	20	200	91	072410 072460	1.988,00	73	072610 072660	1.988,00
2.000	1.300	850	2.000	300	20	200	125	072412 072462	2.289,00	97	072612 072662	2.289,00



Repuestos de fibras.
Spare cutting boards.
Plaques de découpe.

78

Contenedor inox para vaciado de bandejas de comida rápida fast-food

Stainless steel waste bin for fast food restaurants

Poubelle en acier inoxydable spéciale snack restauration rapide Fast-food



Apertura a pedal
Foot pedal opening
Ouverture à pédale



080662

080660

Características de fabricación:

Fabricado totalmente con acero inoxidable. Sistema patentado de pedal. Permitirá al usuario abrir la trampilla sin necesidad de usar las manos. La trampilla también se puede abrir con la mano en caso de requerirlo. Las varillas de la parte superior del mueble facilitan la colocación de las bandejas. La tolva de caída de los desperdicios es de una sola pieza y no posee juntas ni huecos, lo que facilita la limpieza. Asa de la puerta ergonómica. El contenedor posee dos ruedas, lo que permite desplazarlo con poco esfuerzo. Provisto de dos tacos regulables en altura para adaptarse a cualquier clase de suelo, evitando desplazamientos accidentales o no deseados. Insonorizado en todas sus piezas.

Manufacturing characteristics:

Fully made of stainless steel. Pedal operated patented system. It will allow the user to open the lid avoiding the use of his hands. The lid can also be opened with the hand if necessary. Rods on the top that make easier the placing of the empty trays. Receptacle for scraps made in one only piece, without joints or hollows. Ergonomic handle. It can be moved effortlessly by means of two wheels. It can be adapted to any floor unevenness thanks to two adjustable blocks. All its components are soundproofed.



486074 36,00 393

Contenedor de plástico con tapa 55 lts
Plastic bin with lid 55 lts
Conteneur 55 lts



480662 19,00

Adhesivo trampilla
Sticker for lid
Autocollant pour trappe



486022 31,00 386

Contenedor de desperdicios 95 lts
Waste bin 95 lts
Conteneur à ordures 95 lts



480664 19,00

Adhesivo para pedal
Sticker for pedal
Autocollant pour pédale



485016 4,00

Ruedas
Wheels
Rouelles



- Incluido / Included / Inclus
- Opcional / Optional / Optionnel

Caractéristiques de fabrication:
Fabriqué totalement en acier inoxydable. Système patenté de pédale. Permettra à l'utilisateur ouvrir la trappe sans avoir besoin d'utiliser les mains. La trappe peut aussi être ouverte avec les mains. Les tiges de la partie supérieure du meuble facilitent le rangement des plateaux. La trémie de déchets est construite dans une seule pièce et elle ne possède pas de joints, ce qui facilite le nettoyage. Tireur ergonomique. La poubelle a deux rouelles, ce qui permet de la déplacer sans effort. Elle est pourvue de deux vérins réglables en hauteur pour s'adapter au plancher. Toute la poubelle est insonorisée.

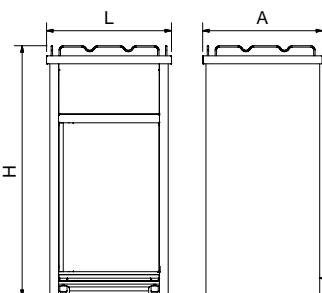

L	A	H	litros	Kg	Barcode	€
625	600	1.255	95 lt	46,0	080660	1.150,00
540	410	1.016	55 lt	30,5	080662	1.000,00

Boxes modulares

Modular boxes
Boxes modulaires



Con este sistema de boxes modulares ya puede configurar a su medida las mesas, fregaderos, estanterías, etc.

Basados en el sistema de medidas internacionales GASTRONORM (GN) están fabricados íntegramente en acero inoxidable. Su diseño moderno y funcional permite adaptar guías, cajones, cubetas, puertas etc.

Now you can tailor your tables, sinks, shelves and so on with this system of modular boxes.



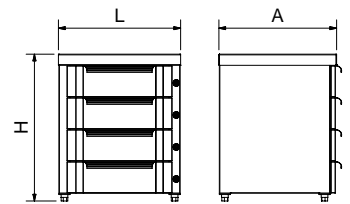

Based on the international dimensions Gastronorm, it is made totally from stainless steel. Its innovative and functional design allows the fitting of elements such as guides, drawers, pans, doors, etc.

Avec le système de boxes modulaires maintenant vous pouvez adapter à vos besoins tables, éviers, étagères, etc.

Ce système, basé dans les mesures internationales Gastronorm, est fabriqué totalement en acier inoxydable. Sa conception moderne et fonctionnelle permet d'adapter guides, tiroirs, bacs, portes, etc.



Posibilidad de acoplarles ruedas con y sin frenos. Wheels assembly possible, with or without brakes. Possibilité de mettre des roulettes avec et sans freins.

	L	A	H	H	GN	Kg	Barcode	€
 <p>Box modular 4 cajones Box 4 drawers unit Box modulaire 4 tiroirs</p>	439	423	530	600		19,00	075002	980,00
 <p>Box modular 1 cajón y puerta Box 1 drawer and door unit Box modulaire 1 tiroir et porte</p>	439	423	530	600		16,00	075004	932,00
 <p>Box modular guías GN Box GN guides unit Box modulaire GN guides</p>	439	423	530	600	2/3	10,00	075006	633,00
 <p>Box modular 1 puerta Box 1 door unit Box modulaire 1 porte</p>	439	423	530	600		13,00	075008	713,00

Kit golpeador para cajón modular

Coffee grounds striker kit for modular drawer

Kit de barre pour vider le marc de café pour tiroir modulaire



Valido solo para cajones Fricosmos.
Valid only for Fricosmos drawers.
Valable uniquement pour les tiroirs Fricosmos.



		€
Precio con montaje en fábrica Assembly price Prix pour accoupler	075020	100,00

L	A	H	Kg		€
330	75,5	89	2,1	275128	80,00

Estanterías de sobremesa

Worktop shelves

Etagères à poser sur table



Estantes regulables en altura
Adjustable shelves
Etagères réglables en hauteur

Entrepasño opcional
Optional shelf
Tablette en option

€

 081802 25,00 462

Porta-notas mural
Wall mounted tab grabber
Porte-notes mural



Op
 085014 4 X 10€

Kit de fijación
Fixing kit
Kit de fixation

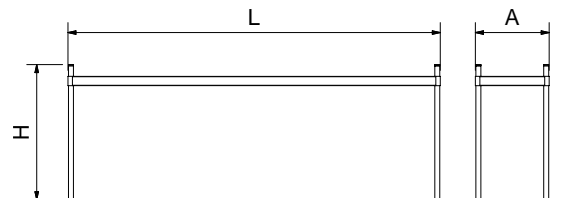
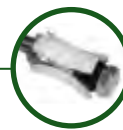

Instalación de sobremesa con o sin fijación.
Installation on worktop with or without fixing.
Installation sur dessus avec ou sans fixation.

Incluido / Included / Inclus
 Opcional / Optional / Optionnel

		€			€			
L	A	H	Kg		€	Kg		€
991	391	677	3,8	076060	205,00	3,6	276060	111,00
1.391	391	677	5,1	076062	253,00	4,9	276062	136,00
1.891	391	677	6,7	076064	301,00	6,5	276064	164,00

Esteras suspendidas

Hanging wall shelves
Étagères suspendues



Fabricadas totalmente en acero inoxidable. Esta gama de estanterías suspendidas está diseñada para ayudarle a organizar su espacio de trabajo con seguridad e higiene.

Los estantes son regulables en altura y cuentan con reborde perimetral que dará seguridad al contenido del estante, evitando a su vez posibles derrames y caídas de objetos.

Sus detalles de fabricación proporcionan firmeza y seguridad a toda la estructura.

Totally made in stainless steel. This range of hanging wall shelves is designed to help you to organize your working space in a safe and hygienic way. Their shelves are height adjustable, and are provided with a perimeter flange that will allow a secure storage and will avoid any accidental edge leakage. The particular manufacturing features provide stability and robustness to the whole structure.

Fabriqué entièrement en acier inoxydable cette gamme de rayonnages suspendus est conçu pour vous aider à organiser votre espace de travail en total sécurité et hygiène.

Les étagères sont réglables en hauteur et ont un rebord qui donnera sécurité au contenu de l'étagère en empêchant les possibles déversements. Ces détails de fabrication fournissent fermeté et sécurité à toute la structure.

015400 4 X 49€

Kit de fijación a techo para estanterías suspendidas
Ceiling fixing kit for hanging shelves
Kit de montage pour plafond pour étagères suspendues



081802 25 462

Porta-notas mural
Wall-mounted tab grabber
Porte-notes mural

486024 24 389

Contenedor de desperdicios y reciclaje
Waste and recycling container
Conteneur à ordures et recyclage

276044 35 320

Adaptador contenedor desperdicios
Cutlery basket adaptor for service trolleys
Adaptateur de conteneurs pour chariots de service

454860 2,50 460

Cestillo de plástico para cubiertos
Plastic cutlery basket
Plateau à couverts en plastique

276042 18 320

Adaptador de cestillos cuberteros
Container adaptor for service trolleys
Adaptateur de panier à utensiles de cuisine pour chariots de service

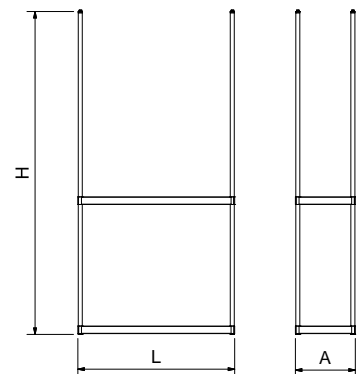

Incluido / Included / Inclus
Opcional / Optional / Optionnel

⚠ Posibilidad de añadir estantes adicionales. Preparado para atornillar mediante taco expansor.
Possibility of adding additional shelves. Ready for fixing with expansion shell anchors.
Des étagères supplémentaires peuvent être ajoutées.
Préparé pour le vissage au moyen d'un bouchon d'expansion.

L	A	H	Kg	Barcode	€	Kg	Barcode	€
991	391	2.000	8,0	015402	323,00	3,6	276060	111,00
1.391	391	2.000	10,6	015404	391,00	4,9	276062	136,00
1.891	391	2.000	13,8	015406	469,00	6,5	276064	164,00

Calentador de platos para estante de sobremesa

Warming tray for desktop shelves
Bande chauffante pour étagères à poser sur table



	Tensión Voltage Tension	Frecuencia Frequency Frequence	Potencia Power Puissance			
L				Kg	Barcode	€
955	220 V	50 Hz	1.000 W	4,8	076070	529,00
1.355	220 V	50 Hz	1.500 W	6,0	076072	588,00
1.855	220 V	50 Hz	1.500 W	7,0	076074	647,00

Lámpara para calentar platos

Food warmer lamp
Lampe pour chauffer des plats

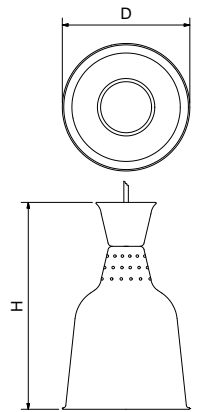

	Tensión Voltage Tension	Frecuencia Frequency Frequence	Potencia Power Puissance			
D H				Gr	Barcode	€
180 300	220 V	50 Hz	250 W	800	476090	97,00

Bombilla calentadora inastillable

Shatterproof heater bulb
Ampoule chauffante incassable



Tensión Voltage Tension	Frecuencia Frequency Frequence	Potencia Power Puissance		Kg	Barcode	€
220 V	50 Hz	250 W		200	476091	31,00
220 V	50 Hz	250 W		200	476088	35,00

Plafón para calentar platos

Commercial radiant heater for food warming
Plafond pour chauffer des plats



Características:

Válido para acoplarlo bajo encimera o estante, incluye fijaciones, también admite la posibilidad de suspenderlo mediante las cadenas incluidas.

Characteristics:

Possibility of being assembled under worktop or under shelf. It can also be hanged with the provided chains.

Caractéristiques:

Apte pour s'ajuster sous le plan de travail ou étagère, les fixations sont incluses. Peut aussi se suspendre avec les chaînes qui sont incluses.

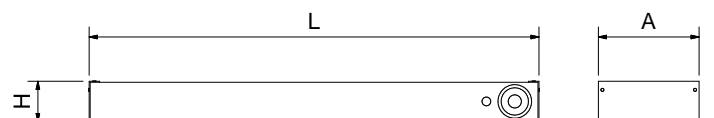

	Tensión Voltage Tension	Frecuencia Frequency Frequence	Potencia Power Puissance			
L A H				Kg	Barcode	€
613 113 65	220 V	50 Hz	575 W	5,0	476092	395,00

Calentador de platos mediante aire

Air flow dish warmer
Chauffe plats par air



Diseñado para ser instalado dentro de cualquiera de nuestros muebles o armarios con puertas, convirtiendo el mueble neutro en un mueble caliente a una temperatura constante, gracias a su termostato regulable entre 30 y 90 °C.

Designed to be installed inside any of our furniture or cabinets with doors, turning the neutral furniture into a hot furniture at a constant temperature, thanks to its adjustable thermostat between 30° and 90° C.

Conçu pour être installé dans n'importe lequel de nos meubles ou armoires avec portes, transformant le meuble neutre en un meuble chaud à température constante, grâce à son thermostat réglable entre 30° et 90° C.

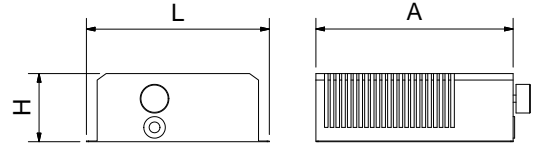

L	A	H	Tensión Voltage Tension	Frecuencia Frequency Frecuence	Potencia Power Puissance				€
275	230	95	230 V	50/60 Hz	2.000 W	185 m3/h.	3,50	476096	260,00

Dispensador de vasos

Cup dispenser
Distributeur de verres

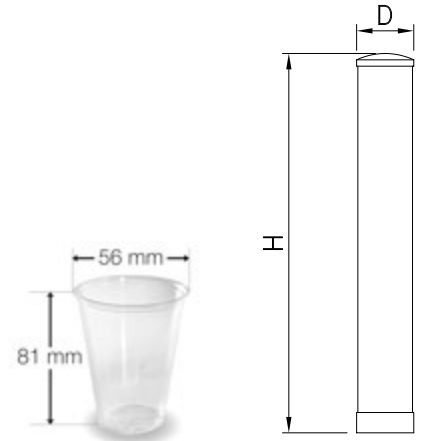

D	H			€
90	597	450	483270	102,00

Puerta rodante para contenedores

Rolling door for waste bin
Porte roulante pour conteneur

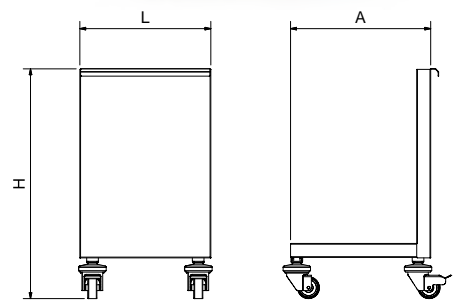

L	A	H			€
460	500	780	11	074472	350,00

Peto lateral reversible para mesas

Reversible side upstand for tables
Dossieret latéral réversible pour tables

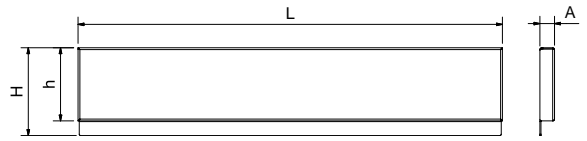

L	A	H	h	Kg	Barcode	€
480	20	120	100	0,98	070302	60,00
580	20	120	100	1,17	070304	63,00
680	20	120	100	1,37	070306	65,00

Tapa juntas de unión para mesas y fregaderos

Stainless steel flashing for tables and sinks
Couvre-joint pour union de tables et éviers

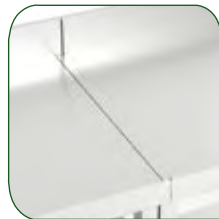

Características:

Válido para la unión entre mesas y/o fregaderos.

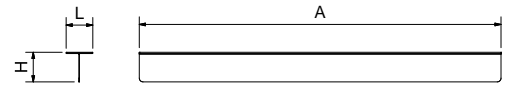

Characteristics:
Especially suitable for connecting tables and/or sinks.

Caractéristiques:
Valable pour l'union de tables et / ou éviers.

L	A	H	Gr	Barcode	€
475	35	39	320	074480	19,00
575	35	39	390	074482	19,00
675	35	39	460	074484	20,00

Fregaderos soldados a mesas

Sink units welded to tables
Evier soudés aux tables

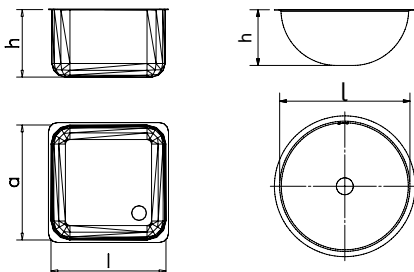

l	a	h	Barcode	€
260	Ø	115	057003	353,00
390	Ø	150	057005	385,00
370	340	145	057006	545,00
400	400	250	057008	420,00
400	400	300	057010	426,00
500	500	300	057012	453,00
500	500	350	057014	442,00
600	450	300	057016	498,00
600	450	300	057017	616,00
600	450	350	057018	614,00
600	450	350	057019	614,00
600	500	300	057020	605,00
600	500	300	057021	559,00
600	500	350	057022	551,00
800	420	350	057024	875,00
800	420	350	057026	875,00
1.060	420	350	057028	909,00
1.060	420	350	057030	909,00

Campana extractora mural acero inoxidable

Wall-mounted stainless steel exhaust hood
Hotte de cuisine murale en acier inoxydable



Características:

Construidas en acero inoxidable.
Sin motor.
Bandeja recoge-grasas con válvula de desengrase.
Filtros inoxidables de 490x490x50 mm.

Characteristics:

Made of stainless steel.
Extractor fan motor not included.
Grease tray with valve for evacuation.
Stainless steel filters 490x490x50 mm.

Caractéristiques:

Fabriquées en acier inoxydable.
Sans moteur.
Bac de récupération des graisses avec vanne de dégraissage.
Filtres inoxidables 490x490x50 mm.

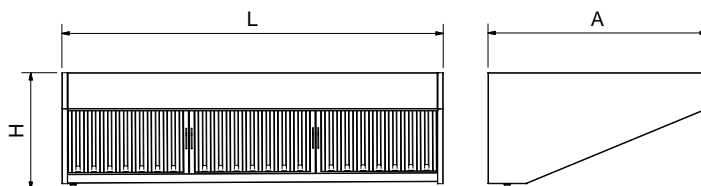

L	A	H				€
987	850	452	2	18,30	076602	589,00
1.477	850	452	3	24,40	076604	730,00
1.968	850	452	4	31,60	076606	809,00

Filtro inoxidable para campana extractora industrial

Stainless steel filter for commercial exhaust hood
Filtre inox pour hotte de cuisine industrielle



L	A	H			€
490	490	50	2,05	476702	25,00

Carros de servicio

Service trolley
Chariot de service



Características:

Concebido para un uso intensivo profesional.

Estantes regulables en altura. Pliegues reforzados con pestaña aplastada, lo que evita accidentes durante su uso y limpieza y aumenta la capacidad de carga hasta 140 kg por nivel. Posibilidad de añadir más estantes. Máxima carga admisible 280 kg.

Se suministra con 4 ruedas giratorias, dos de ellas con freno, diámetro 125 mm, provistas de superficie de rodadura de baja sonoridad.

Parachoques circulares de 95 mm de diámetro.



***HASTA 140 Kg**
de carga por estante
Up to 140 kgs of load
strength per shelf
Jusqu'à 140 kgs
de résistance par étage

Characteristics:

Designed for a heavy-duty professional use.

Adjustable shelves, reinforced by special fold with crushed fringe. This system avoids any bad cut when handling and cleaning it and increases its load strength. Every shelf can support up to 140 kgs evenly distributed. Possibility of increasing its number of shelves. Maximum load strength 280 kgs.

Provided with 4 castors of diameter 125 mm., 2 of them with brake, with tread band of low noise level.

Rounded bumpers of 95 mm. of diameter.

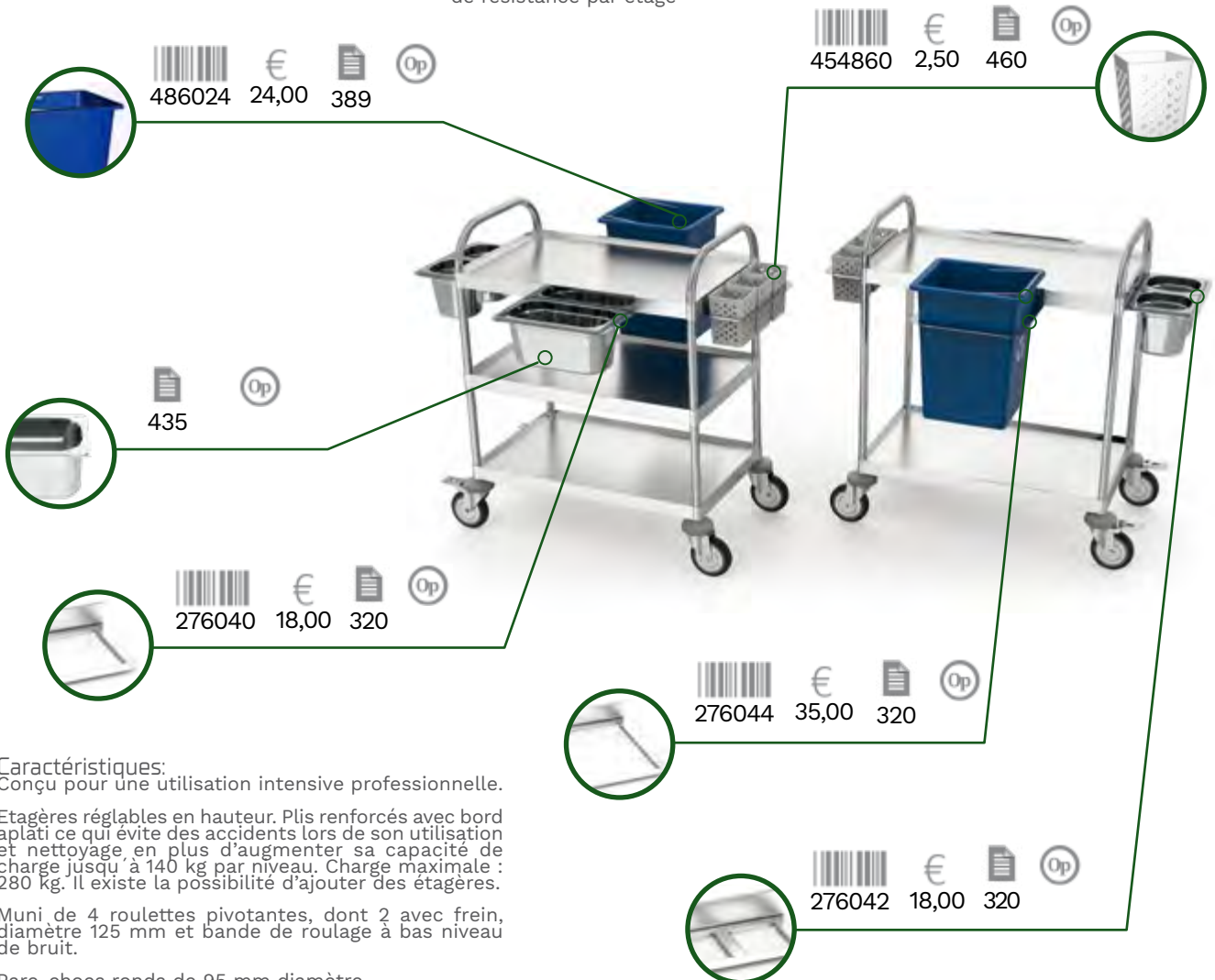

Caractéristiques:

Conçu pour une utilisation intensive professionnelle.

Etagères réglables en hauteur. Plis renforcés avec bord aplati ce qui évite des accidents lors de son utilisation et nettoyage, en plus d'augmenter sa capacité de charge jusqu'à 140 kg par niveau. Charge maximale : 280 kg. Il existe la possibilité d'ajouter des étagères.

Muni de 4 roulettes pivotantes, dont 2 avec frein, diamètre 125 mm et bande de roulage à bas niveau de bruit.

Pare-chocs ronds de 95 mm diamètre.

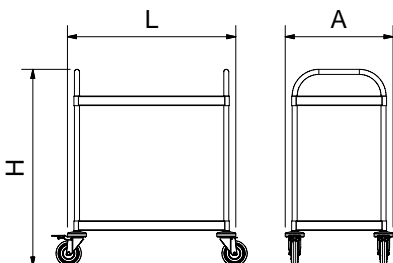

										Entrepaino opcional Optional shelf Tablette en option	
L	A	H	Kg	Kg	Barcode	€	Kg	Barcode	€		
835	535	975	140	15	076002	432,00	3,5	276050	84,00		
1.035	535	975	120	16	076004	444,00	4,3	276052	102,00		
1.235	535	975	120	18	076006	506,00	5,0	276054	125,00		

*El peso máximo soportado está calculado para una carga repartida uniformemente sobre toda la superficie del estante.
The weight capacity is calculated for an evenly distributed load over the entire surface of the shelf.
La capacité de charge est calculée pour une charge uniformément répartie sur toute la surface du plateau.

Adaptador de cubetas GN 1/3 y 1/6 para carros de servicio

Gastronorm trays adaptor GN 1/3 and 1/6 for service trolleys

Adaptateur de bacs Gastronorm 1/3 et 1/6 pour chariots de service

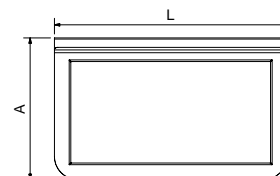

L	A	Gr	Barcode	€
355	216	780	276040	18,00

Adaptador de cestillos cuberteros para carros de servicio

Cutlery basket adaptor for service trolleys

Adaptateur de panier à utensiles de cuisine pour chariots de service

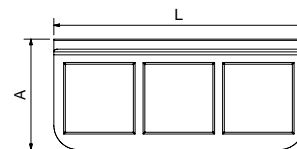

L	A	Gr	Barcode	€
360	159	792	276042	18,00

Adaptador de contenedores para carros de servicio

Container adaptor for service trolleys

Adaptateur de conteneurs pour chariots de service

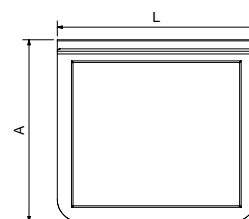

L	A	Gr	Barcode	€
315	289	764	276044	35,00

Carro de recogida

Collection trolley

Chariot de ramassage

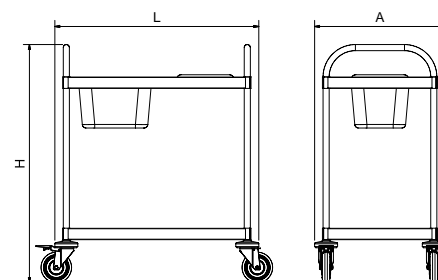

L	A	H	Kg	Barcode	€
835	535	975	15,5	076020	518,00
1.035	535	975	16,5	076022	540,00
1.235	535	975	18,5	076024	658,00

Mesa / Carro auxiliar multifuncional para instrumental o de servicio con ruedas

Multifunctional auxiliary table / trolley for equipment or service with wheels

Table / chariot auxiliaire multifonctionnel pour instruments ou service à roulettes

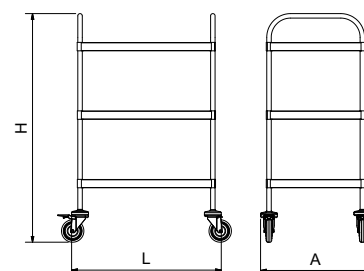

















L	A	H	Kg	Barcode	€
835	615	1.275	19,90	076010	650,00

Repuestos para carros de servicio y recogida

Spare parts for service and collection trolleys

Pièces de rechange pour chariots de service et ramassage

	Bastidor para carro de servicio Frame for service trolley Châssis pour chariot de service	1,8	276030	61,00					
	Entrepaño para carro de servicio de 800x500 mm. Shelf for service trolley of 800x500 mm. Étagère pour chariot de service de 800x500 mm.	3,5	276050	84,00					
	Entrepaño para carro de servicio de 1.000x500 mm. Shelf for service trolley of 1.000x500 mm. Étagère pour chariot de service de 1.000x500 mm.	4,5	276052	102,00					
	Entrepaño para carro de servicio de 1.200x500 mm. Shelf for service trolley of 1.200x500 mm. Étagère pour chariot de service de 1.200x500 mm.	5,5	276054	125,00					
	Rueda galvanizada con freno de diámetro 125 mm. Galvanized wheel of diameter 125 mm. with brake Roulette galvanisée avec frein diamètre 125 mm.	0,8	485010	21,00					
	Rueda galvanizada sin freno de diámetro 125 mm. Galvanized wheel of diameter 125 mm. without brake Roulette galvanisée sans frein diamètre 125 mm.	0,7	485012	17,00					
	Parachoques para carros de servicio Bumper for service trolleys Pare-chocs pour chariots de service	0,2	485050	5,00					
	Kit de acoplamiento de rueda a bastidor de carros de servicio Wheel fixing kit for service trolleys frame Kit d'accouplement de roulette pour châssis de chariots de service	0,12	085014	10,00					

	Rueda anticalórica con freno en acero inoxidable ø100 mm. Heat resistant swivel wheel with brake in stainless steel ø100 mm. Roulette résistante à la chaleur avec frein en acier inoxydable ø100 mm.	175 Kg.	-40 a 280°C	840	485026	70,00					
	Rueda anticalórica en acero inoxidable ø100 mm. Heat resistant swivel wheel in stainless steel ø100 mm. Roulette résistante à la chaleur en acier inoxydable ø100 mm.	175 Kg.	-40 a 280°C	840	485028	55,00					



Carro de manutención con ruedas y desagüe

Washing trolley with drain
Chariot à lavage avec écoulement



2 ruedas fijas y 2 giratorias de Ø 80 mm.

2 fixed wheels and 2 rotating wheels Ø 80 mm.

2 roues fixes et 2 roues tournantes Ø 80 mm.



481071 45,00



Tapa para carro de manutención 481070
Lid for washing trolley with drain 481070
Couvercle pour chariot de manutention 481070

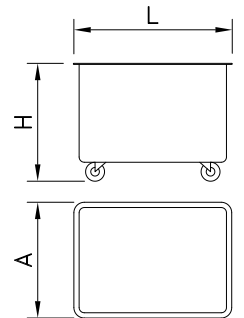

L	A	H	liters	Kg	Barcode	€
750	550	560	155	8,20	481070	273,00

Contenedor para transporte de hielo

Trolley for ice transportation
Conteneur à ordures

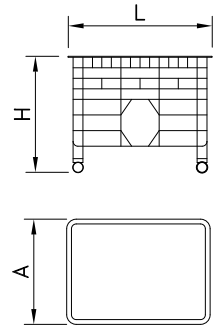

L	A	H	liters	Kg	Barcode	€
1.040	640	825	285 lts	19,50	481080	335,00

Contenedor para hielo

Trolley for ice transportation
Conteneur à ordures



Características:

Preparados para contacto alimenticio.
Fabricado en polietileno de alta densidad (HDPE).
Soporta temperaturas de -20°C hasta +70°C.
Con tapon para desagüe.

Characteristics:

Suitable for food contact.
Made of high-density polyethylene (HDPE).
It withstands temperatures from -20°C to +70°C.
With drain plug.

Caractéristiques:

Apte pour le contact alimentaire.
Fabriqué en polyéthylène de haute densité (HDPE).
Résiste à des températures allant de -20°C jusqu'à +70°C.
Avec bouchon pour l'évacuation.

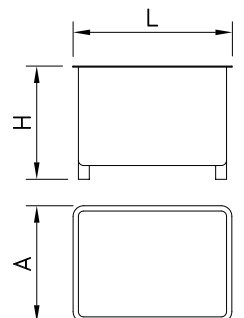

481074 394,00



Base rodante galvanizada
Galvanized rolling base
Base roulante galvanisée

L	A	H	liters	Kg	Barcode	€
790	600	685	210 lts	8,80	481072	336,00

Carro de lavado con desagüe en acero inoxidable

Washing trolley with drainage system in stainless steel
Chariot de lavage avec système d'évacuation en acier inoxydable

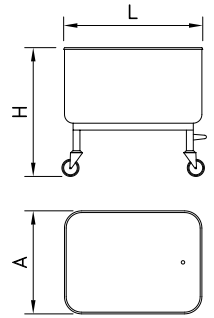

L	A	H	h	kg	Barcode	€
800	600	750	200	11,00	481082	672,00

Carro bañera para elevador

Tote bin for lift
Chariot baignoire pour élévateur

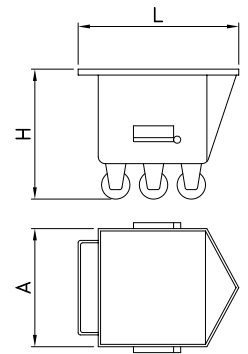

L	A	H	h	kg	Barcode	€
690	680	700	200	40	481078	850,00

Carros Gastronorm

Gastronorm trolleys
Chariots Gastronorm



Características:

4 ruedas giratorias, 2 de ellas con freno.

Characteristics:

4 swivel wheels, 2 of them with brakes.

Caractéristiques:

4 roues pivotantes, dont 2 avec freins.

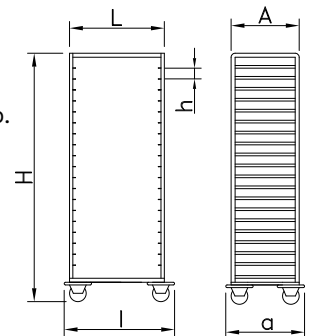

L	A	H	h	a	l	EN	kg	Barcode	€	
380	550	990	80	695	535	1/1	7	15	476016	260,00
380	555	1.725	78	700	535	1/1	20	16	476020	349,00
585	670	1.865	78	740	655	2/1	20	21	476022	390,00

Carro Euronorm

Euronorm tray trolley
Chariot pour plateaux Euronorm



Características:

4 ruedas giratorias, 2 de ellas con freno.

Characteristics:

4 swivel wheels, 2 of them with brakes.

Caractéristiques:

4 roues pivotantes, dont 2 avec freins.

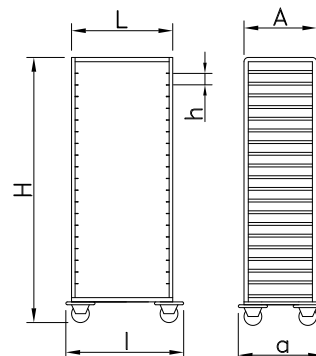

L	A	H	a	l	h	🔧	Kg	📊	€
465	630	1.725	700	535	78	20	19	476010	350,00

Carro bandejero multinorma (Gastronorm / Euronorm / Pastelería)

Multi-standard tray trolley (Gastronorm / Euronorm / Pastry)
Chariot à plateaux multi-standards (Gastronorm / Euronorm / Pâtisserie)

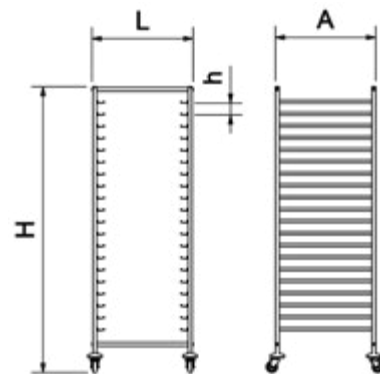

L	A	H	h	🔧	Kg	📊	€
666	661	1.888	78	20	27	076030	960,00



Rueda anticalórica con freno en acero inoxidable \varnothing 100 mm 
Heat resistant swivel wheel with brake in stainless steel \varnothing 100 mm
Roulette résistante à la chaleur avec frein en acier inoxydable \varnothing 100 mm

175 Kg. -40 a 280°C 840 485026 **70,00**



Rueda anticalórica en acero inoxidable \varnothing 100 mm 
Heat resistant swivel wheel in stainless steel \varnothing 100 mm
Roulette résistante à la chaleur en acier inoxydable \varnothing 100 mm

175 Kg. -40 a 280°C 840 485028 **55,00**

Funda reutilizable para carro de pastelería Euronorm

Reusable cover for Euronorm pastry trolley
Housse réutilisable pour chariot à pâtisserie Euronorm



L	A	H	Kg	Barcode	€
495	700	1.700	1	476006	252,00

Caja de 50 fundas desechables para carro de Euronorm / Gastronorm

Box of 50 disposable covers for Euronorm / Gastronorm trolley
Boîte de 50 housses jetables pour chariot Euronorm / Gastronorm



L	A	H	Kg	Barcode	€
400	600	1.800	1	476008	111,00

Carro de transporte

Platform trolley
Chariot à plate-forme

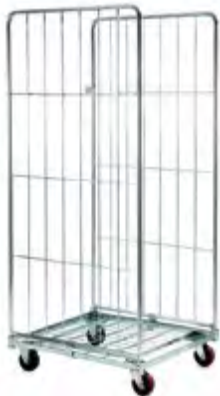

Características:

Acabado en cincado electrolítico.
2 ruedas giratorias y 2 fijas.

Characteristics:

Electrolytic zinc finishing.
2 swivel wheels and 2 fixed wheels.

Caractéristiques:

Finition en zinc électrolytique.
2 roues pivotantes et 2 roues fixes.

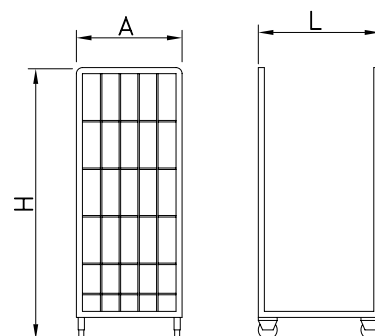

L	A	H	Kg	Kg	Barcode	€
700	800	1.800	600	22	476002	237,00

Carro de plataforma inox con asa retráctil

Platform stainless steel trolley with retractable handle
Chariot à plateforme inox avec poignée rétractable

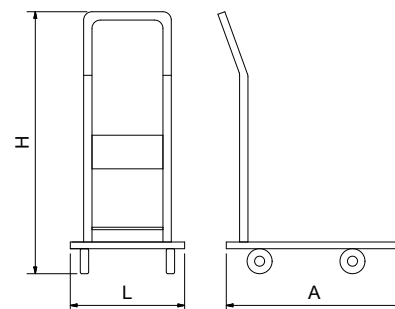

L	A	H	Kg	Kg	Barcode	€
490	760	840	300	9,4	480252	249,00

Palet para jamones

Palet for cured hams

Palette pour jambons



496



Ruedas
Wheels
Rouelles

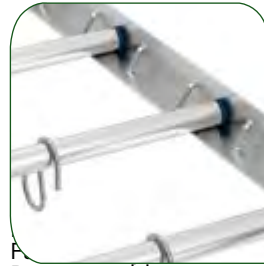

Los precios de los crochets del código 022702.
El cliente puede regular la altura de colocación de los tubos en cada nivel.
Posibilidad de añadir tubos adicionales.
Stackable up to 2 pallets.

Desmontable.

Máxima capacidad de carga por palet: 300 Kgs. Uniformemente repartidos entre todos los niveles y en el nivel.
Máxima capacidad de carga por palet remontando: 150 Kgs. Uniformemente repartidos entre los dos palets, entre todos los niveles y en cada nivel.

Se puede manejar con transpaleta.

Construido en acero galvanizado.

Posibilidad de acoplar ruedas.



Characteristics:

3 levels.
1st and 3rd levels: 4 tubes.
2nd level: 3 tubes.
Total: 11 tubes and 55 hooks ref. 022702.
The customer has the possibility of adjusting the height of the levels and placing the tubes on each level.
Possibility of adding additional tubes.
Stackable up to 2 pallets.
Easy to move.
Detachable.
Maximum load strength, non-stacked: 300 kgs evenly distributed on each level.
Maximum load strength, stacked: 150 kgs evenly distributed on each level.
It can be transported with a forklift.
Made in Galvanized steel.
Possibility of wheels assembly.

Caractéristiques:

Elle a 3 niveaux.
1^{er} et 3^{er} niveau: 4 tubes.
2^e niveau: 3 tubes.
Total: 11 tubes et 55 crochets 022702.
Possibilité de régler la hauteur des niveaux et l'emplacement des tubes à chaque niveau.
Possibilité d'ajouter des tubes supplémentaires.
Remontable-Maximum 2 palettes.
Transport facil.
Démontable.
Capacité max de charge par palette: 300 Kgs. Uniformément répartis entre tous les niveaux et sur le niveau.
Capacité max de charge par palette remontante: 150 Kgs. Uniformément répartis entre tous les niveaux et sur le niveau.
On peut la manipuler avec transpalette.
Fabriquée en acier galvanisé.
On peut ajouter des rouelles.

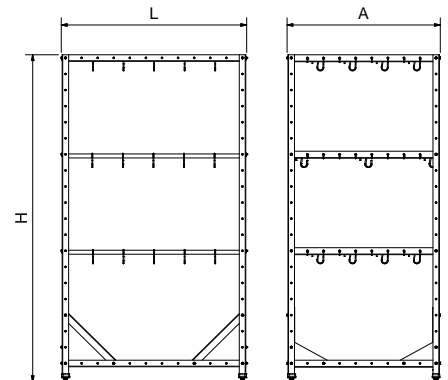

L A H Kg €

1.153 953 2.033 46 076040 596,00

Palet para embutidos

Pallet for sausages and cured meat
Séchoir charcuterie démontable en palette



496

Ruedas
Wheels
Rouelles



Características:

4 niveles y 6 tubos por nivel.
Regulación en altura de los niveles y tubos.
Posibilidad de añadir tubos adicionales.
Remontable. Máximo 2 palets.
Fácil transporte.
Desmontable.
Máxima capacidad de carga por palet: 300 KGS. Uniformemente repartidos entre todos los niveles y en el nivel.
Máxima capacidad de carga por palet remontando: 150 KGS Uniformemente repartidos entre los dos palets, entre todos los niveles y en cada nivel.
Se puede manejar con transpaleta.
Construido en acero galvanizado.

Characteristics:

4 levels and 6 tubes per level.
The levels and tubes can be adjusted.
Possibility of mounting additional elements.
Stackable up to 2 pallets.
Easy to transport.
Detachable.
Maximum load strength, non-stacked: 300 kg per pallet, evenly distributed on each level.
Maximum load strength, stacked: 150 kg per pallet, evenly distributed on each level.
Can be transported with a forklift.
Made in galvanized steel.

Caractéristiques:

Il a 4 niveaux.
6 tubes par niveau, total 24 tubes.
Possibilité de régler la hauteur des niveaux par le client et possibilité de choisir l'emplacement des tubes dans chaque niveau.
Possibilité d'ajouter des tubes additionnels.
Possibilité d'empiler. Maximum 2 palettes.
Transport facile.
Démontable.
Capacité maximale de charge par palette: 300 kg uniformément repartis.
Capacité maximale de charge par palette remontée: 150 kg uniformément repartis.
On peut le transporter avec transpalette.
Fabriqué en acier galvanisé.

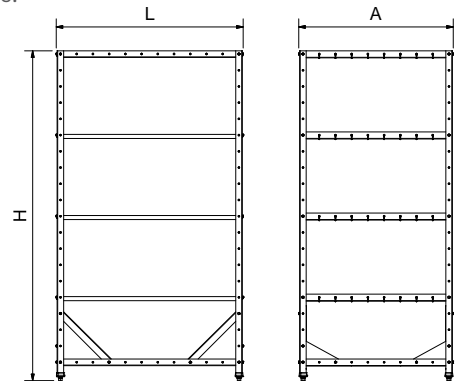

L	A	H	Kg	Barcode	€
1.153	953	2.033	55	076050	619,00

Carro para canales

Carcass trolley
Chariot à carcasses



Características:

4 ruedas giratorias.
Estante inferior móvil.
Estructura del tubo 40x40 mm.

Characteristics:

4 swivel wheels.
Detachable lower level.
Tube 40x40 mm.

Caractéristiques:

4 roues pivotantes.
Niveau inférieur amovible.
Tube 40x40 mm.



***HASTA 500 Kg**
Up to 500 kgs
Jusqu'à 500 kgs

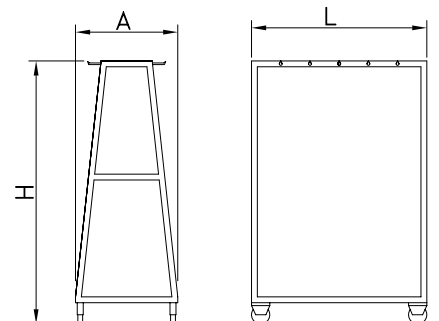

L	A	H	Kg	Barcode	€
1.200	700	1.800	38	476030	1.784,00



Mostrador de pescadería con soporte

Floor-mounted fish counter
Étal à poisson avec support



Tacos regulables
Protector frontal curvado transparente
Laterales transparentes
Bandejas perforadas
Desagües
Conectores rápidos desagües
Mangueras desagües
Puertas desmontables
Juego de adhesivos ola para los frentes

Adjustable blocks
Front and sides
of plastic
Perforated trays
Drainers
Quick connectors
hoses
Drains hoses
Rear detachable
doors
Set of decorative
stickers "Wave"

Taquets réglables
Front et flancs en
plastique
Plateaux perforés
Déversoirs
Connecteurs
rapide pour tuyaus
Tuyaus déversoirs
Portes postérieures
amovibles
Jeu d'autocollants
décoratives

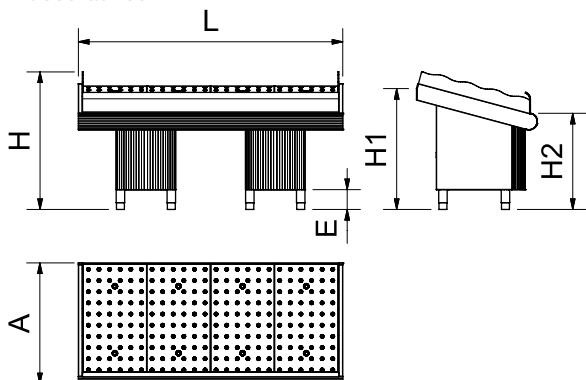

Características:

Fabricado totalmente con acero inoxidable AISI 304, está diseñado para adaptarse a las necesidades de los diferentes establecimientos.

Characteristics:

Wholly made of stainless steel AISI 304, it has been designed to meet the needs of any establishment.

Caractéristiques:

Fabriqué totalement en acier inoxydable AISI 304, c'est conçu pour subvenir les besoins de tous les établissements.

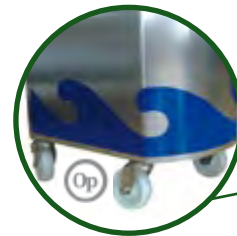

Mediante un novedoso sistema de bandejas conseguimos que el hielo permanezca sujeto a la exposición, evitando su desplazamiento hacia la parte delantera. A diferencia de otros expositores, con nuestro diseño ahorraremos energía y agua, pues con una capa menor de hielo conseguiremos exponer mejor el producto.

By means of a new trays system we achieve the ice to remain fixed to the counter and we avoid it to slide to the front side. Unlike other counters, with this new system we will save both water and energy, since with a thinner sheet of ice you will be able to exhibit your products in the best conditions.

Grâce à un nouveau système de plateaux nous atteindrons que le glace reste fixé au comptoir et nous évitons qu'elle se glisse vers la partie inférieure. Contrairement à autres étals, avec ce système vous épargnez de l'eau et de l'énergie, puisque avec une couche de glace plus fine vous pourrez exposer vos produits dans les meilleures conditions.



Mediante la regulación de los pies podemos incrementar la altura hasta 50 mm más.

By the adjustment of the legs you can increase the height up to 50 mm.

Par le réglage des pieds vous pouvez incrémenter l'hauteur jusqu'à 50 mm.



L	A	H	H1	H2	E	kg	Barcode	€
985	950	1.045	960	730	150	1	51 074439	1.450,00
1.465	950	1.045	960	730	150	2	78 074445	2.048,00
1.950	950	1.045	960	730	150	2	116 074440	2.400,00
2.912	950	1.045	960	730	150	2	120 074444	3.200,00

Optional / Optional / Optionnel

Mostrador de pescadería

Fish counter
Étal à poisson



Características:

Fabricado totalmente con acero inoxidable AISI 304, está diseñado para adaptarse a las necesidades de los diferentes establecimientos.

Characteristics:

Wholly made of stainless steel AISI 304, it has been designed to meet the needs of any establishment.

Caractéristiques:

Fabriqué totalement en acier inoxydable AISI 304, c'est conçu pour subvenir les besoins de tous les établissements.

Protector frontal curvado transparente
Laterales transparentes
Bandejas perforadas pescaderías
Desagües
Mangueras desagües

Front et flancs en plastique
Plateaux perforés
Déversoirs
Tuyaus déversoirs

Front and sides in plastic
Perforated trays
Drainers
Drain hoses

Mediante un novedoso sistema de bandejas conseguimos que el hielo permanezca sujeto a la exposición evitando su desplazamiento a la parte delantera. A diferencia de otros exposidores con nuestro diseño ahorraremos energía y agua pues con una capa menor de hielo conseguiremos exponer mejor el producto.



By means of a new trays system we achieve the ice to remain fixed to the counter and we avoid it to slide to the front side. Unlike other counters, with this new system we will save both water and energy, since with a thinner sheet of ice you will be able to exhibit your products in the best conditions.

Grâce à un nouveau système de plateaux nous atteindrons que le glace reste fixe au comptoir et nous évitons qu'elle se glisse vers la partie inférieure. Contrairement à autres étals, avec ce système vous épargnez de l'eau et de l'énergie, puisque avec une couche de glace plus fine vous pourrez exposer vos produits dans les meilleures conditions.

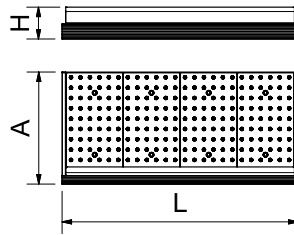
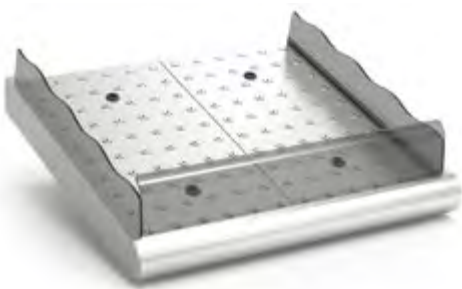

L	A	H	Kg	Barcode	€
985	950	270	25	074441	850,00
1.465	950	270	33	074447	1.208,00
1.950	950	270	48	074442	1.350,00
2.912	950	270	70	074446	2.150,00

Prolongación modular para mostrador de pescadería

Modular extension for fish counter
Extension modulaire pour étal à poisson



Contenido:
Tacos regulables
Laterales transparentes
Dos bandejas perforadas

Included:
Adjustable feet
Transparent sides
Two perforated trays

Inclus:
Pieds réglables
Côtés transparents
Deux plateaux perforés

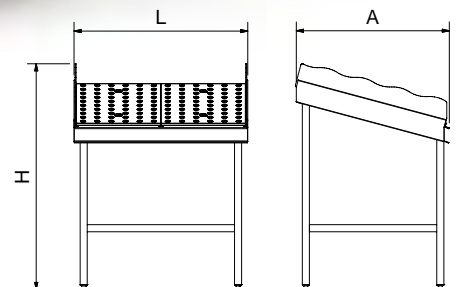

Características:

Con esta ampliación modular del mostrador podrá duplicar la zona de exposición en la zona que más le interese. Desmontable, movable y regulable en altura.

Characteristics:

This modular extension will allow you make double your display space at the required area. It is detachable, movable and with adjustable height.

Caractéristiques:

Cette extension modulaire vous permettra doubler votre espace d'exposition à la zone nécessaire. Elle est amovible, mobile et réglable en hauteur.

L	A	H	Kg	Barcode	€
985	867	1.279	29,5	074462	990,00



074444 3.200,00 328



Mostrador de pescadería con soporte
Floor-mounted fish counter
Étal à poisson avec support



074462 990,00 329



Prolongación modular para mostrador de pescadería
Modular extension for fish counter
Extension modulaire pour étal à poisson

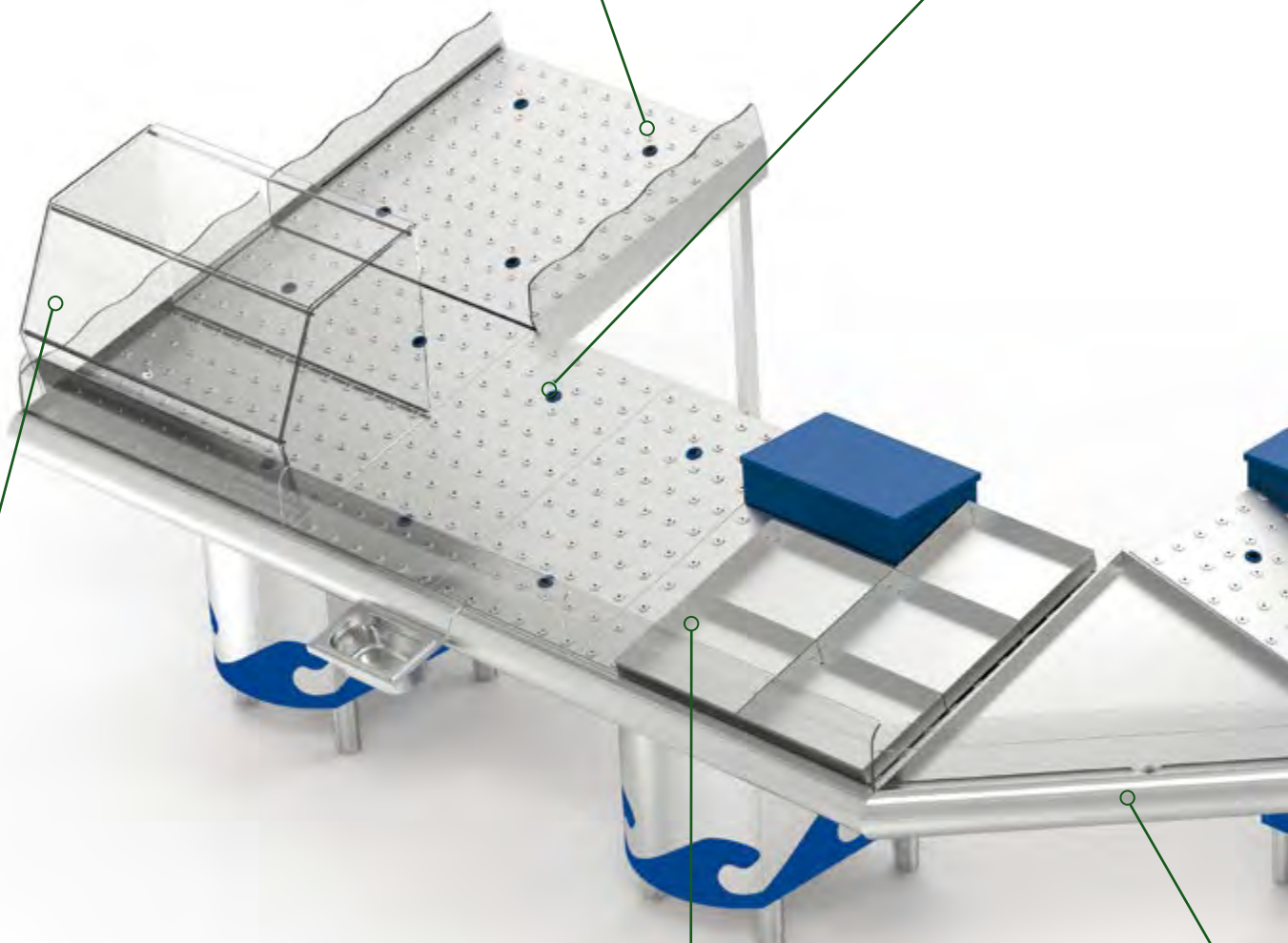

Cubierta protectora para mostrador de pescadería
Sneeze screen for fish counter
Vitre de protection pour étal à poisson

L	A	H	Kg		€
960	500	572	4,80	074464	353,00

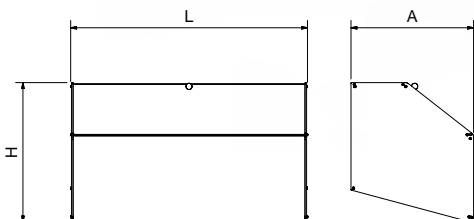
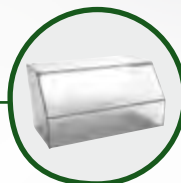

083420 39,00 452



Bandeja para marisco
Seafood tray
Plateau inox pour fruits de mer

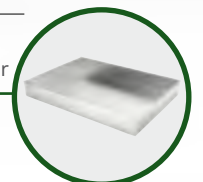



074460



190,00



336



Tajo-expositor para mostrador de pescadería
Polyethylene cutting board-display for fish counter
Plaque de découpe-exposant en polyéthylène pour étal à poisson

Unión en escuadra interior para mostradores de pescadería
Fish counter interior corner link
Jonction d'angle interne pour étal à poisson

L	A	H	Kg	Barcode	€
1.230	870	118	8,00	074449	368,00

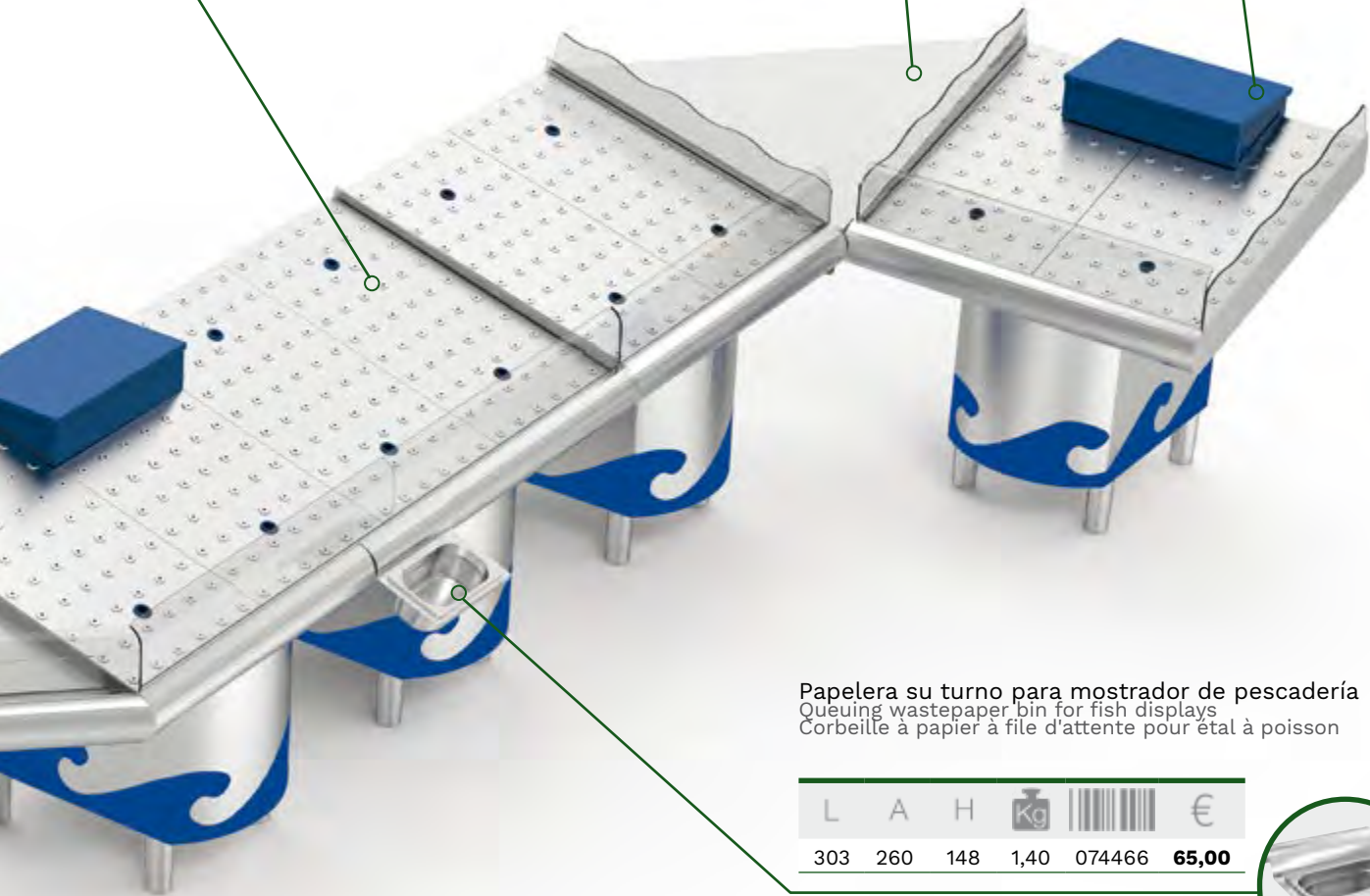
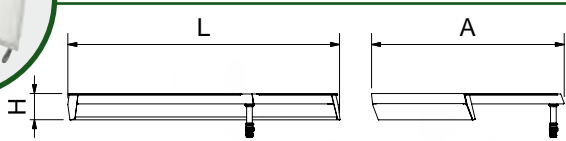
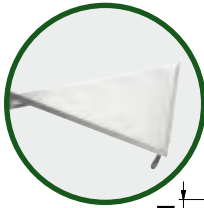

Papelera su turno para mostrador de pescadería
Queuing wastepaper bin for fish displays
Corbeille à papier à file d'attente pour étal à poisson

L	A	H	Kg	Barcode	€
303	260	148	1,40	074466	65,00

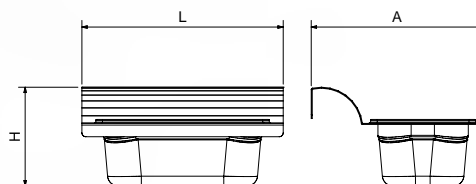
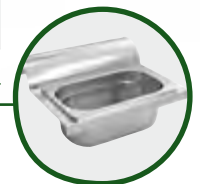

Unión en escuadra exterior
Fish counter exterior corner link
Jonction d'angle pour étal à poisson



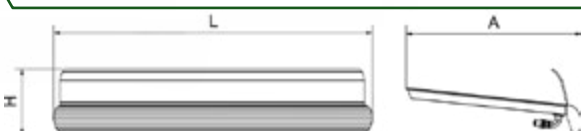
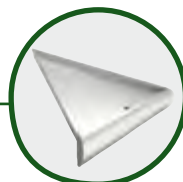







L	A	H	Kg	Barcode	€
1.290	960	256	11,00	074448	546,00



Repuestos para mostradores de pescadería

Spares parts for fish counter

Rechanges pour étals à poisson

			Gr	€
	Frontal curvado transparente de 963 mm. Curved transparent front panel 963 mm. Panel courbe transparent 963 mm.	550	274490	71,00
	Lateral transparente Transparent side panel Panel latéral	410	374460	34,00
	Bandeja perforada para mostrador de pescadería Perforated tray for fish counter Plateau perforé pour comptoir à poisson	3.000	274476	80,00
	Pie regulable inox de Ø 63,5x150 mm. Adjustable stainless foot ø63,5x150 mm. Pied réglable inoxydable ø63,5x150 mm.	200	409856	10,00
	Adhesivo modelo "Ola" "Wave" model sticker Autocollant modèle "vague"	80	474468	30,00
	Adhesivo hierba. Sticker "Grass". Adhésif gazon.	90	474466	30,00
	Desagüe de poliamida blanca 3/4" L=90 mm. White polyamide drain 3/4" L=90 mm. Déversoir en polyamide 3/4" L=90 mm.	90	474460	2,50
	Abrazadera sin fin de 25-40 mm. para manguera Worm drive hose clamp 25-40 mm. Collier de serrage sans fin de 25-40 mm pour tuyau	5	460453	1,30
	Manguera flexible de 1" Flexible hose 1" Tuyau flexible 1"		474478	4,00
	Pasacable azul Ø 36x2,5 mm. Blue passcable Ø 36x2,5 mm. Passecâble bleu Ø 36x2,5 mm.	0,006	409830	0,79

Mesas de preparación y lavado

Preparation and cleansing tables
Tables de préparation et de lavage



Dotación y características de fabricación:
Totalmente construida con acero inoxidable.
Fibra de polietileno calidad P-500.
Fregadero soldado con válvula, tapón y rebosadero.
Tolva de evacuación de desperdicios.

Features and manufacturing characteristics:
Fully made of stainless steel.
P-500 quality polyethylene cutting board.
Welded bowl with valve, plug and overflow.
Hole for waste-chutes

Dotation et caractéristiques de fabrication:
Entièrement fabriquées en acier inoxydable.
Plaque découpe de polyéthylène qualité P-500.
Bac soudée avec valve, déversoir.
Trou pour tremie à déchets.



Repuestos de fibras.
Spare cutting boards.
Plaques de découpe.



78

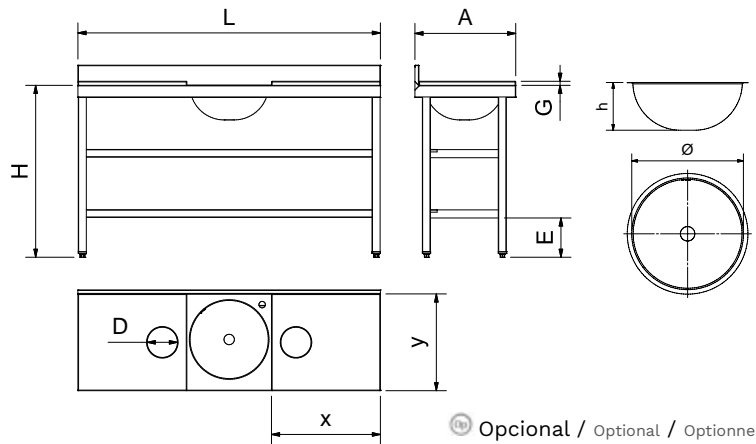

Optional / Optional / Optionnel

	L	A	H	E	Ø	h	X	y	G	D	Kg	€
	1.000	500	850	200	390	170	540	480	20	150	23,5	072802 072880 839,00 072852
	1.000	500	850	200	390	170	540	480	20	150	23,5	072810 072882 839,00 072860
	1.500	500	850	200	390	170	540	480	20	150	30,0	072812 072884 1.036,00 072862
	1.500	500	850	200	390	170	540	480	20	150	30,0	072820 072886 1.036,00 072870
	1.500	500	850	200	390	170	540	480	20	150	34,0	072822 072888 1.176,00 072872

Puesto pescadero encimera polietileno

Fish preparation table with polyethylene worktop
Table de preparation de poisson dessus en polyéthylène



Características:

Su peto trasero en plástico permite trabajar cómodamente de cara al público y evitar salpicaduras. El precio incluye el portacuchillos para adosar con envolvente.

Characteristics:

Plastic back fringe that allows to work conveniently face to the public and to avoid splashing. Provided with a mounted knife holder with housing.

Caractéristiques:

Pan coupé postérieur en plastique qui permet travailler commodément face au public et éviter des éclaboussures. Pourvu avec porte-couteaux pour adosar avec enveloppant.

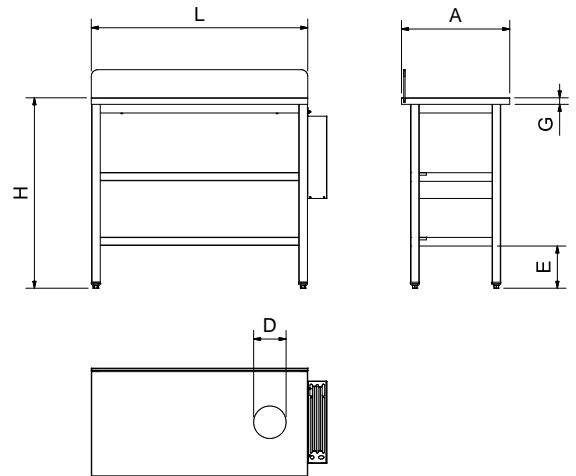

L	A	H	D	G	E	Kg	€
1.000	500	850	150	30	200	20	074424 600,00



Repuestos de fibras.
Spare cutting boards.
Plaques de découpe.



78

Puesto pescadero modelo sencillo

Fish preparation table simple model
Table de préparation de poisson modèle simple

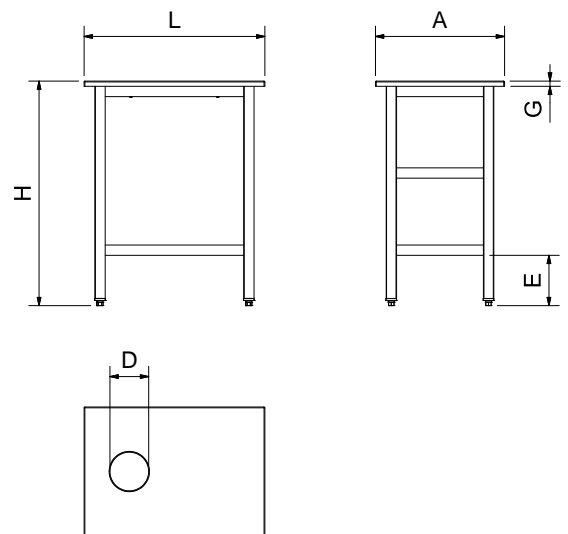

L	A	H	D	G	E	Kg	€
700	500	850	150	20	200	18	074404 074407 384,00 074406



Repuestos de fibras.
Spare cutting boards.
Plaques de découpe.



78

Mesa para marisco

Seafood table
Table pour fruits de la mer



074451 31,00

Separador para mesa de marisco
Separator for seafood table
Séparateur pour table pour fruits de la mer

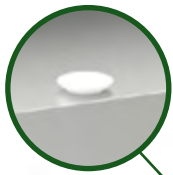
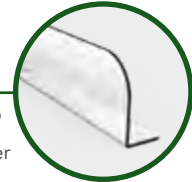

Ⓞ Opcional / Optional / Optionnel

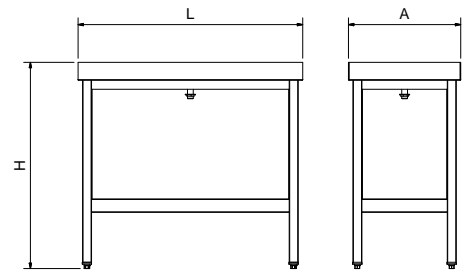

L	A	H	Kg	Barcode	€
1.000	500	917	27,2	074450	797,00

Mesa para cocción de marisco

Seafood boiling and cooling table
Table de cuisson pour fruits de mer



Características:

Cubeta GN 1/1 de 150 mm de profundidad con desagüe de vaciado incorporado.
Guías para desplazamiento de cubeta.
Ducha horno 463004.

Characteristics:

GN 1/1 container 150 mm depth, with built-in outlet drain.
Guides for the motion of the container.
Shower for oven 463004.

Caractéristiques:

Bac GN 1/1 de 150 mm de profondeur avec vidange.
Guides pour déplacement du bac.
Douchette four 463004.

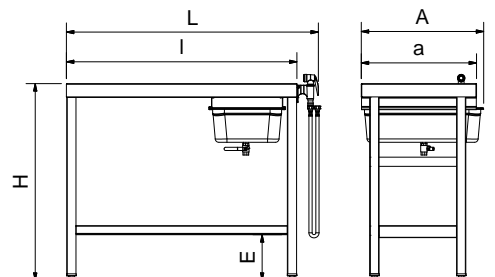

L	I	A	a	H	E	Kg	Barcode	€
1.095	1.000	530	500	850	200	29,67	074802	769,00

Tajo-expositor para mostrador de pescadería

Polyethylene cutting board-display for fish counter
Plaque de découpe-exposant en polyéthylène pour étal à poisson

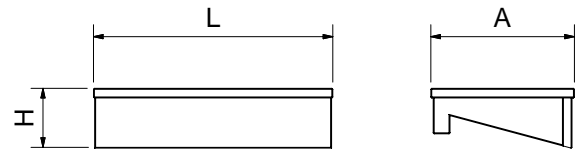
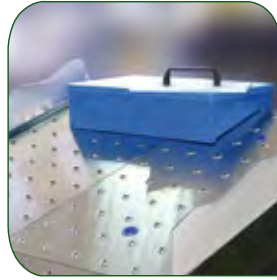

L	A	H	Kg	Barcode	€
500	300	125	4,70	074460	190,00

Paleta de fibra para aplastar hielo

Polyethylene trowel for crushing ice
Truelle en polyéthylène pour piler la glace

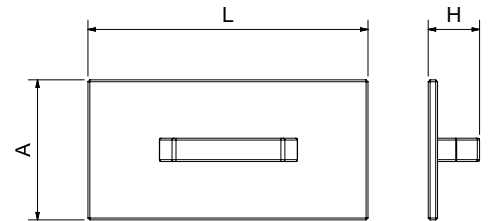

L	A	H	Gr	Barcode	€
300	150	55	500	032202	33,00

Pala para hielo

Ice spade
Pelle à glaçons



Características:

Su fabricación en polipropileno garantiza:
No absorbe agua.
No pierde su dureza en condiciones de humedad.
Puede ser esterilizado (no en autoclave).
Soporta temperaturas de hasta 100°C.

Characteristics:

It is made of polypropylene, which guarantees:
No water absorption.
No loss of hardness in humidity conditions.
Possibility of sterilization.
It resists temperatures up to 100°C.

Caractéristiques:

Sa fabrication en polypropylène garantit:
Pas d'absorption d'eau.
Pas de perte de dureté dans conditions d'humidité.
Possibilité de stérilisation.
Supporte température jusqu'à 100°C.

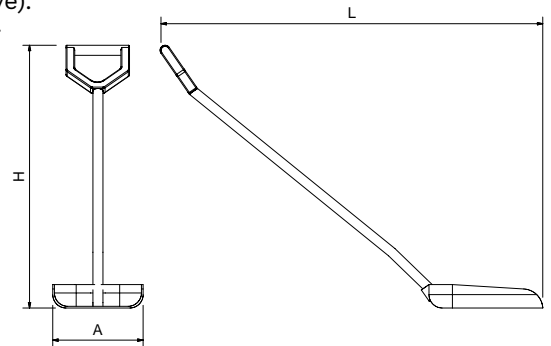

L	A	H	Kg	Barcode	€
1.107	279	890	1,5	474458	93,00

Pala de mano para hielo

Ice shovel
Pelle à glaçons



Characteristics:

It is made of polypropylene, which guarantees:
No water absorption.
No loss of hardness in humidity conditions.
Possibility of sterilization.
It resists temperatures up to 100°C.

Caractéristiques:

Sa fabrication en polypropylène garantit:
Pas d'absorption d'eau.
Pas de perte de dureté dans conditions d'humidité.
Possibilité de stérilisation.
Supporte température jusqu'à 100°C.

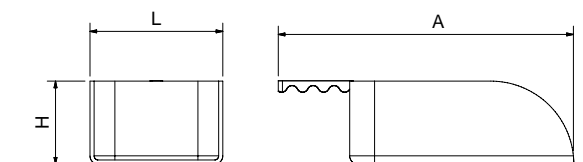

L	A	H	Gr	Barcode	€
160	340	90	150	474456	12,00

Expositor de frutas y verduras inox con ruedas

Stainless steel fruit and vegetable display rack with wheels

Présentoir de fruits et légumes en acier inoxydable avec roulettes



Fabricado en acero inoxidable AISI 304 este expositor de frutas y verduras es ideal para cualquier frutería o supermercado, gracias a que se trata de una solución modular, escalable, resistente y duradera.

El expositor está diseñado para colocar dos cestas alimentarias estándar de 600x400 mm apoyadas sobre sus pestañas interiores. Sus frutas y verduras quedarán perfectamente expuestas gracias a esta solución.

Incorpora cuatro ruedas, dos de ellas con freno para facilitar que el expositor mantenga la posición deseada.

* Este artículo se entrega desmontado. Incluye tornillería.

Made of AISI 304 stainless steel, this fruit and vegetable display is ideal for any greengrocer or supermarket, thanks to the fact that it is a modular, scalable, resistant and durable solution.

This display rack has been designed to lodge two standard 600x400 mm food baskets docked on their supporting brackets. Your fruits and vegetables will be perfectly displayed thanks to this solution. It is fitted with four wheels, two of them with brakes to make it easier for the display to keep the desired position.

* This item is delivered disassembled. Screws included.



Fabriqué en acier inoxydable AISI 304, ce présentoir de fruits et légumes est idéal pour tout marchand de légumes ou supermarché, car il s'agit d'une solution modulaire, évolutive, résistante et durable.

Le présentoir est conçu pour placer deux paniers alimentaires standard de 600x400 mm reposant sur leurs languettes intérieures. Vos fruits et légumes seront parfaitement exposés grâce à cette solution.

Il intègre quatre roues, dont deux avec freins pour faciliter le maintien de la position souhaitée par l'exposant.

* Cet article est livré démonté. Visserie incluse.

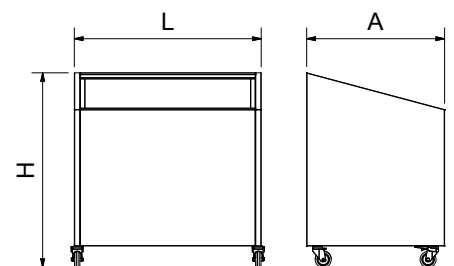

L	A	H	Kg	€
864	638	900	18,5	075610 300,00

Mostrador frutería

Floor-mounted vegetable counter
Comptoir fruits et légumes



Características:

Fabricado totalmente con acero inoxidable AISI 304, está diseñado para adaptarse a las necesidades de los diferentes establecimientos.

Characteristics:

Wholly made of stainless steel AISI 304, it has been designed to meet the needs of any establishment.

Caractéristiques:

Fabriqué totalement en acier inoxydable AISI 304, c'est conçu pour subvenir les besoins de tous les établissements.

Tacos regulables
Desagües
Mangueras desagües
Puertas desmontables
Juego de adhesivos hierba para los frentes

Adjustable blocks
Drainers
Drains hoses
Rear detachable doors
Set of decorative stickers "Hierba"

Taquets réglables
Déversoirs
Tuyaus déversoirs
Portes postérieures amovibles
Jeu d'autocollants décoratives



Mediante la regulación de los pies podemos incrementar la altura hasta 50 mm más.

By the adjustment of the legs you can increase the height up to 50 mm.

Par le réglage des pieds vous pouvez incrémenter l'hauteur jusqu'à 50 mm.

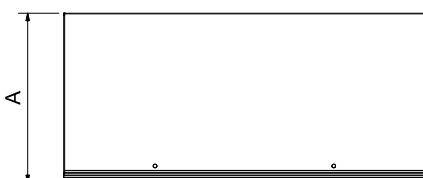
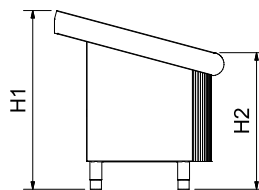
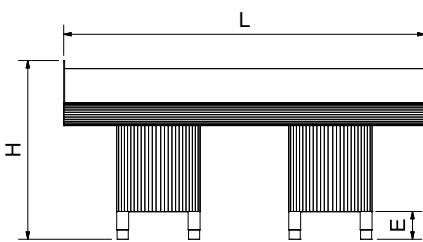

L	A	H	H1	H2	E		Kg		€
985	950	1.045	960	730	150	1	39,0	075630	1.150,00
1465	950	1.045	960	730	150	2	69,0	075632	1.575,00
1948	950	1.045	960	730	150	2	76,5	075634	1.880,00
2911	950	1.045	960	730	150	2	90,5	075636	2.400,00

Opcional / Optional / Optionnel

Mostrador frutería sobre obra

Vegetable counter to be fitted on a built-in stand
Comptoir fruits et légumes de chantier

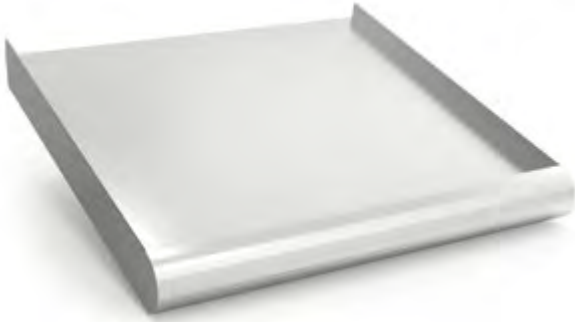

Características:

Fabricado totalmente con acero inoxidable AISI 304, está diseñado para adaptarse a las necesidades de los diferentes establecimientos.

Characteristics:

Wholly made of stainless steel AISI 304, it has been designed to meet the needs of any establishment.

Caractéristiques:

Fabriqué totalement en acier inoxydable AISI 304, c'est conçu pour subvenir les besoins de tous les établissements.

Tacos regulables
Desagües
Mangueras desagües

Adjustable blocks
Drainers
Drains hoses

Taquets réglables
Déverseurs
Tuyaus déverseurs



L	A	H	Kg	Barcode	€
985	950	120	16	075620	550,00
1465	950	120	23	075622	735,00
1948	950	120	30	075624	850,00
2911	950	120	44	075626	1.350,00

Separador para mostrador de frutería / pescadería

Divider for vegetable / fish counter
Séparateur pour comptoir de Fruiterie /Poissonnerie

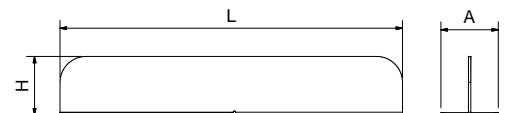

L	A	H	Kg	Barcode	€
860	144	147	1,7	075638	88,00



075636



2.400,00



338



Mostrador frutería
Floor-mounted vegetable counter
Comptoir fruits et légumes

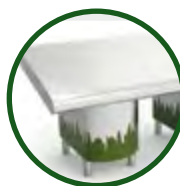

074462



990,00



329



Prolongación modular
Modular extension
Extension modulaire



Unión en escuadra exterior
Fish counter external corner link
Jonction d'angle pour étal à poisson

L A H Kg



€

1.290 960 256 11,00 074448 **546,00**

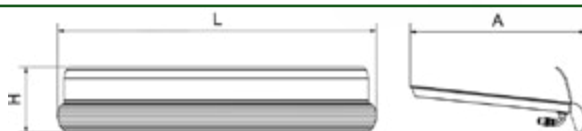
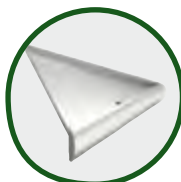



456

Cestas alimentarias
Food baskets
Paniers alimentaires



Unión en escuadra interior
Interior corner link
Jonction d'angle interne

L	A	H	Kg	Barcode	€
1.230	870	118	8,00	074449	368,00

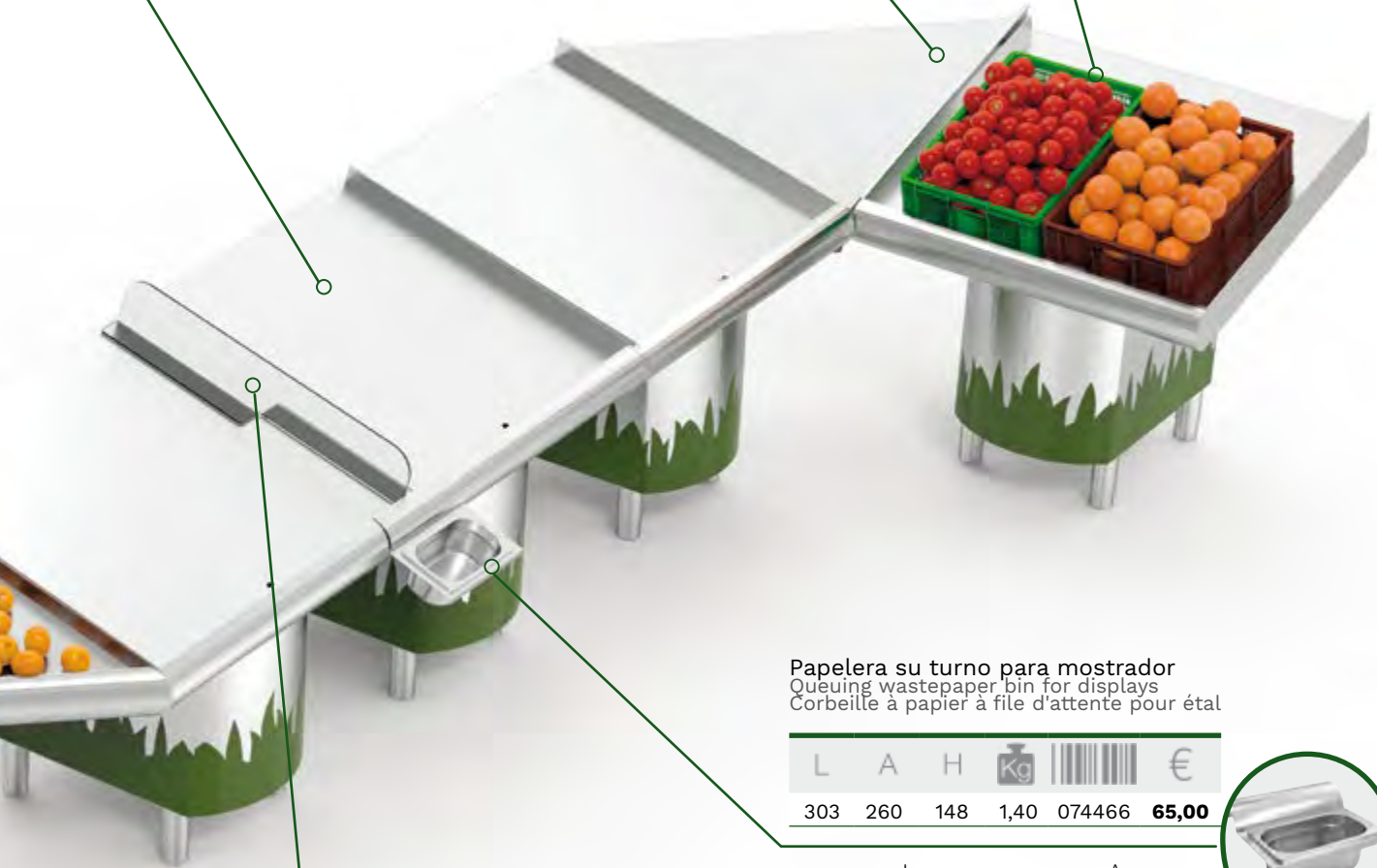
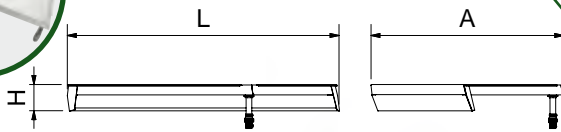
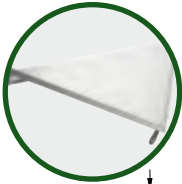

Papelera su turno para mostrador
Queuing wastepaper bin for displays
Corbeille à papier à file d'attente pour étal

L	A	H	Kg	Barcode	€
303	260	148	1,40	074466	65,00

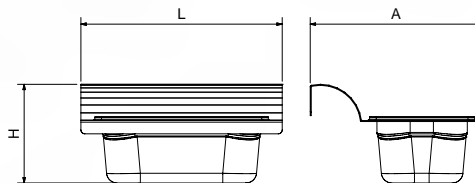
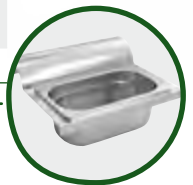

Barcode	€	Document	Optional
075638	88,00	339	

Separador para mostrador de frutería / pescadería
Divider for vegetable / fish counter
Séparateur pour comptoir de Fruiterie /Poissonnerie

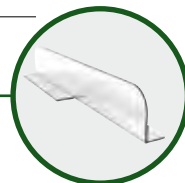

Armarios de puertas correderas

Cupboards with sliding doors
Armoires à portes coulissantes



Características:

Fabricado totalmente con acero inoxidable.
Laterales y trasera forrados de acero inoxidable.
Entrepaño intermedio.
Tiradores integrados en la puerta.
Puertas colgadas, con lo que se evitan depósitos de suciedad en carriles y entrepaños.

Characteristics:

Fully made of stainless steel.
Back and sides covered with stainless steel panels. Centered shelf.
The main advantage of our sliding doors tables consists on their hanging doors. They avoid dirtiness deposits in rails and shelves.
Furthermore the handles are integrated in the sheet.

Caractéristiques:

Fabriqué totalement en acier inoxydable.
Latérales et retour recouvertes en acier inoxydable . Tablette-rayon centre.
La principale avantage de nos tables à portes coulissantes c'est que ses portes sont suspendues pour éviter des dépôts de saleté dans les rails et dans les tablettes-rayons. En plus les poignées sont intégrées dans la plaque.



Vista de mesa y armario.
Table and wardrobe view.
Vue de table et armoire.

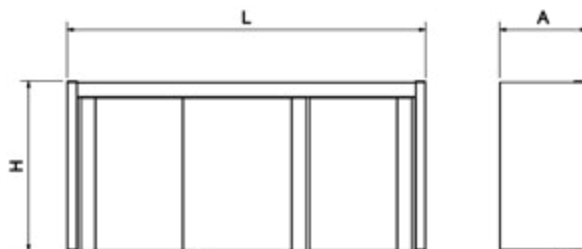

L	A	H		Kg		€
990	340	660	2	26,0	080806	886,00
1.390	340	660	3	36,0	080808	1.063,00
990	440	660	2	27,5	080802	974,00
1.390	440	660	3	36,0	080804	1.169,00

Armarios de puertas abatibles

Cupboards with hinged doors
Armoires à portes ouvrantes

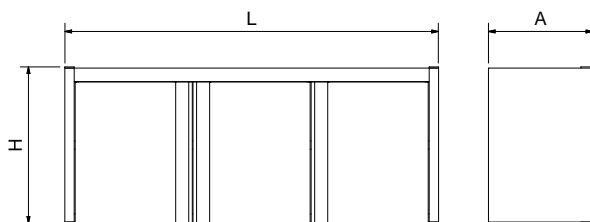

L	A	H		Kg		€
1.075	340	660	2	27	080810	780,00
1.575	340	660	3	42	080812	1.094,00
1.075	440	660	2	33	080814	1.003,00
1.575	440	660	3	48	080816	1.202,00

Armario de esquina derecha con puertas abatibles

Right corner cabinet with hinged doors
Armoire d'angle à droite avec portes ouvrantes

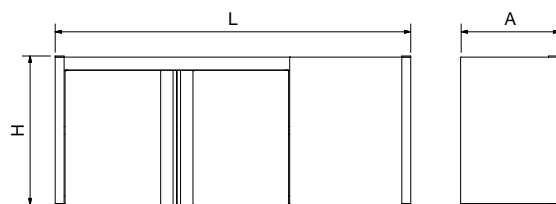

L	A	H		Kg		€
1.075	340	660	1	26	080820	911,00
1.575	340	660	2	41	080824	1.094,00
1.075	440	660	1	32	080828	1.003,00
1.575	440	660	2	47	080834	1.190,00

Armario de esquina izquierda con puertas abatibles

Left corner cabinet with hinged doors
Armoire d'angle à gauche avec portes ouvrantes

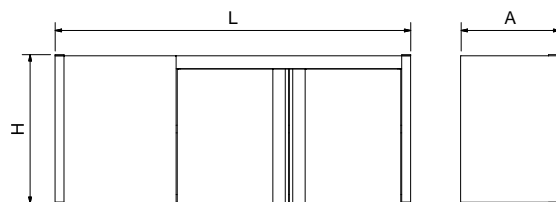

L	A	H		Kg		€
1.075	340	660	1	26	080818	911,00
1.575	340	660	2	41	080822	1.094,00
1.075	440	660	1	32	080826	1.003,00
1.575	440	660	2	47	080832	1.190,00

Armario para productos de limpieza

Wardrobe for cleaning products
Armoire pour produits d'entretien



Características:

Fabricado totalmente con acero inoxidable. Como dotación estándar lleva tres estantes en el lado derecho para la colocación de trapos, productos de limpieza, etc. Además, su diseño permite guardar cubos, recipientes grandes, escobas, fregonas, etc. Construido totalmente en acero inoxidable, acabado satinado, dispone de techo inclinado y 4 patas en altura de 115 mm para poder limpiar debajo de él. Estas patas están situadas de tal manera que salvan la curva sanitaria en la pared. Pies regulables. Ventilación mediante respiraderos. Pomo con posibilidad de acoplar candado. Ver página 351.



081612 265,00



Opción de kit de ozono acoplado.

Optional ozone kit, coupled
kit ozone accouplé



Set colgador sujeta-palos.

Handle-holder kit.
Kit porte-manches.



473



Opcional / Optional / Optionnel



Characteristics:

Fully made of stainless steel. As standard fitting it is equipped with three shelves on the right side for the storage of cloths, cleaning products, etc. Furthermore, it has been designed to lodge buckets, large containers, brooms, mops, etc. Wholly constructed of stainless steel with satin finish and sloping roof. Their feet are set back to bridge the wall sanitary curve and adjustable up to 115 mm, which will enable you clean underneath. Ventilation through hammered vents. Closing knob with the option of padlock. See page 351.

Caractéristiques:

Fabriqué totalement en acier inoxydable. Comme équipement standard il a trois étagères dans une des côtes pour la placement des chiffons, produit d'entretien, etc. En plus, sa dessine permet garder seaux, récipients grands, balais, balais-serpillières, etc. Construit totalement en acier inoxydable, avec finition satiné, ils ont toit penché et empiétements de 115 mm d haut pour qu on peut nettoyer dessous. Ces empiétements sont dessinées tellement qui sauvent la courbe sanitaire du mur et en même temps sont réglables. Aération par soupiraux emboutis et serrure. On peut placer un cadenas dans le bouton, voir page 351.

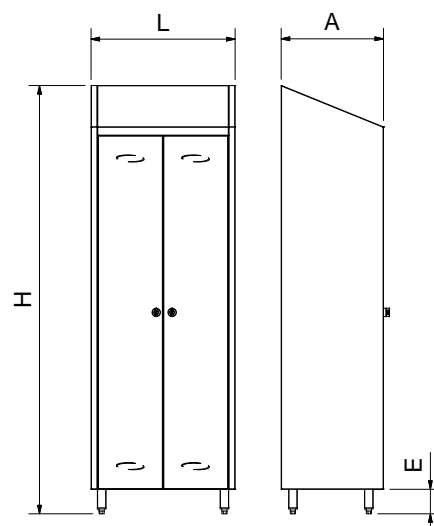

L	A	H	E		Kg		€
370	480	2.010	115	1	27	081412	780,00
680	480	2.010	115	2	45	081602	974,00



Consulten la posibilidad de acoplar un desinfectador-desodorizador por ozono en el armario.

Ask for the possibility of assembly a disinfectant-deodorant by ozone in the wardrobe
Demandez-nous sur la possibilité de accoupler un désinfectant-désodorisant à l'ozone dans l'armoire

Posibilidad de acoplar ruedas ver pág 496

Possibility of assembly wheels, see page 496
Possibilité d'accoupler rouelles, voir page 496

Armario estantería 2 puertas

2 doors shelving wardrobe

Armoire rayonnage de 2 portes



***HASTA 190 Kg**

Up to 190 kgs of load strength
Jusqu'à 190 kgs de résistance

Características:

Construido totalmente en acero inoxidable, acabado satinado, dispone de techo inclinado y 4 patas en altura de 115 mm para poder limpiar debajo de él. Estas patas están situadas de tal manera que salvan la curva sanitaria en la pared. Pies regulables. Ventilación mediante respiraderos embutidos. Pomo con posibilidad de colocar candado. Ver página 351.

Characteristics:

Wholly constructed of stainless steel with satin finish and sloping roof. Their feet are set back to bridge the wall sanitary curve and adjustable up to 115 mm, which will enable you clean underneath.

Ventilation through hammered vents. Closing knob with the option of padlock. See page 351.

Caractéristiques:

Construit totalement en acier inoxydable, avec finition satiné, ils ont toit penché et empiètements de 115 mm d'hauf pour qu'on peut nettoyer dessous. Ces empiètements sont dessinées tellement qui sauvent la courbe sanitaire du mur et en même temps sont réglables. Aération par soupiraux emboutis et serrure. On peut placer un cadenas dans le bouton, voir page 351.



081612 265,00



Opción de kit de ozono acoplado.
Optional ozone kit, coupled
kit ozone accouple



***HASTA 500 Kg**

Up to 500 kgs of load strength
Jusqu'à 500 kgs de résistance



El pomo admite la colocación de candado.
Handle-holder kit.
Kit porte-manches.

351

Opcional / Optional / Optionnel

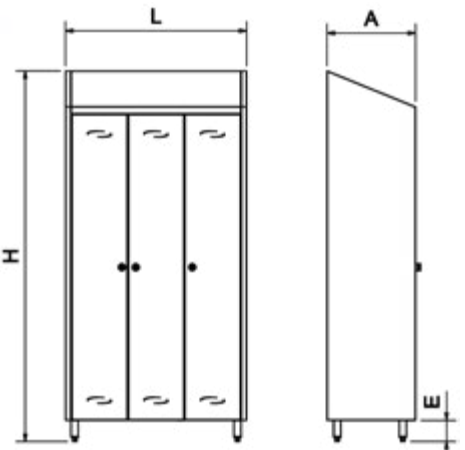

Posibilidad de acoplar ruedas ver pág 496
Possibility of assembly wheels, see page 496
Possibilité d'accoupler rouelles, voir page 496

L	A	H	E					€
680	480	2.010	115	2	190	55	081650	1.065,00
980	480	2.010	115	3	500	66	081652	1.540,00

Armario con cerradura y puertas transparentes para medicamentos y utensilios

Cabinet with lock and transparent doors for medicines and utensils

Armoire avec serrure et portes transparentes pour médicaments et ustensiles



Características:

Fabricado en acero inoxidable este armario dispone de puertas de amplia apertura dotadas de cerradura y paneles de PETG para permitir la visualización del interior.

Es ideal para el almacenaje seguro de material médico, instrumental o medicamentos.

Las patas incorporan tacos de plástico de alta resistencia ajustables en altura para adaptarse a cualquier estancia.

€ 59,00 351 Op

Cerradura de retorno de monedas
Coin operated lock
Serrure à monnaies



481405 € 8,50 351 Op

Cerradura maestra
Master lock
Serrure master



481402 € 4,10 351 Op

Llave maestra para cerraduras
Master key for locks
Clé passe-partout pour serrures



081612 € 265,00 Op

Opción de kit de ozono acoplado.
Optional ozone kit coupled
kit ozone accouple



€ 81,00 351 Op

Cerradura electrónica para taquilla
Electronic lock for lockers
Serrure électronique pour la porte vestiaire



Characteristics:

Made of stainless steel, this cabinet has wide-opening doors formed by a lock and PETG sheets to view the interior.

It is ideal for a safe storage of medical material, instruments or medicines.

Its legs are provided with height-adjustable high-resistance plastic blocks to adapt to any floor unevenness.

Caractéristiques:

Fabriquée en acier inoxydable, cette armoire est dotée de portes à large ouverture équipées d'une serrure et de panneaux en PETG pour permettre la visualisation de l'intérieur.

Il est idéal pour le stockage en toute sécurité de matériel médical, d'instruments ou de médicaments.

Les pieds intègrent des plots en plastique haute résistance réglables en hauteur pour s'adapter à n'importe quelle pièce.

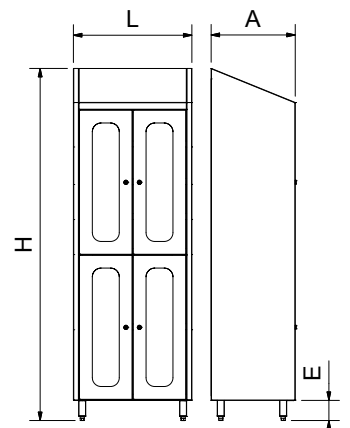

Posibilidad de acoplar ruedas ver pág 496
Possibility of assembly wheels, see page 496
Possibilité d'accoupler rouelles, voir page 496

L	A	H	E	Kg	Barcode	€
680	480	2.010	115	57	081620	1.100,00

Armario para equipos informáticos

Wardrobe for computer equipment
Cabinet pour matériel informatique



Características:

Construido totalmente en acero inoxidable, acabado satinado, dispone de techo inclinado y 4 patas en altura de 115 mm para poder limpiar debajo de él. Estas patas están situadas de tal manera que salvan la curva sanitaria en la pared. Pies regulables. Ventilación mediante respiraderos embutidos. Pomo con posibilidad de colocar candado. Ver página 351.

Characteristics:

Wholly constructed of stainless steel with satin finish and sloping roof. Their feet are set back to bridge the wall sanitary curve and adjustable up to 115 mm, which will enable you clean underneath. Ventilation through hammered vents. Closing knob with the option of padlock. See page 351.

Caractéristiques:

Construit totalement en acier inoxydable, avec finition satiné, ils ont toit penché et empiètements de 115 mm d' haut pour qu' on peut nettoyer dessous. Ces empiètements sont dessinées tellement qui sauvent la courbe sanitaire du mur et en même temps sont réglables. Aération par soupiraux emboutis et serrure. On peut placer un cadenas dans le bouton, voir page 351.



El pomo admite la colocación de candado.
Handle-holder kit.
Kit porte-manches.

351

Ⓞ Opcional / Optional / Optionnel



Posibilidad de acoplar ruedas ver pág 496
Possibility of assembly wheels, see page 496
Possibilité d' accoupler rouelles, voir page 496

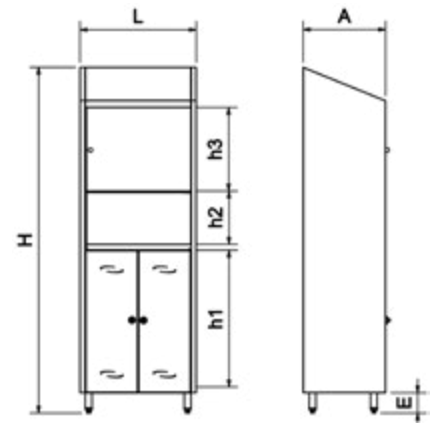

L	A	H	E	h1	h2	h3	Kg	Barcode	€
680	480	2.010	115	795	300	500	52	076402	1.314,00

Atril de acero inoxidable

Stainless steel desk
Pupitre en acier inoxydable



085480 200,00 494

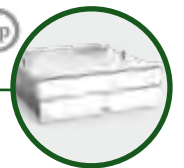

Cajón acoplado
Drawer coupled
Tiroir accouplé

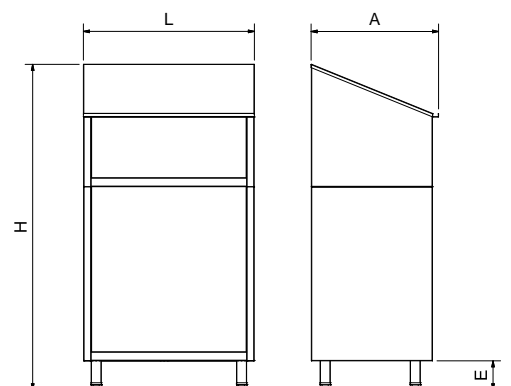

496



Ruedas
Wheels
Rouelles

L	A	H	E	Kg	Barcode	€
678	505	1.290	115	22	074428	841,00

Taquillas de 1, 2 y 3 puertas

1, 2 and 3 doors lockers

Armoire pour vestiaire de 1, 2 et 3 portes



Características:

Construida totalmente en acero inoxidable, acabado satinado. Dispone de techo inclinado y patas en altura de 115 mm para poder limpiar debajo de ella. Estas patas están situadas de manera que salvan la curva sanitaria en la pared. Pies regulables. Ventilación mediante respiraderos embutidos. Cerraduras independientes. Cada cuerpo lleva un entrepaño superior, otro en la base y un perchero.

Characteristics:

Wholly constructed of stainless steel with satin finish and sloping roof. Their feet are set back to bridge the wall sanitary curve and adjustable up to 115 mm, which will enable you clean underneath. Ventilation through hammered vents and individual locks. Every section has a lower shelf, an upper shelf and a clothes rack.

Caractéristiques:

Fait totalement en acier inox, finition satiné, ils ont le toit incliné, pieds en hauteur de 115 mm. Pour pouvoir nettoyer par dessous d'eux, aussi ces pieds sont situés pour qu'ils sauvent la curve sanitaire dans le mur, pieds réglables, ventilation par soupiraux encastrés, et fermeture indépendant. Chaque section a un évier supérieur et inférieur et un portemanteau.



€ 59,00 351

Cerradura de retorno de monedas
Coin operated lock
Serrure à monnaies



481405 8,50 351

Cerradura maestra
Master lock
Serrure master



481402 4,10 351

Llave maestra para cerraduras
Master key for locks
Clé passe-partout pour serrures



081612 265,00

Opción de kit de ozono acoplado.
Optional ozone kit coupled
kit ozone accouplé



€ 81,00 351

Cerradura electrónica para taquilla
Electronic lock for lockers
Serrure électronique pour la porte vestiaire

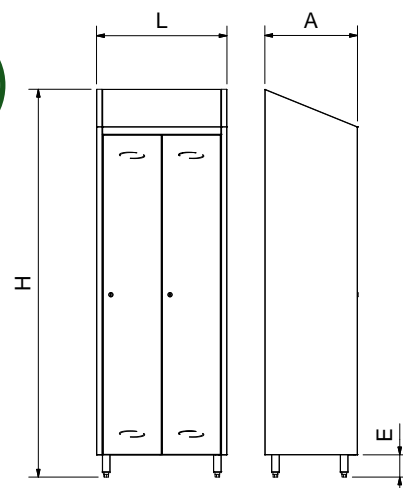

Contienen dos perchas inox por puerta.
Two inox hangers for each door included.
Deux cintres inox inclus par chaque porte.



Posibilidad de acoplar ruedas ver pág 497
Possibility of assembly wheels, see page 497
Possibilité d'accoupler rouelles, voir page 497

L	A	H	E		Kg	Barcode	€
370	480	2.010	115	1	27	081412	795,00
680	480	2.010	115	2	49	081406	1.158,00
985	480	2.010	115	3	62	081408	1.552,00



Consulten la posibilidad de acoplar un desinfectador-desodorizador por ozono en las taquillas.
Ask for the possibility of assembly a desinfectant-deodorizant by ozone in the locker.
Demandez-nous sur la possibilité de acoupler un désinfectant-désodorisant à l'ozone dans l'armoire.

Taquillas de 2, 4 y 6 puertas

2, 4 and 6 doors lockers

Armoire pour vestiaire de 2, 4 et 6 portes



Características:

Construida totalmente en acero inoxidable, acabado satinado. Dispone de techo inclinado y patas en altura de 115 mm para poder limpiar debajo de ella. Estas patas están situadas de manera que salvan la curva sanitaria en la pared. Pies regulables. Ventilación mediante respiraderos embutidos. Cerraduras independientes. Cada cuerpo lleva un entrepaño superior, otro en la base y un perchero.

Characteristics:

Wholly constructed of stainless steel with satin finish and sloping roof. Their feet are set back to bridge the wall sanitary curve and adjustable up to 115 mm, which will enable you clean underneath. Ventilation through hammered vents and individual locks. Every section has a lower shelf, an upper shelf and a clothes rack.

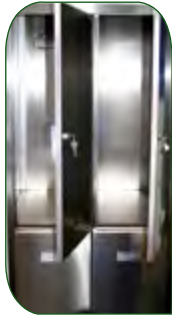

Caractéristiques:

Fait totalement en acier inox, finition satiné, ils ont le toit incliné, pieds en hauteur de 115 mm. Pour pouvoir nettoyer par dessous d'eux, aussi ces pieds sont situés pour qu'ils sauvent la curve sanitaire dans le mur, pieds réglables, ventilation par soupirlais encastrés, et fermeture indépendant. Chaque section a un évier supérieur et inférieur et un portemanteau.



€ 59,00 351 Op

Cerradura de retorno de monedas
Coin operated lock
Serrure à monnaies



481402 € 4,10 351 Op

Llave maestra para cerraduras
Master key for locks
Clé passe-partout pour serrures



081612 € 265,00 Op

Opción de kit de ozono acoplado.
Optional ozone kit, coupled
kit ozone accouplé

€ 81,00 351 Op

Cerradura electrónica para taquilla
Electronic lock for lockers
Serrure électronique pour la porte
vestiaire

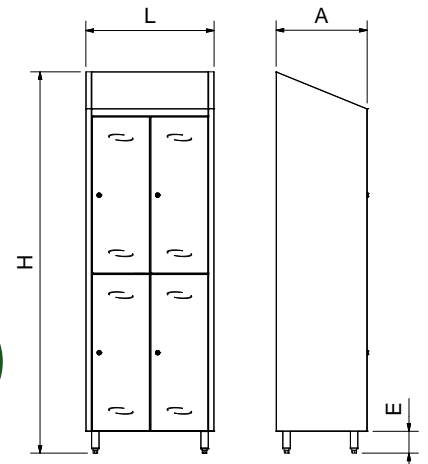

Contienen dos perchas
inox por puerta.
Two inox hangers for each
door included.
Deux cintres inox inclus par
chaque porte.



Posibilidad de acoplar ruedas ver pág 497
Possibility of assembly wheels, see page 497
Possibilité d'accoupler rouelles, voir page 497

L	A	H	E		Kg	Barcode	€
370	480	2.010	115	2	28	081410	899,00
680	480	2.010	115	4	50	081402	1.280,00
985	480	2.010	115	6	68	081404	1.787,00



Consulten la posibilidad de acoplar un desinfectador-desodorizador por ozono en las taquillas.
Ask for the possibility of assembly a disinfectant-deodorizant by ozone in the locker.
Demandez-nous sur la possibilité de accoupler un désinfectant-désodorisant à l'ozone dans l'armoire.

Percha industrial de acero inoxidable

Stainless steel industrial hanger
Cintre industrielle en acier inoxydable

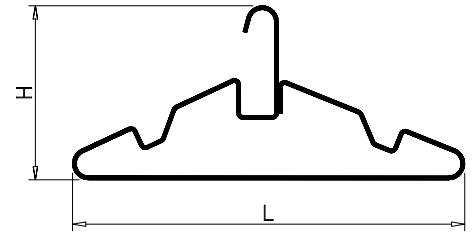

L	H	Gr	Barcode	€
420	190	120	081450	11,00

Separadores para taquillas

Dividers for lockers
Diviseur pour armoire vestiaire

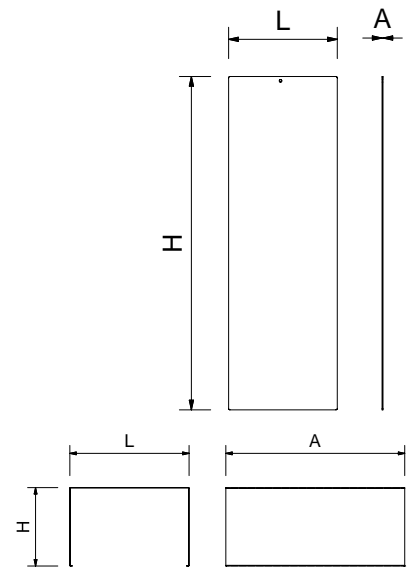

L	A	H	Kg	Barcode	€
450	3	1.180	0,80	081456	25,00
300	450	197	2,03	081458	33,00

Banco de vestuario en acero inoxidable y polietileno

Changing room bench in stainless steel and polyethylene
Banc de vestiaire en acier inoxydable et polyéthylène

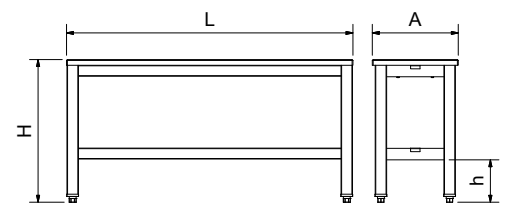













L	A	H	h	Kg	Barcode	€
1.000	300	500	150	10,00	084210	185,00
1.500	300	500	150	14,00	084212	223,00
2.000	300	500	150	18,00	084214	298,00



Repuestos y complementos

Spare part and complements

Rechange et compléments

		Gr		€
	Cerradura Lock Serrure	41	481404	5,50
	Cerradura maestra Master lock Serrure master	41	481405	8,50
	Llave maestra para cerraduras Master key for locks Clé passe-partout pour serrures	10	481402	4,10
	Juego de llaveros numerados del 1 al 6 Set of keyrings, numbered from 1 to 6 Ensemble de porte-cl-es numérotés de 1 à 6	30	481438	3,00
	Juego de placas numeradas del 1 al 6 Set of plates, numbered from 1 to 6 Ensemble de plaques numérotées de 1 à 6	20	481439	2,50
	Cerradura de retorno de monedas Coin operated lock Serrure à monnaies	790	481410	59,00
			481412	
	Montaje de la cerradura de retorno de monedas (no incluye cerradura) Assembly coin operated lock (lock not included in this price) Assembler serrure à monnaies (serrure n'inclus pas dans ce prix)		081452	34,00
	Cerradura con cadena para consigna de carros Locker with chain for left-shopping trolleys Serrure avec chaîne pour consigne pour caddies	850	481430	66,00
	Cerradura electrónica para taquilla Electronic lock for lockers Serrure électronique pour la porte vestiaire	584	481418	81,00
			481419	
	Montaje cerradura electrónica en puerta de taquilla (no incluye cerradura) Installation of electronic lock for lockers (lock not included) Montage serrure électronique sur porte de vestiaire (la serrure n'est pas incluse)		081454	32,00
	Pomo articulado Articulated handle Poignée articulée	80	481406	13,00
	Candado para pomo articulado Padlock for articulated handle Cadenas poignée articulée	105	481408	23,00
	Taco regulable Adjustable blocks Taquets réglables	45	409851	1,50
	Taco regulable altura especial Special height adjustable blocks Taquets réglables hayteur spéciale	115	409848	3,00
	Tirador para puerta abatible Handle for hinged door Poignet pour porte battante	80	474050	6,30





SEGURIDAD E HIGIENE

HEALTH AND CARE
SÉCURITÉ ET SANTÉ AU TRAVAIL

NOVEDADES

NEWS
NOUVEAUTÉS



358



361



361



364



368



378



390



400



403



404



407



408



410



412



412



423



424



424



Guante de cinco dedos ambidiestro en malla de acero inoxidable

Reversible five finger stainless-steel mesh gloves
Gants à cinq doigts réversibles en maille d'acier inoxydable



Guante fabricado en acero inoxidable. Antibacteriano para una higiene perfecta, reforzada gracias a su facilidad de limpieza. Mayor protección. Seguridad total, ya que carece de escotadura. Garantiza una protección total de la mano contra los cuchillos más afilados. Mayor confort de uso.

Talla Size Taille	XXS	XS	S	M	L
	≤72	73-78	79-83	84-88	≥89



Glove wholly made of stainless steel. Anti-bacteria glove for a perfect hygiene, reinforced thanks to its cleaning easiness. Higher protection. Total security, since it lacks low sleeve-line. It guarantees a total hand protection against the sharpest knives. Higher usage comfort.



Gant entièrement fabriqué en acier inoxydable. Gant anti-bactérienne pour une hygiène parfaite renforcée grâce à la facilité de sa nettoyage. Plus grande protection. Sécurité totale puisqu'il n'y a pas de échancrure. Il garantit une protection totale de la main contre les couteaux, même les plus aiguisés. Plus grande confort d'usage.

Talla Size Taille	Gr		€	Gr		€	Gr		€
XXS	130	448600	80,00	130	448610	115,00	200	448650	125,00
XS	140	448602	80,00	140	448612	115,00	235	448652	125,00
S	150	448604	80,00	150	448614	115,00	270	448654	125,00
M	170	448606	80,00	170	448616	115,00	305	448656	125,00
L	185	448608	80,00	185	448618	115,00	340	448658	125,00

Tensor para guantes malla

Tensor for stainless-steel mesh gloves
Tenseur des gants maille d'acier inoxydable



Talla Size Taille	Gr		Barcode	€
Única Universal Unique	800	100	448620	27,50

Delantal de protección en malla de acero inoxidable
 Stainless steel mesh protective apron
 Tablier de protection en maille d'acier inoxydable



DIN EN ISO 13998:2003
 DIN EN ISO 13998:2003
 DIN EN ISO 13998:2003

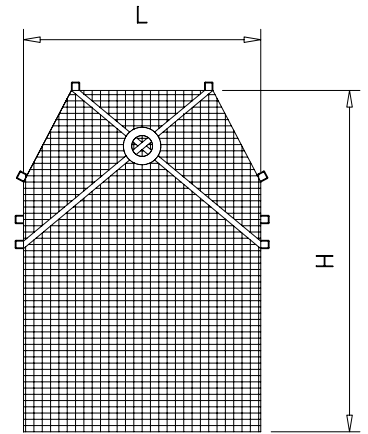

L	H	Kg	Barcode	€
600	800	1,15	448802	165,00

Delantal de escay
 Faux leather apron
 Tablier en skay

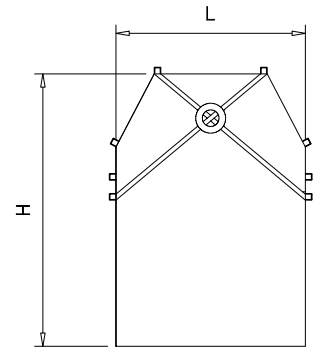

L	H	Gr	Barcode	€
700	1.100	600	448804	19,00

Guantes alimentarios anticorte
 Anti cut gloves for food use
 Gants alimentaires anti coupure



 **El precio es por pareja.**
 The pair is included in the price.
 Le paire est inclus dans de prix.

Tamaño Size Dimen- sion		Gr	Barcode	€
≤70	S	100	448670	9,00
71-80	M	110	448672	9,00
81-100	L	115	448674	9,00
≥101	XL	120	448676	9,00



Guantes para pescadero

Gloves for fishmongers
Gants pour poissonniers



Excelente protección en las industrias de pesca y viticultura.
Resistente a los cortes.
Látex.
Recubrimiento sobre soporte de algodón afelpado.
Longitud 300 mm.

Excellent protection for fishing and viticulture industry.
Cut-resistant.
Latex.
Coverage on cotton towel.
Length 300 mm.

Excellent protection pour les industries de la pêche et la viticulture.
Résistant aux coupures.
Latex.
Recouvrement sur coton pelucheux.
Longueur 300 mm.



El precio es por pareja.
The pair is included in the price.
Le paire est inclus dans de prix.

Talla
Size
Taille



Única Universal Unique	250	448668	13,00
------------------------------	-----	--------	--------------

Guantes anti-salpicaduras aceite hirviendo

Boiling oil anti splash gloves
Gant anti éclaboussures d'huile bouillant



Guante en piel con recubrimiento de kevlar aluminio en el dorso.

Glove in leather covered with Kevlar-aluminium in the back.

Gant en cuir avec recouvrement en Kevlar-aluminium dans le dos.



El precio es por pareja.
The pair is included in the price.
Le paire est inclus dans de prix.

Talla
Size
Taille



Única Universal Unique	400	448682	45,00
------------------------------	-----	--------	--------------

Guantes anticalóricos hasta 100°C

Anticaloric gloves up to 100°C
Gants anti calorique jusqu'à 100°C



Guante de rizo de algodón para la manipulación de piezas calientes durante un corto plazo, hasta 100°C. Puño de punto de algodón para garantizar un buen ajuste.

Gant en coton éponge pour la manipulation de pièces chaudes pendant une courte période, jusqu'à 100°C. Poignet en tricot de coton pour assurer un bon ajustement.

Cotton terry glove for handling hot stuffs for a short period, up to 100°C. Knitted cotton cuff to ensure a good fit.



El precio es por pareja.
The pair is included in the price.
Le paire est inclus dans de prix.

Talla
Size
Taille



Única Universal Unique	120	448678	11,00
------------------------------	-----	--------	--------------

Manoplas anticalóricas hasta 250°C

Anticaloric oven gloves up to 250°C
Moufles anti caloriques 250°C



Manopla para manipulación de piezas calientes hasta 250°C. Provista de forro de jersey y paravapor insertado entre el rizo y el jersey.

Oven glove for the handle of hot pieces up to 250°C. Provided with pull-over lining and anti-steam inserted between the boucles and the pull-over.

Moufle pour la manipulation des pièces chaudes jusqu'à 250°C. Pourvu de doublure de pull-over et para-vapeur inséré entre les boucles et le pull-over.



El precio es por pareja.
The pair is included in the price.
Le paire est inclus dans de prix.

Talla
Size
Taille



Única Universal Unique	440	448680	12,00
------------------------------	-----	--------	--------------

Manoplas anticálóricas hasta 500°C

Anticaloric oven gloves to 500°C
Moufles anti caloriques jusqu'à 500°C



El precio es por pareja.
The pair is included in the price.
Le paire est inclus dans de prix.

Talla Size Taille	Gr		€
-------------------------	----	--	---

Única Universal Unique	600	448681	90,00
------------------------------	-----	--------	--------------

Guantes para frío extremo en piel

Gloves for extreme cold in leather
Gants pour froid extrême en cuir



El precio es por pareja.
The pair is included in the price.
Le paire est inclus dans de prix.

Talla Size Taille	Gr		€
-------------------------	----	--	---

Única Universal Unique	380	448692	17,50
------------------------------	-----	--------	--------------

Guantes anticorte industrial

Anti-cut industrial gloves
Gants anticoupure industriel



El precio es por pareja.
The pair is included in the price.
Le paire est inclus dans de prix.

Talla Size Taille	Gr		€
-------------------------	----	--	---

Única Universal Unique	40	448684	7,00
------------------------------	----	--------	-------------



Guantes de piel industrial
Industrial leather gloves
Gants industriel en cuir



El precio es por pareja.
The pair is included in the price.
Le paire est inclus dans de prix.

Talla
Size
Taille



Única
Universal
Unique

120	448686	4,00
-----	--------	-------------

Guantes de protección química
Chemical protective gloves
Gants de protection chimique



El precio es por pareja.
The pair is included in the price.
Le paire est inclus dans de prix.

Talla
Size
Taille



Única
Universal
Unique

116	448688	3,75
-----	--------	-------------

Guantes de nitrilo para uso alimentario
Nitrile gloves for food use
Gants en nitrile pour usage alimentaire



El precio es por pareja.
The pair is included in the price.
Le paire est inclus dans de prix.

L



380	195	448666	7,50
-----	-----	--------	-------------

Guantes de nitrilo escamados talla L (caja 50 ud.)
Fish-scale grip nitrile gloves – L size (pack of 50 pairs)
Gants nitrile avec écailles taille L (carton 50 unités)



500	448664	24,00
-----	--------	--------------

Gafas antiproyecciones

Protective glasses
Lunettes de protection



Gafa panorámica unilente de policarbonato, compatible con gafas graduadas.

Single lens polycarbonate goggle compatible with prescription glasses.

Lunettes-masques en polycarbonate à une seule verre, compatibles avec des lunettes de vue.

Gr		€
150	448830	1,80

Pantalla antiproyecciones

Protective mask
Masque de protection



Gr		€
180	448834	7,00

Protector auditivo

Hearing Protector
Protecteur de l'oreille



Protector auditivo ergonómico de alto confort.
Atenuación alta. SNR: 30dB.
Almohadilla en el arnés.

Ergonomic hearing protector with superior comfort
High noise attenuation, SNR 30dB
Padded headband.

Protection auditive ergonomique avec un confort supérieur
Atténuation du bruit, SNR 30dB
Arceau rembourré.

L	A	H	Gr		€
210	80	190	150	448832	7,50

Botas de agua PVC/Nitrilo

Waterproof boots in PVC/Nitrile
Bottes pluie en PVC / Nitrile



Talla Size Taille	Gr		€
38	1.568	448850	17,00
39	1.602	448852	17,00
40	1.676	448854	17,00
41	1.786	448856	17,00
42	1.852	448858	17,00
43	2.002	448860	17,00
44	2.098	448862	17,00

Termómetro digital básico

Basic digital thermometer
Thermomètre digital basic



Sonda de acero inoxidable de 125 mm. ø 3.5 mm.
Rango de -50°C a 200°C / Resolución 0,1°C

Stainless steel 125 mm. ø 3.5 mm probe.
Measurement from -50°C to 200°C / Resolution 0.1°C

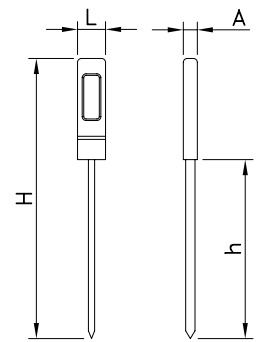

Sonde de 125 mm. ø 3.5 mm. en acier inoxydable.
Mesurage de -50°C à 200°C / Résolution 0,1°C

L	A	H	h	Gr	Barcode	€
20	20	195	115	24,0	480804	6,00

Termómetro digital resistente al agua

Water-proof digital thermometer
Thermomètre digital résistant à l'eau



Sonda rotativa de 127 mm.
Resistente al agua IP67.
Rango de -50°C a 300°C.
Resolución 0,1°C.

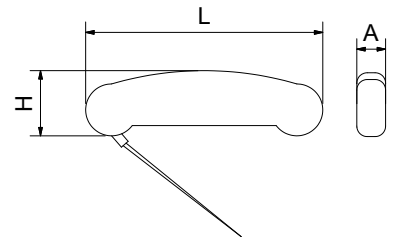

Rotating probe of 127 mm. Water-proof IP67.
Measuring range: -50°C a 300°C.
Resolution 0,1°C.

Sonde rotative 127 MM. Étanche IP67.
Mesurage: -50°C a 300°C. Résolution 0,1°C.

L	A	H	Gr	Barcode	€
180	18	45	36,0	480814	23,00

Termómetro digital con sonda para frigorífico-congelador

Digital probe thermometer for fridge and freezer
Thermomètre digital à sonde pour réfrigérateur et congélateur



Rango de -50°C a 70°C / Resolución 0,1°C
Cable 1.200 mm.
Con alarma programable.

Measurement from -50°C to 70°C /
Resolution 0.1°C
Cable length: 1.200 mm
Adjustable alarm

Mesurage de -50°C à 70°C / Résolution 0,1°C
Longueur du câble: 1.200 mm
Alarme réglable

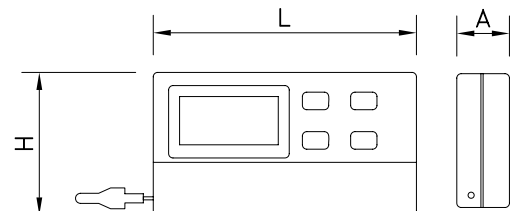

L	A	H	Gr	Barcode	€
60	12	30	80	480806	15,00

Termómetro digital de acero inoxidable para horno

Stainless steel digital thermometer for oven
Thermomètre digital en acier inoxydable spécial four



Rango de -50°C a 300°C
Resolución: 0,1°C
Cronómetro 99' 59"
Sonda de acero inoxidable de 110 mm
Cable de acero inoxidable 1,2 metro
Alarma
Imán

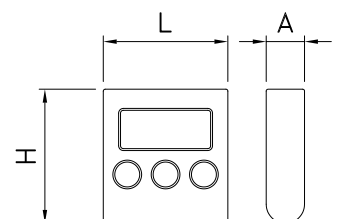

Mesurage de -50°C à 300°C
Résolution 0,1°C
Chronomètre 99' 59"
Sonde inox 110 mm
Câble inox 1,2 mètre
Alarme
Dos aimanté

Measurement from -50°C to 300°C
Resolution 0.1°C
Stopwatch 99' 59"
Stainless steel probe 110 mm
Stainless steel cable 1,2 meter
Alarm
With magnet

L	A	H	Gr	Barcode	€
65	16	70	80,0	480842	15,00

Termómetro barbacoa bluetooth con 6 sondas

Bluetooth barbecue thermometer with 6 probes
Thermomètre barbecue Bluetooth avec 6 sondes



Rango de 50°C a 300°C / Resolución 1°C
Cable 1000 mm.

Measurement from 50°C to 300°C /
Resolution 1°C
Cable length: 1000 mm.

Mesurage de 50°C à 300°C /
Résolution 1°C
Longueur du câble: 1000 mm.

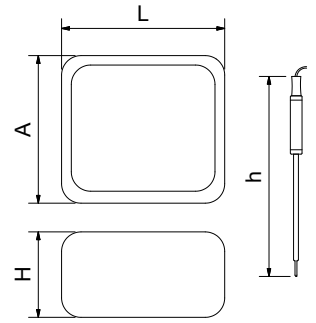

L	A	H	Gr	Barcode	€
84	76	44	475	480816	88,00

Termómetro para horno con selección de programas wireless

Oven thermometer with wireless program selector
Thermomètre de four avec sélection de programme sans fil



Rango de 50°C a 300°C / Resolución 1°C
Cable 1000 mm.

Measurement from 50°C to 300°C /
Resolution 1°C
Cable length: 1000 mm.

Mesurage de 50°C à 300°C / Résolution 1°C
Longueur du câble: 1000 mm.

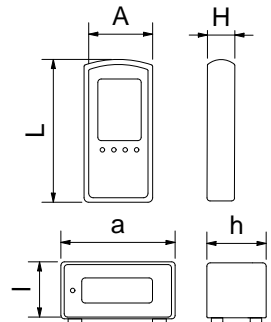

L	A	H	Gr	Barcode	€
80	50	130	220	480808	53,00

Termómetro electrónico de sonda

Electronic probe thermometer
Thermomètre à sonde électronique



Sonda de acero inoxidable de 127 mm.
Rango de -45°C a 200°C / Resolución 0,05°C
Precisión +/- 1°C
Funcionamiento a 1 Batería AA de 1.5

Stainless steel 127 mm. probe.
Measurement from -45°C to 200°C / Resolution 0,05°C
Deflection +/- 1°C
Operation at 1 battery AA 1.5

Sonde de 127 mm. en acier inoxydable.
Mesurage de -45°C à 200°C / Résolution 0,05°C
Déviation +/- 1°C
Opération à 1 pile AA 1.5

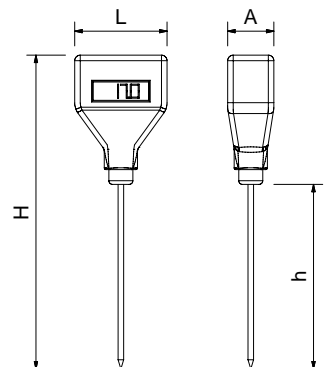

L	A	H	h	Gr	Barcode	€
32	29	143	127	25,0	480802	16,00

Termómetro digital pistola de infrarrojos

Digital infrared thermometer
Thermomètre digital à infrarouge



Rango de -50°C a 280°C / Resolución 0.1°C
Luz en pantalla.

Range from -50°C to 280°C / Resolution 0.1°C
Screen with backlight. Adjustable alarm

Gamme de -50°C à 280°C / Résolution 0.1°C
Ecran avec rétro-éclairage.

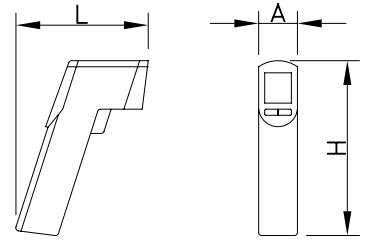

L	A	H	Gr	Barcode	€
75	30	160	220,0	480812	23,00

Termómetro para barbacoa

Barbecue thermometer
Thermomètre pour barbecue



Resolución 0.1°C

Resolution 0.1°C

Resolution 0.1°C

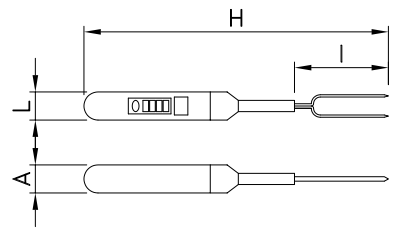

L	A	H	I	Gr	Barcode	€
40	35	430	150	216	480818	22,50

Termómetro compacto

Compact thermometer
Thermomètre compact



Sonda de acero inoxidable de 80 mm. ø 3,5 mm.
Rango de -50°C +200°C / Resolución 0.1°C

Stainless steel 80 mm. ø 3,5 mm. probe.
Measurement from -50°C to +200°C /
Resolution 0.1°C

Sonde de 80 mm. ø 3,5 mm. en
acier inoxydable.
Mesurage de -50°C à 200°C /
Resolution 0.1°C

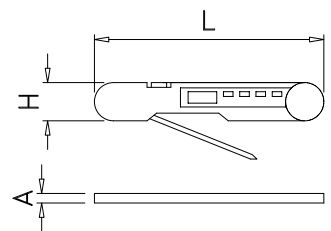

L	A	H	Gr	Barcode	€
140	10	28	80	480821	25,00

Termómetro con sonda para atornillar

Screw probe thermometer
Thermomètre avec sonde pour filetage



Sonda de acero inoxidable de 105 mm. ø 8 mm.
Rango de -50°C +200°C / Resolución 0.1°

Stainless steel 105 mm. ø 8 mm. probe.
Measurement from -50°C to +200°C / Resolution 0.1°

Sonde de 105 mm. ø 8 mm. en acier inoxydable.
Mesurage de -50°C à +200°C / Resolution 0.1°

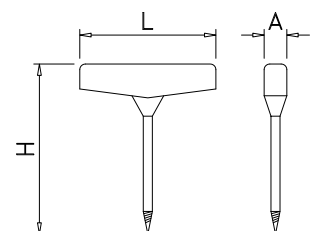

L	A	H	Gr	Barcode	€
120	20	150	145	480830	47,00

Termómetro pistola con sonda

Pistol thermometer with probe
Thermomètre en forme de pistolet avec sonde



Sonda de acero inoxidable de 80 mm. ø 3,5 mm.
Rango de -50°C +200°C / Resolución 0.1°C

Sonde de 80 mm. ø 3,5 mm. en acier inoxydable.
Mesurage de -50°C à +200°C / Résolution 0.1°C

Stainless steel 80 mm. ø 3,5 mm. probe.
Measurement from -50°C to +200°C / Resolution 0.1°C

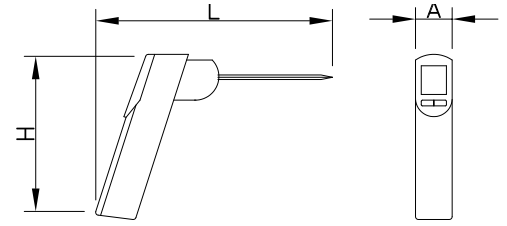

L	A	H	Gr	Barcode	€
75	30	160	250	480832	57,00

Termómetro con sonda larga

Long probe thermometer
Thermomètre sonde longue



Sonda de acero inoxidable de 200 mm. ø3,5 mm.
Rango de -50°C a +200°C / Resolución 0.1°C
Cable 1000 mm.

Stainless steel 200 mm. ø 3,5 mm. probe.
Measurement from -50°C to +200°C / Resolution 0.1°C
Cable length: 1000 mm

Sonde de 200 mm. ø 3,5 mm. en acier inoxydable.
Mesurage de -50°C à +200°C / Résolution 0.1°C
Longueur du câble: 1000 mm

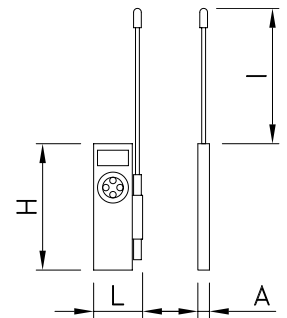

L	I	A	H	Gr	Barcode	€
60	200	18	180	120	480834	20,00

Registrador de temperatura y humedad

Temperature and humidity recorder
Enregistreur de température et humidité



Características:

Resolución: 0.1°C.
Precisión: +-1°C.
Resolución humedad: De 1% en 1%.
Sensor interno + Sonda externa.
Sonda: 50 mm ø3mm.
Capacidad de grabación 8000 puntos.
Intervalo de grabación de 10 sg a 24 horas.
Cable 1 metro.
Impermeable IP65.
Conexión USB.
Alarma.
1 pila CR2450-3V.
De -40 a +85°C con la sonda.
De -30 a +60°C sin la sonda.
Registro de humedad de 0 - 99%.

Characteristics:

Resolution: 0.1°C.
Accuracy: +-1°C.
Humidity resolution: every 1%.
Indoor sensor + outdoor probe.
Probe: 50 mm ø3mm.
Can store up to 8.000 measurements.
Recording intervals can be set from 10 seconds to 24 hours.
100 cm cable.
Waterproof IP65.
USB connection.
Alarm.
1 battery CR2450-3V included.
Range: -30°C to 85°C with probe.
-30°C to 60°C without probe.
Humidity record: 0 - 99%.

Caractéristiques:

Résolution: 0.1°C.
Précision: +-1°C.
Résolution humidité : de 1% en 1%
Capteur interne + la Sonde externe.
Sonde : 50 mms ø3mm.
Capacité d'enregistrement de 8000 points.
Intervalle d'enregistrement de 10 sg à 24 heures.
Câble de 1 mètre.
Imperméable IP65.
Connexion USB.
Alarme.
1 pile CR2450-3V.
De -40 à +85°C avec la sonde.
De -30 à +60°C sans la sonde.
Registre d'humidité de 0-99%

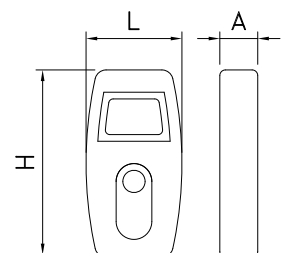

L	A	H	Gr	Barcode	€
43	17	84	102	480852	89,00

Termómetro para lavavajillas
Dishwasher thermometer
Thermomètre pour lave-vaisselle

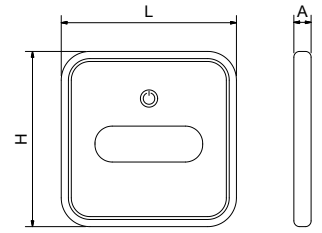

L	A	H	Gr	Barcode	€
122	122	12	130	480864	71,00

Temporizador digital de cocina
Kitchen digital timer
Minuterie de cuisine digital

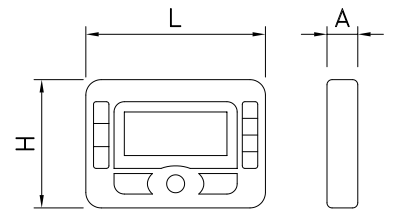

L	A	H	Gr	Barcode	€
72	20	64	80	480836	9,00

Cronómetro de cocina
Kitchen timer
Minuterie de cuisine

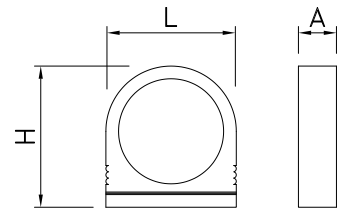

L	A	H	Gr	Barcode	€
60	20	70	120	480838	4,60

Medidor de compuestos polares / calidad del aceite de fritura
Meter for frying oil quality / polar compounds
Mesureur de composés polaires / Qualité de l'huile de friture

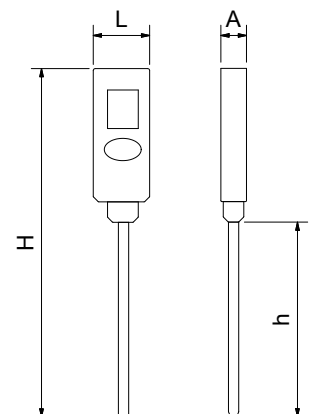

L	A	H	h	Gr	Barcode	€
50	25	340	190	185	480854	450,00

Novedad
NEW
Product

Medidor de PH
PH check
Check pour PH



Characteristics:
PH pocket meter
Waterproof with replaceable electrode
Resolution: 0.1 pH
Accuracy: +/- 0.1 pH / +/- 1 digit
Auto-calibration: pH 7.00

Características:
Medidor de PH de bolsillo
Impermeable con electrodo intercambiable
Resolución: 0.1 pH
Precisión: +/- 0.1 pH / +/- 1 digit
Auto-calibración: pH 7.00

Caractéristiques:
PH-mètre de poche
Étanche avec électrode remplaçable
Résolution: 0.1 pH
Précision: 0.1 pH +/- / +/- 1 chiffre
Auto-calibration: pH 7.00

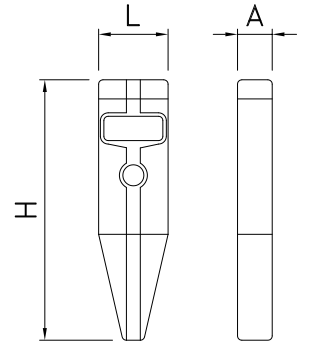

L	A	H	Gr	Barcode	€
40	20	150	350	480828	89,00

Termómetro infrarrojo para personas
Infrared thermometer for use in people
Thermomètre infrarouge pour personnes

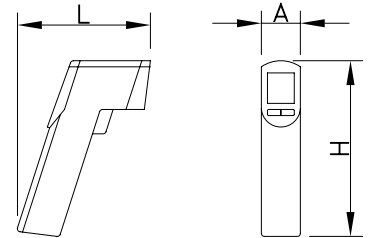

L	A	H	Gr	Barcode	€
120	60	190	210	480856	21,00

Termómetro infrarrojo mural
Wall-mounted infrared thermometer
Thermomètre infrarouge mural

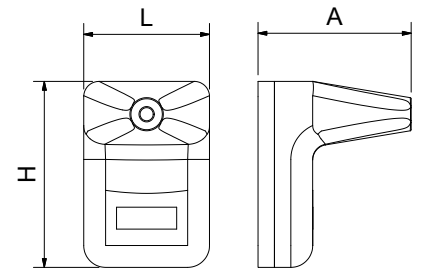

L	A	H	Gr	Barcode	€
115	140	170	350	480858	45,00

Panel medidor de CO2 monitor de calidad del aire mural / sobremesa
Wall / desktop air quality monitor with CO2 detector
Panneau de mesure de CO2 pour moniteur de qualité de l'air mural / sur table

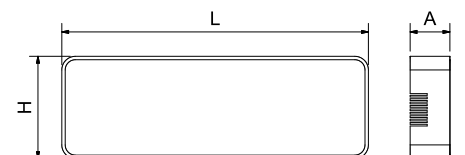

L	A	H	Gr	Barcode	€
270	35	90	270	480862	124,00

Monitor de calidad del aire detector de CO2

Air quality monitor with CO2 detector

Moniteur de qualité de l'air détecteur de CO2

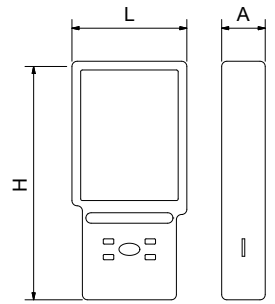

L	A	H	Gr	Barcode	€
66	25	137	112	480860	58,00

Purificador de aire con filtro HEPA y lámpara UV hasta 60 m2

Air purifier with HEPA filter and UV lamp up to 60 m2

Purificateur d'air avec filtre HEPA et lampe UV jusqu'à 60 m2

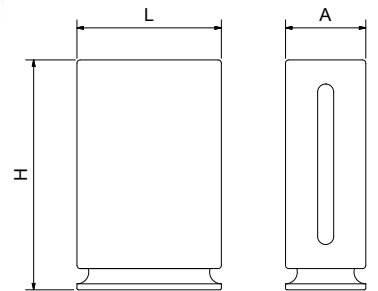

L	A	H	Tensión Voltage Tension	Frecuencia Frequency Frecuence	Potencia Power Puissance	Kg	Barcode	€
360	205	573	230 V	50/60 Hz	35 W	4,50	448540	145,00

Repuestos para purificador de aire

Spare parts for air purifier

Pièces de rechange pour purificateur d'air



Filtro repuesto HEPA 13
HEPA 13 replacement filter
Filtre HEPA 13 de remplacement

448551 **77,00**



Lampara UV-C 2 pines 10 W.
2 pin lamp UV-C 10W.
Lampara UV-C 2 pins 10W.

448552 **20,00**

Generadores de ozono inyectado para interior de cámaras frigoríficas

Injected Ozone generators for the interior of cold chambers and for indoor atmospheres

Générateurs d'ozone injecté pour l'intérieur de chambres frigorifiques et pour atmosphères d'intérieur



¿Qué es el Ozono?

El ozono (O3) es uno de los componentes naturales del aire y su función es la de regular la temperatura y el grado de humedad del ambiente.

Los objetivos de la ozonización son cuatro:

Asepsia de los locales de manipulación, conservación y distribución de alimentos.

Disminución de pérdidas de peso de los alimentos durante su almacenaje.

Desodorización total de los locales y supresión de olores de unos alimentos a otros.

Posibilidad de aumentar el tiempo de almacenaje de los alimentos en un estado óptimo.

En lo que se refiere al primer objetivo, el ozono asegura la destrucción de los numerosos microorganismos que se encuentran en la superficie de los productos alimenticios al introducirlos en las cámaras frigoríficas. Manteniendo la cámara en las condiciones más asépticas posibles se dificulta el contagio de una pieza a otra.

Respecto a las mermas de peso, éstas se deben a las pérdidas de agua de los tejidos animales y vegetales. El ozono evitará en gran parte este proceso.

La desodorización se consigue gracias a la capacidad del ozono para oxidar

la materia orgánica causante de los olores desagradables.

El último objetivo es fácilmente explicable por el amplio espectro antimicrobiano del ozono, capaz de destruir las bacterias, virus, hongos e incluso esporas.

Para más información ponemos a su disposición informes realizados en cámaras frigoríficas destinadas a la conservación de carnes, frutas y pescados.

Tipo de cámara Type of chamber Type de chambre	Coefficiente Coefficient Coefficient
Carnes Meat Viandes	1,5
Pescados Fish Poissons	1,7
Frutas y verduras Fruits & Vegetables Fruits et légumes	1,6
Mixtas Mixed Mixtes	1,5

What is Ozone?

Ozone (O3) is one of the natural components of the air and its function is to regulate the temperature and the degree of humidity in the atmosphere.

Properties:

The use of ozone in cold-storage chambers is, at present, the only system of environmental decontamination that is radically and definitively effective.

It disinfects, absorbs odours and sterilizes.

It destroys fungi, bacteria and viruses - even the most resistant microbes - and thus losses are significantly reduced in the ozonized chambers. It also prevents the mixing of odours.

For further information, we can provide you with reports produced on refrigerated chambers used for the storage of meat, fruit and fish.

Qu'est-ce que l'ozone ?

L'ozone (O3) est l'un des composants naturels de l'air et sa fonction consiste à régler la température et le degré d'humidité de l'atmosphère.

Propriétés:

L'apport d'ozone aux chambres frigorifiques est actuellement le seul système de décontamination environnementale qui agit de façon radicale et définitive.

Il désinfecte, désodorise et stérilise.

Il détruit les champignons, les bactéries et même les microbes les plus résistants, aussi les pertes dans les chambres frigorifiques sont-elles considérablement réduites. Il évite le mélange d'odeurs.

Pour plus d'informations, nous mettons à votre disposition des rapports effectués dans des chambres frigorifiques destinées à la conservation de viandes, de fruits et de poissons.

How to select the ideal equipment ?

Multiply the volume (in m3) of the chamber to be ozonized by the coefficient corresponding to the type in question. We must then choose the equipment whose production in mg/h most closely relates to that figure.

E.g. In a mixed chamber of 4 x 3 x 3 m, the calculation would be as follows:

$$4 \times 3 \times 3 = 36 \text{ m}^3$$

$$36 \times 1,5 = 54$$

In this case, the required model would be the H-20.

Comment choisir l'équipement idéal ?

Multiplier le volume (en m³) de la chambre à ozoniser par le coefficient correspondant au type de chambre. L'on doit choisir l'équipement dont la production de mg/h s'adaptera le mieux. Par ex., dans une chambre mixte de 4 x 3 x 3 m, le calcul sera le suivant:

$$4 \times 3 \times 3 = 36 \text{ m}^3$$

$$36 \times 1,5 = 54$$

Dans ce cas, le modèle nécessaire serait le H-20.

¿Cómo elegir el equipo idóneo?

Multiplicar el volumen (en m³) de la cámara a ozonizar por el coeficiente correspondiente al tipo de cámara. Debemos escoger el equipo cuya producción de mg/h más se ajuste. p. ej. En una cámara mixta de 4 x 3 x 3 m el cálculo sería el siguiente:



$$4 \times 3 \times 3 = 36 \text{ m}^3$$

$$36 \times 1,5 = 54$$

En este caso, el modelo necesario sería el H-20.

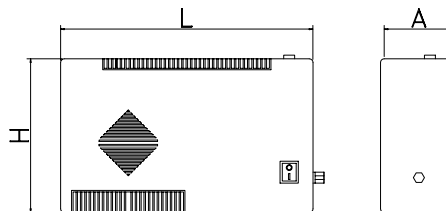
Uso Wearing Usage	Coefficiente Coefficient Coefficient
Olor penetrante Penetrating smell Odeur pénétrant	0,8
Olor intenso Intense smell Odeur intense	0,7
Olor moderado Moderated smell Odeur modéré	0,6



Modelo Type Modèle	L	A	H	Producción Production Production mg/h	Tensión Voltage Tension	Frecuencia Frequency Fréquence	Potencia Power Puissance	Barcode	€	
	H-10	355	110	220	30	220 V	50 Hz	15 W	485202	540,00
	H-20	355	110	220	60	220 V	50 Hz	18 W	485204	570,00
	H-30	355	110	220	90	220 V	50 Hz	19 W	485206	600,00
	H-50	400	170	450	500	220 V	50 Hz	55 W	485208	2.600,00
	H-100	400	170	450	1.000	220 V	50 Hz	70 W	485212	3.200,00

Cañón de ozono portátil 7.000 mg/h

Portable ozone cannon 7.000 mg/h
Portable ozone generator 7.000 mg/h

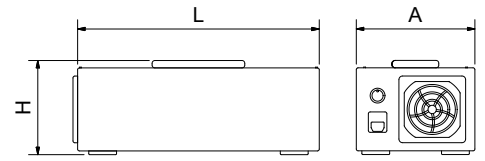

L	A	H	Tensión Voltage Tension	Frecuencia Frequency Frecuence	Potencia Power Puissance	Producción Production Production mg/h	Kg	Barcode	€
370	165	250	230 V	50/60 Hz	80 W	7.000	3,00	448424	450,00

Ozonizador de agua

Ozone generator for water with tap
Générateur d'ozone pour l'eau avec robinet



Características:

Gracias a este equipo generador de ozono se consigue agua ozonizada, ideal para realizar una colada más eficiente que el jabón y, además, sin añadir contaminantes al agua ni al entorno. Limpiar y desinfectar con agua ozonizada es una solución altamente higiénica.

Además de su uso principal, incorpora un grifo para el llenado de utensilios de lavado para suelos, superficies, etc. Incluso puede utilizarse para enjuagar frutas y verduras.

Este agua deberá utilizarse durante los primeros 15/20 minutos, pues posteriormente perderá sus propiedades desinfectantes.

*El agua tratada por este equipo es únicamente para el lavado y desinfección. No para consumo.

*Las propiedades del ozono sólo son efectivas en agua fría.



Characteristics:

This ozone generator device will provide you ozonated water. Cleaning and disinfecting with ozonated water is a highly hygienic solution. It is supplied with a tap for filling washing containers.

*The water treated by this device is only intended for washing and disinfection. Not for consumption.

*Ozone properties are only effective in cold water.

Caractéristiques:

Grâce à cet équipement générateur d'ozone, on obtient de l'eau ozonée. Le nettoyage et la désinfection à l'eau ozonée est une solution hautement hygiénique.

Il intègre un robinet pour le remplissage des ustensiles de lavage.

*L'eau traitée par cet équipement est uniquement destinée au lavage et à la désinfection. Pas pour la consommation.

*Les propriétés de l'ozone ne sont efficaces que dans l'eau froide.

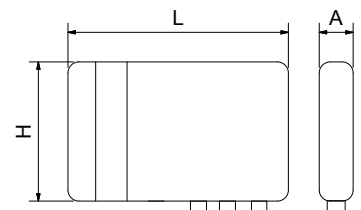

L	A	H	Tensión Voltage Tension	Frecuencia Frequency Frecuence	Potencia Power Puissance	Flow Débit	Kg	Barcode	€
450	78	250	100-240V	50Hz	240 W	2,5-5 l/min	4,50	448410	386,00

Cortina de ozono especial pescaderías

Ozone curtain, especially for fishmongers
Rideau d'ozone spécial pour poissonneries



Características:

Reducción máxima del fuerte olor que desprende la sección de pescadería.
Mantiene durante más tiempo el aspecto de los pescados expuestos sobre el mostrador.
Reduce la carga microbiana presente en el pescado.
Fácil instalación.

Characteristics:

Maximum reduction of odors that are generated in fishmongers.
It keeps the good appearance of fishes exhibited in displays.
It eliminates the microbes present in fishes.
Easy to install.

Caractéristiques:

Réduction maximale des odeurs qui sont générés dans les poissonneries.
Il maintient la bonne apparence des poissons exposés dans les écrans.
Il élimine les microbes présents dans les poissons.
Facile à installer.

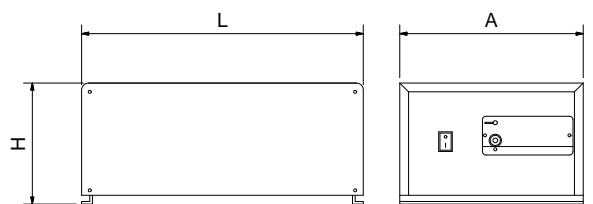
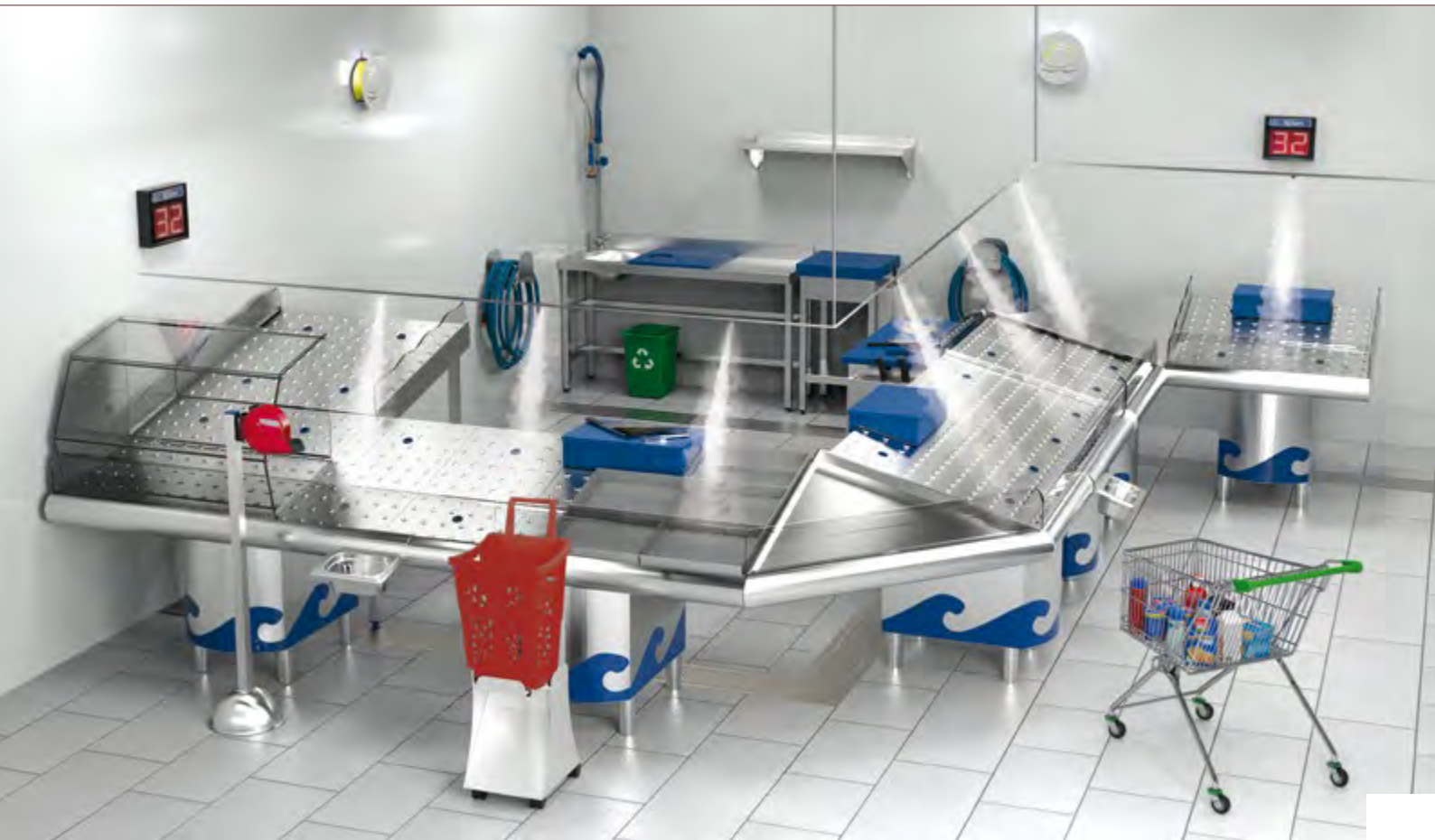

L	A	H	↔	Tensión Voltage Tension	Frecuencia Frequency Fréquence	Potencia Power Puissance	Kg	Barcode	€
380	200	160	0-10 mts.	220 V	50 Hz	80 W	5,00	448430	2.443,00

Esterilizador de cuchillos mediante agua caliente para adosar

Hot water knifeholder disinfectant for mounting
Porte-couteaux désinfecteur à l'eau chaude pour adosser



Características:

Entrada de agua y desagüe con llave de corte, rebosadero, resistencia eléctrica protegida con termostato. Capacidad: 24 cuchillos.

Characteristics:

Water inlet and drain with stopcock, overflow, electrical resistance protected with thermostat. Capacity: 24 knives.

Caractéristiques:

Entrée d'eau et robinet d'écoulement, déversoir, résistance électrique avec thermostat. Capacité: 24 couteaux.



Cuchillero con alojamiento especial para tijeras y chairas.

Knife-holder with special lodging for scissors and sharpeners.
Porte-couteaux avec logement spécial pour ciseaux et fusils à affûter.



Repuestos.
Spare parts.
Pièces de rechange.

375

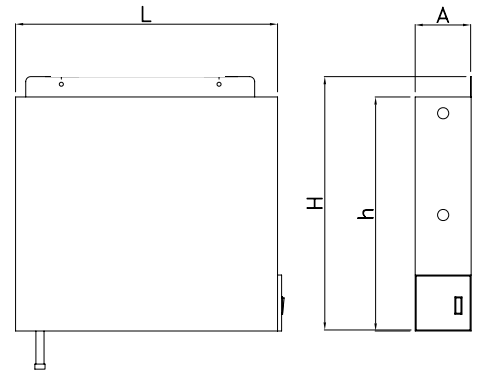

L	A	H	h	Tensión Voltage Tension	Frecuencia Frequency Fréquence	Potencia Power Puissance	Kg	Barcode	€
515	105	490	460	220 V	50 Hz	1.000 W	10,65	040402	693,00

Esterilizador de cuchillos mediante ozono para adosar

Ozone knifeholder disinfectant for mounting
Porte-couteaux désinfecteur à l'ozone pour adosser



Características:

Interruptor luminoso On/Off. Toma de tierra.

Characteristics:

On/Off lighting switch. Ground.

Caractéristiques:

Interrupteur lumineux On/Off. Prise de terre.

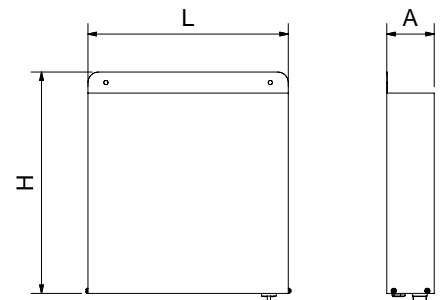

Capacidad: 20 cuchillos
Capacity: 20 Knives
Capacité: 20 couteaux



Repuestos.
Spare parts.
Pièces de rechange.

375

L	A	H	Tensión Voltage Tension	Frecuencia Frequency Fréquence	Potencia Power Puissance	Kg	Barcode	€
380	90	420	220 V	50 Hz	6 W	5	040472	227,00

Armarios esterilizadores de cuchillos rayos U.V.

U.V. knives disinfectant cabinets

Armoires désinfectants de couteaux U.V.



Principios de funcionamiento:

La lámpara emite rayos ultravioletas germicidas que transforman el oxígeno en ozono, destruyendo así las bacterias mediante la hiper-oxidación.

No es preciso demostrar ya el efecto de la radiación U.V.C. Es totalmente bactericida, antiviral, germicida, etc.

Los armarios generadores de U.V.C. aseguran así una excelente descontaminación de los utensilios situados en los cuchilleros.

Estos armarios, en conformidad con las normas de higiene, encuentran su aplicación en todos los sectores de la industria y de los comercios de la alimentación.

Construidos en acero inoxidable, están concebidos para durar y para ser instalados incluso en ambientes húmedos.

Working:

The lamp emits ultraviolet germinated rays, that transform oxygen into ozone, destroying the germs by hiper-rusting. It is not necessary demonstrate the effect of the radiation U.V.C. It is totally bacterized, anti-virus, germicized, etc. The U.V. generator cabinet assure the excellent descontamination of the tools. These in compliande with all hygiene norms, find application in every industrial sector and food commerce. They are made of stainless steel, and are made to last and be installed even in humid places.



Barra para colgar accesorios.

Utensil rack.

Barre pour accrocher des accessoires.

375

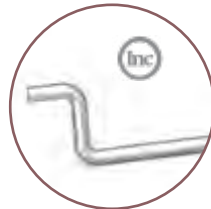

Enchufe con mando a distancia.

Remote controlled RF socket.

Connectez avec télécommande.

374



Fonctionnement:

La lampe émet des rayons ultraviolets germicides, qui transforment l'oxygène en ozone, en détruisant les bactéries par l'hyper-oxidation. Il n'est pas précis démontrer l'effet de la radiation U.V.C. C'est totalement bactericide, antiviral, germicide, etc.

Les armoires générateur U.V. assurent comme ça une excellente décontamination des outils. Cettés armoires, en obeiant avec le normes d'hygiène, trouvent application dans tout les secteurs de l'industrie et des commerces d'alimentation.

Construit en acier inoxydable, il sont conçus pour une longue durée et pour son installation même sous atmosphères humides.

Características:

Construido en chapa de acero inoxidable acabado esmerilado.

Lámpara U.V.C.

Characteristics:

Made of stainless steel polish finished.

Lamp U.V.C.

Caractéristiques:

Construit en acier inoxydable.

Lamp U.V.C.



Capacidad 20 y 40 cuchillos respectivamente

Capacity 20 and 40 knives respectively

Capacité 20 et 40 couteaux respectivement

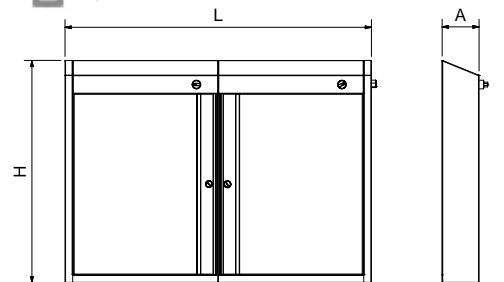

☑ Includido / Included / Inclus ☐ Opcional / Optional / Optionnel

L	A	H	Tensión Voltage Tension	Frecuencia Frequency Fréquence	Potencia Power Puissance	Kg	Barcode	€
523	120	723	220 V	50 Hz	15 W	9,00	040450	551,00
996	120	723	220 V	50 Hz	30 W	17,00	040452	958,00



Repuestos.

Spare parts.
Pièces de rechange.

375

Armario esterilizador de cuchillos mediante Ozono

Ozone sterilizing cabinet for knives

Armoire stérilisateur de couteaux à l'ozone



Características:

Armario construido en acero inoxidable de gran espesor.
Interruptor luminoso On/Off.
Toma de tierra.

Characteristics:

Cabinet made of stainless steel.
On/Off lighting switch.
Ground.

Caractéristiques:

Construit en acier inoxydable.
Interrupteur lumineux On/Off.
Prise de terre.



Enchufe con mando a distancia.
Remote controlled RF socket.
Connectez avec télécommande.

374

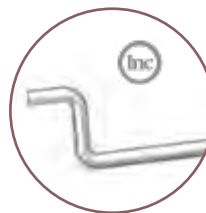

Barra para colgar accesorios.
Utensil rack.
Barre pour accrocher des accessoires.

375



Capacidad 20 y 40 cuchillos respectivamente
Capacity 20 and 40 knives respectively
Capacité 20 et 40 couteaux respectivement

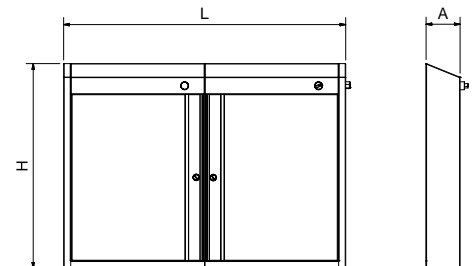

Incluido / Included / Inclus Opcional / Optional / Optionnel



Repuestos.
Spare parts.
Pièces de rechange.

375

L	A	H	Tensión Voltage Tension	Frecuencia Frequency Fréquence	Potencia Power Puissance	Kg	Barcode	€
523	120	723	220 V	50 Hz	6 W	9	040460	473,00
996	120	723	220 V	50 Hz	12 W	17	040462	825,00

Armario inox esterilizador de utillaje y calzado

Stainless steel sterilisers wardrobe for tools and shoes

Armoire inoxydable pour la stérilisation des outils et des chaussures



Características:

3 niveles para colgar botas y zapatos
Sistema de desinfección por ozono.

Characteristics:

3 racks for hanging boots and shoes
Disinfection system:
Ozone

Caractéristiques:

3 niveaux pour ranger bottes et chaussures
Système de désinfection:
Ozone



El pomo admite la colocación de candado.
Handle-holder kit.
Kit porte-manches.



351

Opcional / Optional / Optionnel



Posibilidad de acoplar ruedas ver pág 497
Possibility of assembly wheels, see page 497
Possibilité d'accoupler rouelles, voir page 497

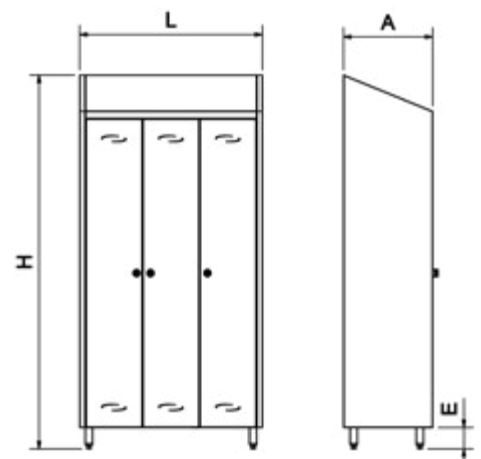

L	A	H	E		Tensión Voltage Tension	Frecuencia Frequency Fréquence	Potencia Power Puissance			€
985	480	2010	115	3	220 V	50 Hz	6 W	57,50	081610	1.797,00

Portacuchillos inox portátil

Portable stainless steel knife holder
Porte couteaux inoxydable transportable



Válido para acoplar a los siguientes modelos de esterilizadores de cuchillos:
Valid for being adapted to the following models knife sterilisers:
Valable pour être adaptés aux modèles suivants de stérilisateur à couteaux:



040452
040462



040450
040460



040472



Capacidad: 20 cuchillos
Capacity: 20 Knives
Capacité: 20 couteaux

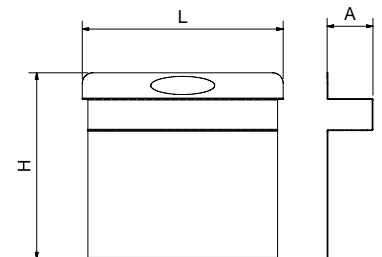

L	H	A	Kg	Barcode	€
377	350	86	2,40	041050	55,00

Accesorios

Accessories
Accessoires



Enchufe con mando a distancia
Remote controlled RF socket
Connectez avec télécommande

Tensión
Voltage
Tension

240V

Frecuencia
Frequency
Fréquence

50 Hz



30
mts.



A23-12v



215



485892



19,00



Consumo máximo admisible 3.600 W.
3.600 W Maximum admissible consumption.
Consommation maximale autorisée 3.600 W.

Repuestos para esterilizadores

Spare parts for sterilizing cabinets

Pièces de remplacement pour stérilisateurs



Resistencia
Résistance
Resistance

900 449040 **175,00**



Interruptor luminoso On/Off
On/Off lighting switch
Interrupteur lumineux On/Off

10 448480 **29,00**



Adhesivo ventana
Sticker for door screen
Autocollant pour fenêtre à porte

10 480222 **8,50**



Cerradura
Lock
Serrure

41 481404 **5,50**



Lámpara de 15 W.
15 W. lamp
Lampe de 15 W.

80 448508 **32,00**



Lámpara de 30 W.
30 W. lamp
Lampe de 30 W.

150 448510 **68,00**



Barra para colgar accesorios
Utensil rack
Barre pour accrocher des accessoires

9 240438 **3,68**



Exterminador de insectos mediante parrilla eléctrica serie UK-INOX

Insect killer by electric grill UK-INOX series

Désinsectiseur à grill Electrique modèle UK-INOX



UK-50 LED



UK-100 LED



UK-240 LED

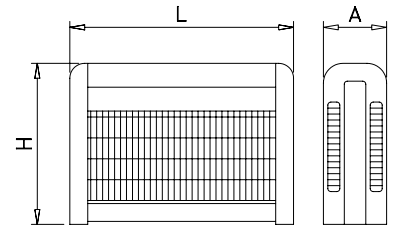

L	A	H	Modelo Model Modèle	Potencia Power Puissance	Frecuencia Frequency Fréquence	Tensión Voltage Tension	Bombilla Light bulb Ampoule	Cobertura Coverage Couverture	Consumo Consumption Consommation	Kg	Barcode	€
380	105	260	UK-50 LED	9 w	50/60 Hz	220-240 V	1x7 W LED	50 m ²	9 W	2,8	485808	82,00
380	105	260	UK-100 LED	16 w	50/60 Hz	220-240 V	2x7 W LED	100 m ²	16 W	3,4	485810	100,00
695	105	285	UK-240 LED	30 w	50/60 Hz	220-240 V	4x7 W LED	240 m ²	30 W	5,7	485812	149,00

Exterminador de insectos mediante trampa adhesiva serie UL

Insect killer by glue board UL series

Désinsectiseur à piège adhésif modèle UL



Características:

Silencioso y discreto. Diseño moderno y compacto. Placa adhesiva de fácil sustitución, con mayor área de captación. El aparato no sólo atrae más insectos que los aparatos convencionales, sino que además lo hace de forma más higiénica. Material de alta calidad, fácil mantenimiento. 2 años de garantía.

Characteristics:

Silent and sober. Modern and compact design. Easy to replace adhesive trap, with higher coverage area. This device not only appeals more insects than the conventional ones, but it also does it in a more hygienic way. High quality material and easy maintenance. 2 years of guarantee.

Caractéristiques:
Silencieux et sobre. Design d'avant garde et compact. Trappe adhésif facile à substituer, avec plus grande zone de couverture. L'appareil non seulement attire plus d'insectes mais encore il les attire d'une forme plus hygiénique. Matériel d'haute qualité et facile maintien. Garantie de 2 années.

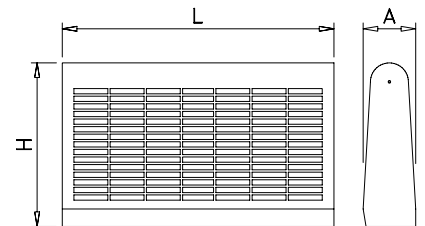

L	A	H	Modelo Model Modèle	Potencia Power Puissance	Frecuencia Frequency Fréquence	Tensión Voltage Tension	Tubo Tube Tube	Cobertura Coverage Couverture	Consumo Consumption Consommation	Kg	Barcode	€
470	95	290	UL-80	35 W	50 Hz	220-240 V	2x15 W	80 m ²	45 W	3,85	485838	119,00

Exterminador de insectos mediante trampa adhesiva serie MR LED

Insect killer by glue board MR LED series
Désinsectiseur à piège adhésif modèle MR LED



Características:

Silencioso y discreto.
Diseño moderno y compacto.
Placa adhesiva de fácil sustitución, con mayor área de captación. (1 unidad incluida)
El aparato no sólo atrae más insectos que los aparatos convencionales, sino que además lo hace de forma más higiénica ya que se quedan pegados a la trampa y no se desprenden del aparato.
Material de alta calidad, fácil mantenimiento.
2 años de garantía.
* Recambios de trampas adhesivas correspondientes a este modelo: 485898

Characteristics:

Silent and discreet.
Modern and compact design.
Easy to replace adhesive trap, with higher coverage area. (1 unit included)
This device not only attracts more insects than the conventional ones, but it also does it in a more hygienic way.
High quality material and easy maintenance.
2 years of guarantee.
* Spare parts of adhesive traps corresponding to this model: 485898

Caractéristiques:

Silencieux et sobre.
Design d'avant garde et compact.
Trappe adhésif facile à substituer, avec plus grande zone de couverture. (1 pièce incluse)
L'appareil non seulement attire plus d'insectes mais encore il les attire d'une forme plus hygiénique.
Matériel d'haute qualité et facile maintien.
Garantie de 2 années.
* Pièces détachées de pièges adhésifs correspondant à ce modèle: 485898.

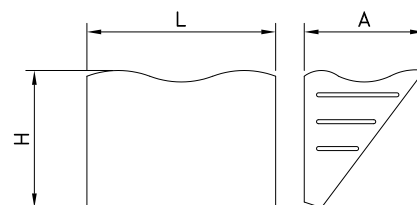

L	A	H	Modelo Model Modèle	Potencia Power Puissance	Frecuencia Frequency Fréquence	Tensión Voltage Tension	Tubo Tube Tube	Cobertura Coverage Couverture	Consumo Consumption Consommation	Kg	Barcode	€
460	180	151	MR-50 LED	9 W	50/60 Hz	100-240 V	1x7 W	50 m ²	9 W	2,7	485805	84,00

Exterminador de insectos serie SP-80 LED

Insect killer by glue board SP-80 LED series
Désinsectiseur à piège adhésif modèle SP-80 LED

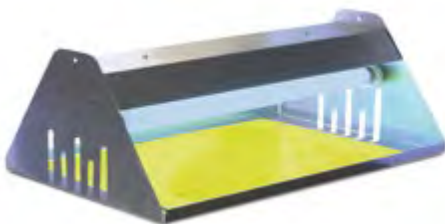

Características:

Silencioso, discreto, sin explosión de insectos y sin olores.
El aparato no sólo atrae más insectos que los aparatos convencionales, sino que además lo hace de una manera más higiénica al quedar el insecto atrapado en su trampa de film adhesivo, resistente a la humedad y rayos UV.
Permite una instalación colgante, incluye kit necesario de cadena y soportes.

Caractéristiques:

Silencieux, discret, sans explosion d'insectes et sans odeurs.
Le dispositif non seulement attire plus d'insectes que les dispositifs classiques, mais aussi le fait de forme plus hygiénique car l'insecte reste attrapé dans son piège de film adhésif, résistant à l'humidité et aux rayons UV.
Il permet une installation en suspension, le kit comprend la chaîne et les supports.

Characteristics:

Silent, discreet and odor free. No insect explosion.
This device not only attracts more insects than the conventional ones, but also does it in a more hygienic way since the insects are trapped on its glue trap, resistant to moisture and UV rays.
For hanged installation, chain and supports included.

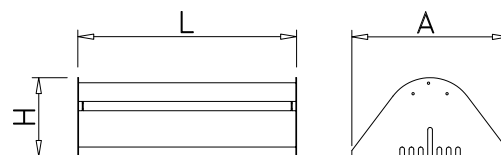

L	A	H	Modelo Model Modèle	Potencia Power Puissance	Frecuencia Frequency Fréquence	Tensión Voltage Tension	Tubo Tube Tube	Cobertura Coverage Couverture	Consumo Consumption Consommation	Kg	Barcode	€
485	160	350	SP-80 LED	16 W	50/60 Hz	100-240 V	2x8 W LED	80 m ²	16 W	4,0	485806	120,00

Exterminador de insectos interior/externo mediante parrilla eléctrica Serie LD120

Insect killer by electric grill indoor / outdoor LD120 Series

Désinsectiseur à grill Électrique intérieur / extérieur LD120 Series

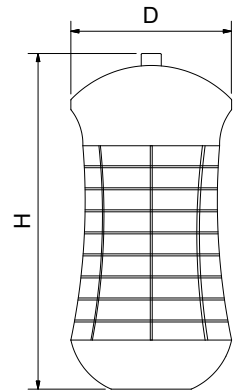

D	H	Modelo Model Modèle	Potencia Power Puissance	Frecuencia Frequency Fréquence	Tensión Voltage Tension	Bombilla Light bulb Ampoule	Cobertura Coverage Couverture	Consumo Consumption Consommation	Kg	Barcode	€
160,5	335	LD-120	8 W	50/60 Hz	220-240 V	UV-A LED 18 w	120 m ²	8 W	0,89	485834	45,00

Exterminador de insectos mediante trampa adhesiva Serie V30

Insect killer by glue board V30 Series

Désinsectiseur à piège adhésif Série V30

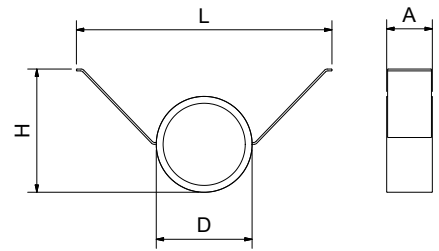

L	A	D	H	Modelo Model Modèle	Potencia Power Puissance	Frecuencia Frequency Fréquence	Bombilla Light bulb Ampoule	Cobertura Coverage Couverture	Consumo Consumption Consommation	Kg	Barcode	€
280	50	105	135	V-30	5 W	50-60 Hz	8 x UV-A LED x 0,63 w	30 m ²	5 W	0,16	485836	20,00

Bombilla LED antimosquitos

Anti-mosquito LED bulb

Bombilla LED antimosquitos



Características:

Bombilla 2 en 1 que sirve como iluminación y como trampa de insectos voladores.

Characteristics:

2-in-1 bulb that serves as lighting and as a trap for flying insects.

Caractéristiques:

Bombilla 2 en 1 que sirve como iluminación y como trampa de insectos voladores.

D	H	Potencia Power Puissance	Frecuencia Frequency Fréquence	Tensión Voltage Tension	Cobertura Bulb socket Douille d'ampoule	Consumo Consumption Consommation	Gr	Barcode	€
165	90	8 W	50/60 Hz	85-265 V	E27	15 W	150	485899	15,00

Exterminador de insectos mediante trampa adhesiva serie BC

Electric glue board fly killer BC series

Exterminateurs d'insectes à trappe adhésif serie BC



Características:

El diseño innovador de la serie BC agrupa la eficiencia del control de insectos voladores y la estética contemporánea y moderna de un aplique de luz. Sus diferentes diseños permiten escoger el modelo que mejor se integre con el lugar de utilización.

Sus ventajas con respecto a otros aparatos son:

Construidos en acero inoxidable.

Diseño exclusivo. Carátulas intercambiables.

Silenciosos.

Ahorro energético: Lámpara de bajo consumo. Sin transformadores, cebadores, etc. garantizando fiabilidad y poco mantenimiento.

Posibilidad de lavarlos o esterilizarlos al poderse introducir en máquinas de lavado, lavavajillas o directamente bajo el agua, desmontando fácilmente y sin herramientas la parte eléctrica.

Ideal para cualquier lugar donde el control de los insectos deba ser discreto y el uso de un exterminador convencional resultaría inapropiado. Recomendado para restaurantes, cafeterías, bares, hoteles, oficinas, tiendas de alimentación, zonas de manipulación de alimentos etc.

Characteristics:

The innovative design of BC series joins the efficiency in flying insect control and the contemporary and modern aesthetic of a wall lamp. Its different designs allow you to choose the most suitable model for the place of usage.

Its advantages in relation to other devices are:

Made of stainless steel.

Exclusive design with exchangeable covers.

Silent.

Power saving with low consumption lamps. Without transformers, chokes, etc. It guarantees liability and low maintenance.

Possibility of washing or sterilizing in washing machines, dishwashers or directly under water, just dismantling the electrical components easily, without any tool.

Perfect for any place where the insect control must be discrete and the usage of a conventional insect killer would be inadequate. It is recommended for restaurants, cafes, bars, hotels, offices, food shops, food preparation areas, etc.

Caractéristiques:

Le design innovateur du modèle BC attache l'efficacité du control des insectes volants et l'esthétique contemporaine et moderne d'un applique. Son designs différents permettent choisir le modèle que plus s'intègre avec l'endroit d'utilisation.

Les avantages par rapport autres modèles sont :

Construit en acier inoxydable.

Design exclusif avec façades interchangeables.









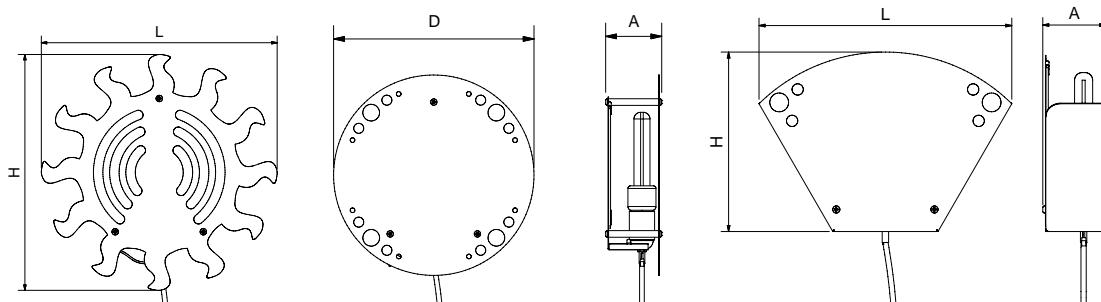























Silencieuses.

Économie énergétique. Lampe de consommation bas sans transformateur ou poire qui garantisse fiabilité et maintenance. Possibilité de le laver ou le stériliser puisque il peut se mettre dans machines à laver, lave-vaisselles ou directement sous l'eau. Facile à démonter sans outils.

Parfait pour quelque endroit ou le control des insectes doit être discret et l'usage d'un exterminateur conventionnel serait inadéquat. Racommandé pour restaurants, cafés, bars, hôtels, bureaux, magasins d'alimentation, zones de manipulation d'aliments, etc.

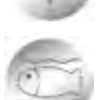



	L	D	A	H	Modelo Model Modèle	Potencia Power Puissance	Cobertura Coverage Couverture	W	Tensión Voltage Tension	Frecuencia Frequency Fréquence	Kg	Barcode	€
		300	84		Industrial		20 W	50 m ²	20 W	220/240 V	50/60 Hz	1,1	085810 108,00
													086010 126,00
	336		84	240	AP-INOX		20 W	50 m ²	20 W	220/240 V	50/60 Hz	1,7	085812 117,00
													086012 135,00
	350		84	350	Sol		20 W	50 m ²	20 W	220/240 V	50/60 Hz	0,96	085802 135,00
													086002 151,00
	280		84	300	Luna		20 W	50 m ²	20 W	220/240 V	50/60 Hz	1,13	085804 110,00
	300		84	345	Estrella		20 W	50 m ²	20 W	220/240 V	50/60 Hz	0,94	085806 110,00
	343		84	269	Nube		20 W	50 m ²	20 W	220/240 V	50/60 Hz	1,10	085808 110,00
	271		84	315	Manzana		20 W	50 m ²	20 W	220/240 V	50/60 Hz	1,04	085814 110,00
	310		84	293	Cerezas		20 W	50 m ²	20 W	220/240 V	50/60 Hz	0,96	085816 110,00
	300		84	300	Pollería		20 W	50 m ²	20 W	220/240 V	50/60 Hz		085818 110,00
	300		84	300	Queso		20 W	50 m ²	20 W	220/240 V	50/60 Hz		085821 110,00
	300		84	300	Carnicería		20 W	50 m ²	20 W	220/240 V	50/60 Hz		085822 110,00
	300		84	300	Charcutería		20 W	50 m ²	20 W	220/240 V	50/60 Hz		085824 110,00
	300		84	300	Variantes		20 W	50 m ²	20 W	220/240 V	50/60 Hz		085826 110,00
	300		84	300	Panadería		20 W	50 m ²	20 W	220/240 V	50/60 Hz		085828 110,00
	300		84	300	Pescadería		20 W	50 m ²	20 W	220/240 V	50/60 Hz	1,09	085829 110,00

Atrapador de insectos Tephri Trap

Tephri Trap insect trap
Piège à insectes Tephri Trap



Characteristics:
Insect trap provided with four holes to increase the flow of the attractant lure
Versatile since it can operate in dry mode by means of attractant patches or in wet mode by means of hydrolyzed proteins (Nulure, Buminal, etc.) Capacity: 400 cc.

Caractéristiques:
Piège à insectes avec 4 trous pour augmenter le flux des insectes appâtes
Versatile puisqu'on peut l'utiliser en sec avec des patchs et en humide avec des protéines hydrolysées -Capacité 400 cc.

Características:

Atrapador de insectos con cuatro agujeros para aumentar el flujo de los atrayentes
Versátil, puesto que puede trabajar en seco mediante parches atrayentes y en húmedo mediante proteínas hidrolizadas (Nulure, Buminal, etc.) Capacidad 400 cc.

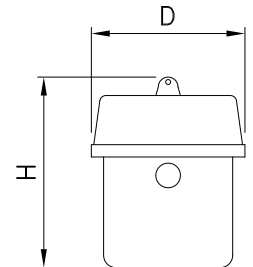

D	H	Gr	Barcode	€
125	155	136	485802	8,00

Atrapador de insectos Easy Trap

Easy Trap insect trap
Piège à insectes Easy Trap



Características:

Fácil manejo, posibilidad de trabajar en seco y en húmedo. Gran eficacia.
Diseñado especialmente para atrapar todas las moscas de las frutas (Ceratitis, Bactrocera, Ragholetis, Anastrepha, etc.), pero puede atrapar otros muchos insectos si se usa con los atrayentes adecuados (por ej. Drosophilas, moscardas y avispa).
Revolucionario diseño que permite una óptima dispersión de los atrayentes de su interior y un dispositivo seguro de retención de los insectos.
Facilidad para ser colgado por su percha adaptable.

Caractéristiques:
Facile usage, possibilité d'utiliser en sec ou en humide, Grande efficacité
Conçu pour attraper spécialement toutes les mouches (Ceratitis, Bactrocera, Ragholetis, Anastrepha, etc) mais peut également attraper d'autres insectes si on l'utilise avec les appâts appropriés (par ex. Drosophilas, moscardas et guêpes)
Révolutionnaire design qui permet une dispersion optimum des appâts en son intérieur et un dispositif sûr de retenue des insectes
S'accroche facilement grâce à son crochet adaptable

Characteristics:
Easy to use. Two operating modes: dry and wet. High efficiency.
Designed to catch fruit flies (Ceratitis, Bactrocera, Ragholetis, Anastrepha, etc.) In addition, if the adequate attractant lures are used, it can also trap many other insects such as drosophilas, blow flies and wasps.
State of the art design for an optimal spreading of the attractant lures outwards with an insect retention security device
Its adaptable sling bar makes it easy to hang.

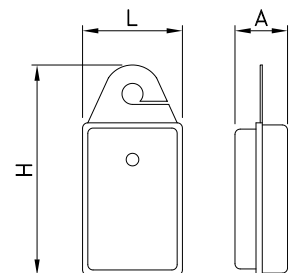

L	A	H	Gr	Barcode	€
95	50	200	56	485804	6,00

Relación de repuestos para exterminadores de insectos

List of spares for insect killers













Liste de pièces de rechange pour destructeurs d'insectes

	Modelo Model Modèle		Bombilla / Tubo Light bulb Ampoule	Trampas adhesivas Adhesive traps Trappes adhésives	Estárter Starter / Choke Starter
485808	UK-50 LED		 485868		 485870
485810	UK-100 LED		 485868		 485870
485812	UK-240 LED		 485868		 485870
485838	UL		 485860	 485872	 448516
485805	MR LED		 485868	 485898	
485806	SP-80 LED		 485874	 485852	 485871
485834	LD120		 485863		
0858xx	BCxx		 485886	 485880	

Repuestos para exterminadores de insectos

Spares for insect exterminators

Recharges pour exterminateurs d'insectes









		Unidades por caja Box units Unités par boîte		
				€
	20 W - Luz negra (E27 x 160) 20 W - Black light (E27 x 160) 20 W - Lumière noire (E27 x 160)	1	485886	13,00
	15 W - Luz LED blanca (E27 x 135) 15 W - White LED light (E27 x 135) 15 W - Lumière blanche LED (E27 x 135)	1	485887	17,00
	18 W - UV-A LED repuesto para exterminador LD120 UV-A LED 18 W for LD120 exterminator UV-A LED 18 W pièce de rechange pour tue-mouches LD120	1	485863	11,00
	7 W - Bombilla UV-A LED repuesto para exterminadores LED Spare bulb UV-A LED 7W for LED exterminators Ampoule UV-A LED 7W pièce de rechange pour tue-mouches LED	1	485868	22,00
	8 W - UV-A LED repuesto para exterminador SP-80 LED UV-A LED 8 W for LED SP-80 exterminator UV-A LED 8 W pièce de rechange pour tue-mouches SP-80 LED	1	485874	14,00
	Tubo 8 W	1	485856	7,00
	Tubo 11 W	1	485857	9,00
	Tubo 15 W	1	485858	12,00
	Tubo 15 W	1	485860	12,00
	Tubo 40 W	1	485866	11,55
	Tubo 18 W	1	485862	18,00
	Estarter para 15 W Starter / Choke for 15 W Starter pour 15 W	1	448516	4,20
	Estarter para 30 W Starter / Choke for 30 W Starter pour 30 W	1	448518	5,30
	Balasto (Reactancia) para UK-40 y UK-80 Reactance / Ballast for UK-40 & UK-80 Réactance pour UK-40 et UK-80	1	485820	16,00
	Balasto (Reactancia) para UK-240 Reactance / Ballast for UK-240 Réactance pour UK-240	1	485822	17,00
	Transformador 4000 V. repuesto para exterminadores LED Spare convert 4000 V. for LED exterminators Transformateur 4000 V. pièce de rechange pour tue-mouches LED	1	485870	28,50
	Transformador repuesto para exterminador SP-80 LED Spare convert for SP-80 LED exterminator Transformateur pièce de rechange pour tue-mouches SP-80 LED	1	485871	18,00



Repuestos para exterminadores de insectos

Spares for insect exterminators







Recharges pour exterminateurs d'insectes

		Unidades por caja Box units Unités par boîte			
					€
	Trampas adhesivas para SP-80 (395x300 mm.) Adhesive traps for SP-80 (395x300 mm.) Trappes adhésives pour SP-80 (395x300 mm.)	6		485852	39,00
	Trampas adhesivas para V-30 Adhesive traps for V-30 Trappes adhésives pour V-30	6		485855	4,00
	Trampas adhesivas para UL-80 (450x290 mm.) Adhesive traps for UL-80 (450x290 mm.) Trappes adhésives pour UL-80 (450x290 mm.)	6		485872	35,00
	Trampas adhesivas para MR-40 (460x175 mm.) Adhesive traps for MR-40 (460x175 mm.) Trappes adhésives pour MR-40 (460x175 mm.)	5		485898	30,00
	Trampas adhesivas para MR-70 Adhesive traps for MR-70 Trappes adhésives pour MR-70	6		485897	34,00
	Trampas adhesivas Adhesive traps Trappes adhésives	6		485880	19,00

Repuestos para exterminadores de insectos

Spares for insect exterminators

Recharges pour exterminateurs d'insectes

		Tensión Voltage Tension	Frecuencia Frequency Fréquence					€
	Enchufe con mando a distancia Remote controlled RF socket Connectez avec télécommande	240V	50 Hz	30 mts.	A23-12v	215	485892	19,00
	Adaptador enchufe tipo H Type H plug adapter Adaptateur pour prise électrique type H	220V	50 Hz			56	485878	8,00

Contenedor de desperdicios con tapa y ruedas

Waste bin with lid and wheels

Conteneur à ordures avec couvercle et roulettes

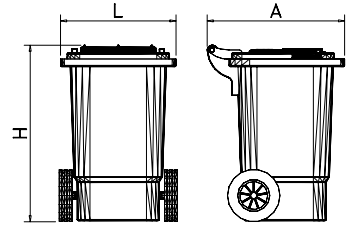

L	A	H	Capacity	Weight	Color	Code	Price (€)
470	550	670	60 lts	8,75	Grey	486002	82,00
					Green	486042	
					Blue	486038	
					Yellow	486040	
					Brown	486044	
470	550	925	120 lts	10,50	Grey	486046	92,00
					Blue	486034	
					Green	486032	
					Yellow	486036	
					Brown	486030	
580	740	1.070	240 lts	14,50	Red	486035	158,00
					Grey	486037	
					Blue	486084	
					Green	486082	
					Yellow	486086	
					Brown	486080	
					Brown	486088	

Características:

Ampliamente resistentes al calentamiento, a las heladas y a los productos químicos.

Characteristics:

Highly resistant to heat, extreme cold and chemical products.

Caractéristiques:

Très résistant aux hautes températures, aux gelées et aux produits chimiques.

L	A	Capacity	Weight	Color	Code	Price (€)	
470	550	60 lts 120 lts	230	Grey	486090	38,00	
				Green	486091		
				Blue	486092		
				Yellow	486093		
				Brown	486094		
580	740	240 lts	300	Grey	486099	45,00	
				Green	486120		
				Blue	486122		
				Yellow	486124		
				Brown	486126		
					Yellow	486128	



Capacity	Code	Price (€)
60 lts	486050	38,50
120 lts	486060	38,50
240 lts	486061	38,50

Pedal opcional
Optional pedal
Pédale en option

Pedal opcional
Optional pedal
Pédale en option

Pedal opcional
Optional pedal
Pédale en option



Capacity	Weight	Code	Price (€)
60 lts 120 lts 240 lts	680	486096	39,00
60 lts 120 lts	110	486097	21,00
240 lts	150	486098	27,00

El precio es por pareja.
The pair is included in the price.
Le paire est inclus dans de prix.

Contenedor de desperdicios

Waste bin
Conteneur à ordures

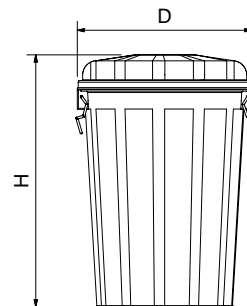

H	D				€
600	455	70 lts	2,5	486023	20,00
730	495	95 lts	3,0	486022	31,00

Contenedor inoxidable con tapa

Stainless container with lid
Conteneur inoxydable avec couvercle

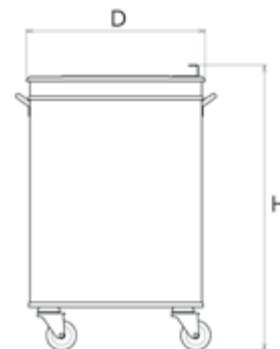

H	H1	D				€
600	530	380	50 lts	7,10	486004	187,00

Contenedor inoxidable con tapa de apertura a pedal

Pedal operated stainless container with lid
Conteneur inoxydable avec couvercle à pédale

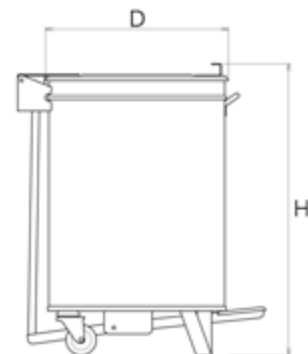

H	H1	D				€
605	540	450	75 lts	12,25	486006	248,00

Contenedor porta-bolsas con tapa y ruedas

Bag-holder container with lid and wheels
Conteneur porte-sacs avec couvercle et rouelles

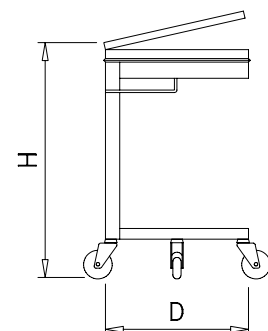

D	H			€
450	850	3,25	486010	235,00

Contenedor porta-bolsas sistema "tijera", apertura a pedal

Pedal operated folding system bag-holder container
Conteneur porte sacs système pliant à pédale

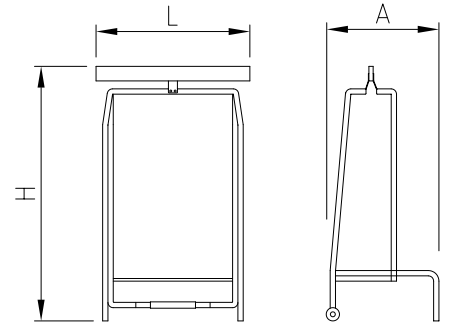

L	A	H	Kg	Barcode	€
470	570	1.000	6,65	486020	145,00

Contenedor inoxidable con tapa y ruedas especial panadería

Stainless steel dustbin with lid and wheels. Special for bakery
Poubelle inoxydable avec couvercle et rouelles. Spécial pour boulangerie

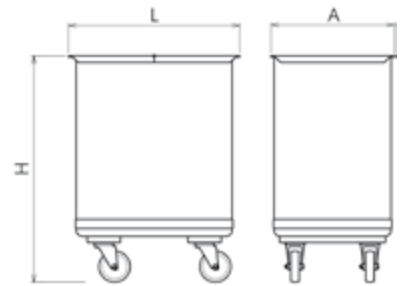

L	A	H	lts	Kg	Barcode	€
610	395	725	115	19,00	486008	470,00

Papelera con tapa y ruedas 70 lt

Container with lid and wheels 70 l.
Poubelle avec couvercle et roulettes 70 lt



Características:

Fabricada en acero inoxidable acabado brillo.

Characteristics:

Made out of stainless steel, polished finishing.

Caractéristiques:

Fabriquée en acier inoxydable finition brillante.

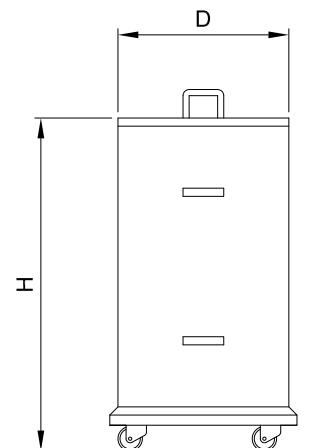

D	H	lts	Kg	Barcode	€
420	730	70	10,50	486076	242,00

Contenedor inox para vaciado de bandejas de comida rápida fast-food

Stainless steel waste bin for fast food restaurants

Poubelle en acier inoxydable spéciale snack restauration rapide Fast-food



Apertura a pedal
Foot pedal opening
Ouverture à pédale



080662

080660



Características de fabricación:

Fabricado totalmente con acero inoxidable. Sistema patentado de pedal. Permitirá al usuario abrir la trampilla sin necesidad de usar las manos. La trampilla también se puede abrir con la mano en caso de requerirlo. Las varillas de la parte superior del mueble facilitan la colocación de las bandejas. La tolva de caída de los desperdicios es de una sola pieza y no posee juntas ni huecos, lo que facilita la limpieza. Asa de la puerta ergonómica. El contenedor posee dos ruedas, lo que permite desplazarlo con poco esfuerzo. Provisto de dos tacos regulables en altura para adaptarse a cualquier clase de suelo, evitando desplazamientos accidentales o no deseados. Insonorizado en todas sus piezas.

Manufacturing characteristics:

Fully made of stainless steel. Pedal operated patented system. It will allow the user to open the lid avoiding the use of his hands. The lid can also be opened with the hand if necessary. Rods on the top that make easier the placing of the empty trays. Receptacle for scraps made in one only piece, without joints or hollows. Ergonomic handle. It can be moved effortlessly by means of two wheels. It can be adapted to any floor unevenness thanks to two adjustable blocks. All its components are soundproofed.



486074 36,00 393

Contenedor de plástico con tapa 55 lts

Plastic bin with lid 55 lts
Conteneur 55 lts



480662 19,00

Adhesivo trampilla
Sticker for lid
Autocollant pour trappe



486022 31,00 386

Contenedor de desperdicios 95 lts
Waste bin 95 lts
Conteneur à ordures 95 lts



480664 19,00

Adhesivo para pedal
Sticker for pedal
Autocollant pour pédale



485016 4,00

Ruedas
Wheels
Rouelles



- Incluido** / Included / Inclus
- Opcional** / Optional / Optionnel

Caractéristiques de fabrication:
Fabriqué totalement en acier inoxydable. Système patenté de pédale. Permettra à l'utilisateur ouvrir la trappe sans avoir besoin d'utiliser les mains. La trappe peut aussi être ouverte avec les mains. Les tiges de la partie supérieure du meuble facilitent le rangement des plateaux. La trémie de déchets est construite dans une seule pièce et elle ne possède pas de joints, ce qui facilite le nettoyage. Tireur ergonomique. La poubelle a deux rouelles, ce qui permet de le déplacer sans effort. Elle est pourvue de deux vérins réglables en hauteur pour s'adapter au plancher. Toute la poubelle est insonorisée.

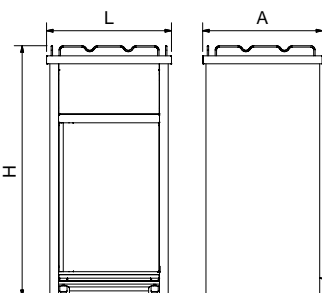

L	A	H	litros	Kg	080660	€
625	600	1.255	95 lt	46,0	080660	1.150,00
540	410	1.016	55 lt	30,5	080662	1.000,00

Mesa mural desbarasado y reciclaje con puerta

Waste and recycling wall-side table

Table murale pour trémie à déchets et recyclage



Características:

Laterales forrados en acero inoxidable.
Aro para tolva de desbarasado color azul.
Tapa para aro.

Characteristics:

Sides covered with stainless steel panels.
Blue ring for waste chutes.
Ring lid.

Caractéristiques:

Latérales recouvertes en acier inoxydable.
Cercle bleu pour trémies à déchets.
Couvercle.

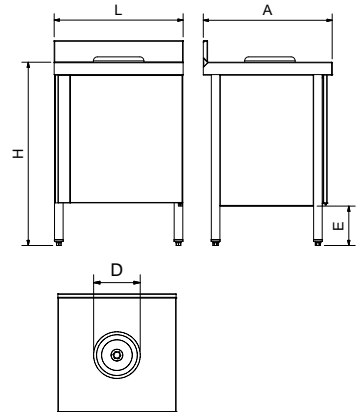

L	A	H	D	E	Kg	Barcode	€
600	600	850	235	200	23	074438	601,00
600	700	850	235	200	28	074437	800,00

Contenedor de desperdicios y reciclaje

Waste and recycling container

Conteneur à ordures et recyclage

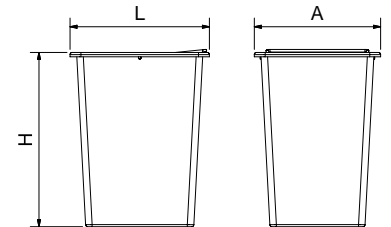

L	A	H	Capacity	Color	Gr	Barcode	€
315	285	380	26 lts	Blue	400	486024	24,00
				Green		486026	
				Yellow		486028	
				Grey		486025	

Centro de reciclado 4 elementos

Quadruple recycling station 4 elements recycler

Centre de recyclage de quatre éléments

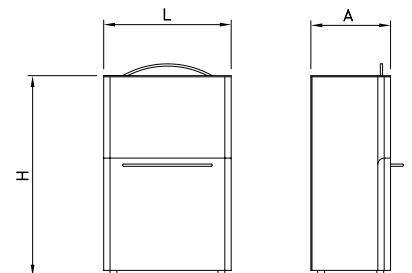

L	A	H	Capacity	Kg	Barcode	€
560	350	880	72 lts	18,0	486068	550,00

Papelera de reciclaje
 Recycling bin
 Poubelle de recyclage

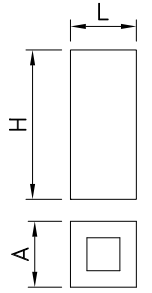

L	A	H	Capacity	Weight	Color	Code	Price
300	300	680	58 lts	6,80	Blue	486104	228,00
					Red	486106	
					Green	486108	
					Yellow	486110	

Contenedor para reciclado
 Recycling container
 Récipient pour le recyclage

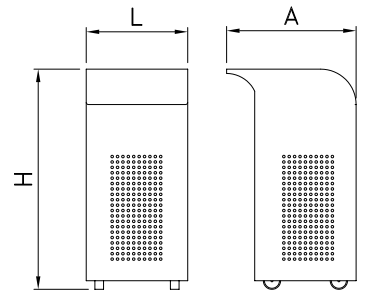

L	A	H	Capacity	Weight	Color	Code	Price
470	600	1.020	270 lts.	28,0	Green	486062	795,00
					Blue	486064	
					Brown	486066	

Contenedor de desperdicios 80L serie GO
 Waste bins 80L GO series
 Conteneur à déchets 80L série GO

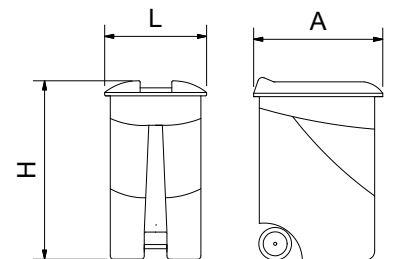

L	A	H	Capacity	Weight	Color	Code	Price
400	575	785	80 lts.	3,34	Grey	486150	65,00
					Blue	486152	
					Green	486154	
					Yellow	486156	

Contenedor de reciclaje vertical

Vertical recycling waste bin station
Conteneur de recyclage vertical



Wholly made in stainless steel AISI 304, it has been designed for a selective collection of waste products. Its column-shape design allows you to get a better use of space in working areas.

It is composed of a front door with four lids provided with an automatic shutting that leads to the different inner containers. Total capacity of 104 litres divided into four tight compartments of 26 litres each one.

With declined roof to avoid dirtiness deposits. Its free space underneath enables an easy cleaning.

Originally it is designed to lodge different kind of waste products:

- Paper and paperboard.
- Cans and plastic containers.
- Glass bottles
- Trash.

Later on you will be able to make your own configuration by means of the rubber ring for wastes and stickers available according to the products you need to recycle.

Faites entièrement en acier inox AISI 304, il a été conçu pour une collecte sélective des déchets. Dessiné en forme de colonne pour une meilleure utilisation de l'espace dans les zones de travail.

Porte frontale avec quatre trappes munies de fermeture automatique. Chaque trappe donne accès à un conteneur différent.

Capacité totale de 104 litres divisé en quatre compartiments de 26 litres chacun.

Avec toit incliné pour éviter les dépôts de saleté. Son espace libre en dessous permet un nettoyage facile.

A l'origine il est destiné à loger des différents types de déchets:

- Papiers et cartons.
- Récipient en plastique.
- Bouteilles en verre
- Des ordures.

Postérieurement vous pourrez faire votre propre configuration à l'aide de la bague en caoutchouc pour les déchets et les autocollants disponibles selon les produits dont vous avez besoin de recycler.

Recipientes interiores estancos, independientes y extraíbles de 26 lts de capacidad fabricados en plástico 100 % reciclable. Disponen de asas para su fácil manipulación.

It is provided with detachable tight containers of 26 litres of capacity, made of plastic 100% recyclable and with handles for an easy handling.

Il est fourni avec conteneurs étanches détachables de 26 litres de capacité, fabriqués en plastique 100% recyclables et avec des poignées pour une manipulation facile.

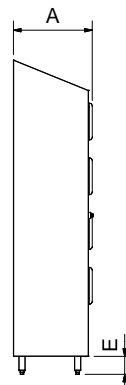
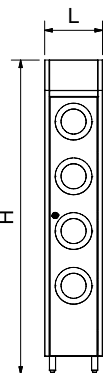

Gestione sus residuos de una manera eficaz, ocupando el menor espacio posible.

Su construcción en acero inoxidable permite su ubicación en exteriores.

Ideal en cocinas, vestuarios, oficinas, instalaciones deportivas, etc.

Manage your waste products efficiently while optimizing room.

It is made of stainless steel, which allows to be installed at any outdoor space.

Ideal for kitchens, dressing-rooms, offices, sport facilities, etc.

Organisez vos déchets avec efficacité et optimisez votre espace.

Il est fabriqué en acier inoxydable, ce qui permet son installation à tout espace extérieur.

Idéal pour salles de cuisines, dressing-rooms, bureaux, installations sportives, etc.

Armario fabricado totalmente en acero inoxidable, concebido para la recogida selectiva de residuos. Mejor aprovechamiento del espacio en el entorno de trabajo gracias a su diseño en modo de columna.

Formado por una puerta frontal con cuatro trampillas provistas de cierre automático, que dan acceso a los diferentes contenedores interiores.

104 litros de capacidad total repartida en cuatro contenedores de 26 lts cada uno.

Techo inclinado para evitar depósitos de suciedad, el espacio inferior libre permite limpiar debajo del mueble. En su configuración estándar está preparado para reciclar:

- Papel y cartón.
- Envases.
- Materia orgánica, basura general.
- Vidrio.

Posteriormente usted podrá personalizar su contenedor mediante aros y adhesivos en función de los residuos que desee reciclar.









L	A	H	E	Kg	081440	€
370	505	2.010	120	33		998,00

Repuestos para contenedor de reciclaje vertical

Spare parts for vertical recycling waste bin

Pièces de remplacement pour conteneur de recyclage vertical

		Gr	€				
	Adhesivo reciclar Papel y cartón Paper and paperboard recycling sticker Autocollant recyclage de papier et carton		481420 27,00				
	Adhesivo reciclar Materia orgánica Trash recycling sticker Autocollant recyclage des ordures		481422 27,00				
	Adhesivo reciclar Envases y plásticos Cans and plastic containers recycling sticker Autocollant recyclage récipients en plastique		481424 27,00				
	Adhesivo reciclar Vidrio Glass bottles recycling sticker Autocollant recyclage de bouteilles en verre		481426 27,00				
	Adhesivo Reciclaje Recycling sticker Autocollant recyclage		481428 27,00				
	Aro azul con trampilla para contenedor de reciclaje vertical Blue ring with self-closing trap for recycling waste bin Cercle bleu avec trappe battante pour conteneur de recyclage	750	<table border="1"> <tr><td>081442</td></tr> <tr><td>081444</td></tr> <tr><td>081446</td></tr> <tr><td>081448</td></tr> </table> 48,00	081442	081444	081446	081448
081442							
081444							
081446							
081448							

Papelera inox de 70 lt apertura frontal

Inox wastepaper bin 70 litres, front opening

Corbeille à papier inox 70 litres, ouverture frontale

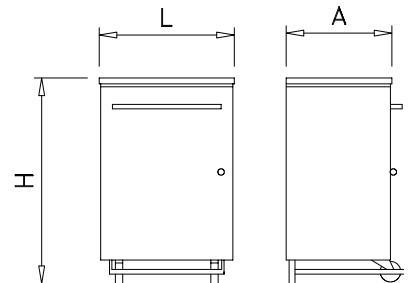

L	A	H	Kg	€
370	470	715	7,0	486070 396,00

Papelera basculante en acero inoxidable

Stainless steel toggling wastebin

Conteneur basculant en acier inox



Características:

Construida totalmente en acero inoxidable. Fácil apertura para su carga y descarga, tan solo levantando su caperuza superior.

Characteristics:

Totally made of stainless steel. Easy opening for charge and discharge, by only lifting the upper cover.

Caractéristiques:

Fait tout en acier inox. Facile ouverture pour le charger et le décharger, seulement en levant la couverture supérieure.

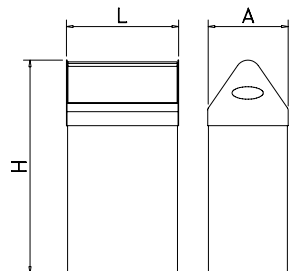



Apertura Opening Ouverture	L	A	H	Kg	€
Manual Manual Manuel	350	250	680	44 lbs	6,85 080604 270,00
Pedal opcional Optional pedal Pédale optionel				0,4	080606 46,00

Repuestos para contenedores inoxidables

Spare parts for inox-dustbin

Replacements pour poubelles

	Modelos Models Modèles	Gr	Barcode	€
 <p>Rueda repuesto para contenedores inox Spare wheel for stainless steel dustbin Rouelle de rechange pour poubelle inoxydable</p>	486004	120	486052	10,00
	486006			
	486008	30	486054	20,00
		50	486058	7,00
 <p>Goma de repuesto para contenedor porta-bolsas Spare rubber for bag-holder container Caoutchouc de rechange conteneteur porte-sacs</p>	486010	35	486056	14,00

Papelera de plástico con pedal

Plastic bin with pedal

Poubelle en plastique avec pédale

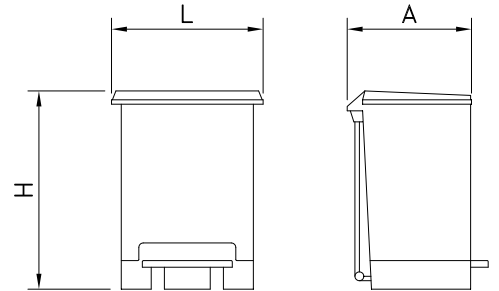

L	A	H	Gr	Barcode	€
330	270	450	26 lbs	1,80	486072 20,00

Contenedor higiénico sanitario con apertura a pedal

Pedal operated sanitary bin

Poubelle hygiénique sanitaire à pédale



Características:

Unidad diseñada exclusivamente para la recogida de residuos como compresas, tampones y pañales. Construidos en ABS color blanco, cuentan con pedal y tapa basculante integrados, además de cabezal reversible.

Characteristics:

Specially designed for waste collection such as pads, tampons and diapers. Made of white ABS, with integrated pedal, swing top lid and masking tray.

Caractéristiques:

Spécialement conçu pour la collecte des déchets tels que tampons, serviettes-hygiéniques et couches. Fabriqué en ABS blanc, avec pédale intégrée, couvercle pivotant supérieur et vanne de masquage.

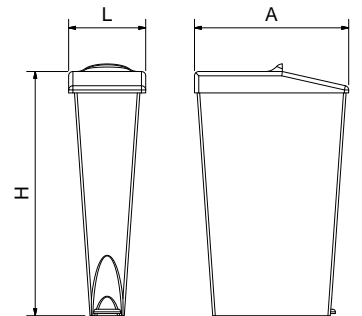

L	A	H	Gr	Barcode	€
180	360	570	18 lbs	1,80	460248 43,00

Contenedor de plástico con tapa 55 litros

Plastic bin with lid 55 liters

Conteneur 55 lts

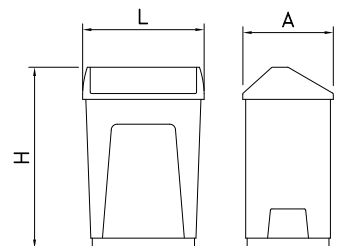

L	A	H	Gr	Barcode	€
415	320	620	55 lbs	3,0	486074 36,00

Cubo pedal baño con papelera interior

Pedal bin for toilet
Poubelle sale de bains

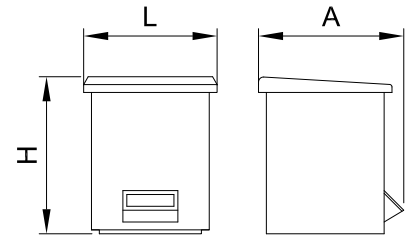

L	A	H	lit	Gr	Barcode	€
270	230	280	8	809	486112	18,00

Papelera

Wastepaper bin
Corbeille à papiers

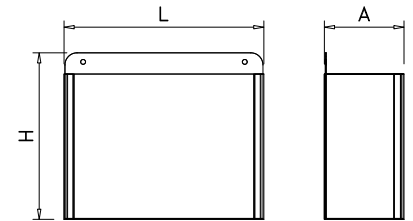

L	A	H	lit	Kg	Barcode	€
330	130	275	11 lts	2,20	080602	55,00

Papelera modelo Design

Design model wastepaper bin
Corbeille à papiers modèle Dèsign

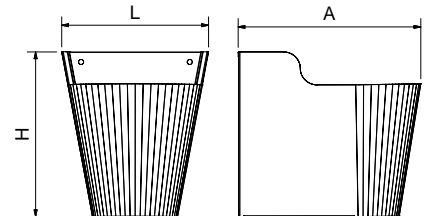

L	A	H	lit	Kg	Barcode	€
340	265	300	18 lts	2,3	080608	77,00

Papelera con tapa y pedal

Pedal operated wastepaper bin with lid
Corbeille à papiers avec couvercle et pédale

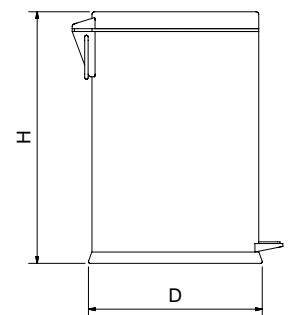

D	H	lit	Kg	Barcode	€
200	310	5 lts	2,0	486012	25,00
250	390	12 lts	3,9	486014	39,00
290	650	30 lts	5,9	486016	86,00

Dispensador de bolsas

Whole dispenser for plastic bags
Conjoint dispensateur de sacs

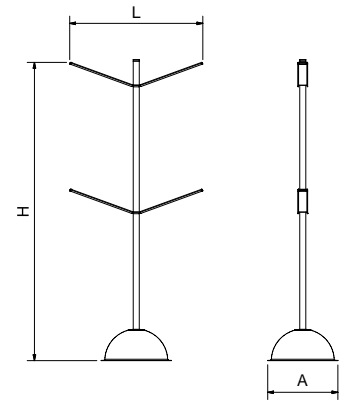

L	A	H	Kg	Barcode	€
550	290	1.245	9,0	080426	162,00

Conjunto dispensador de guantes y bolsas en rollo

Dispensing unit for gloves and snappy bags in roll
Conjoint dispensateur de gants et sacs en roulot



Características:

El conjunto y sus complementos cumplen con toda la normativa aplicable al respecto de la Unión Europea. Dispensador de guantes que, por separado, admite colocación de sobremesa. Dispensador de bolsas de hasta 370 mm. de longitud, semi-hermético, que, por separado, admite colocación a pared. Soporte para dispensadores y papeleras, construido específicamente para favorecer la estabilidad y la higiene.

Characteristics:

The whole and its items obey with all the applicable norms from the European Union and the Spanish state. Gloves dispenser, that separately, it admits to be put in table. Plastic bags dispenser of 370 length maximum, semi-hermetic, that separately it admits to be put in wall. Dispensers and wastebins support, made specifically to improve the stability and the hygiene. Wastebin. Totally made in stainless steel.

Caractéristiques:

Le conjoint et ses compléments obéissent avec les normes applicables de la Union Européenne et l'Etat Espagnol. Dispensateur de gants, que par séparé, admet d'être placé sur table. Dispensateur de sacs jusqu'à 370 mm de longueur, semi-hermétique, que par séparé, admet d'être placé sur mur. Support pour dispensateurs et conteneurs, fait spécifiquement pour favoriser l'estabilité et l'hygiène.

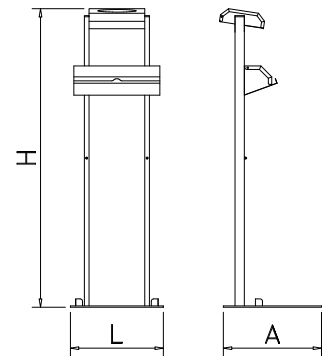

L	A	H	Kg	Barcode	€
422	365	1.290	9,6	080402	270,00

Conjunto dispensador de guantes y bolsas colgantes

Dispensing unit for gloves and snappy hanging flat bags
Conjoint dispensateur de gants et sacs suspendus



Características:

El conjunto y sus complementos cumplen con toda la normativa aplicable al respecto de la Unión Europea y del Estado Español. Dispensador de guantes que por separado, admite colocación de sobremesa. Soporte para dispensadores y papeleras, construido específicamente para favorecer la estabilidad y la higiene.

Characteristics:

The whole and its items comply with all the applicable norms from the European Union and the Spanish state. Gloves dispenser, that separately, it admits to be put in table. Dispensers and wastebins support, made specifically to improve the stability and the hygiene.

Caractéristiques:

Le conjoint et ses compléments obéissent avec les normes applicables de la Union Européenne et l'Etat Espagnol. Dispensateur de gants, que par séparé, admet d'être placé sur table. Support pour dispensateurs et conteneurs, fait spécifiquement pour favoriser l'estabilité et l'hygiène.

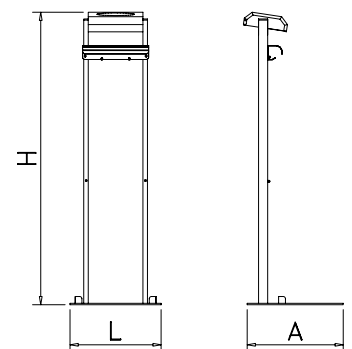

L	A	H	Kg	Barcode	€
422	365	1.290	8,5	080412	245,00

Conjuntos dispensadores de guantes y bolsas con papeleras

Dispensing unit for gloves and snappy bags with wastebins

Conjoints dispensateurs de gants et sacs avec conteneurs



€

Con papelera adosada
With joint wastebin
Avec conteneur adossé

990140102 **325,00**



Apertura
Opening
Ouverture



€

Manual
Manual
Manuel

990140202 **540,00**

Con papelera basculante
With toggling wastebin
Avec conteneur basculant

Con pedal
With pedal
Avec pédale

990140601 **586,00**



€

Con papelera adosada
With joint wastebin
Avec conteneur adossé

990140302 **300,00**



Apertura
Opening
Ouverture



€

Manual
Manual
Manuel

990140402 **515,00**

Con papelera basculante
With toggling wastebin
Avec conteneur basculant

Con pedal
With pedal
Avec pédale

990140701 **561,00**

Dispensador de guantes
 Gloves dispenser
 Distributeur de gants



Características:
 Construidos totalmente en acero inoxidable acabado satinado. La colocación del dispensador puede ser mural o de sobremesa. Como dotación estándar cuentan con tacos antideslizantes para su colocación de sobremesa.

Characteristics:
 Tottally made of stainless steel. The placing of both may be on table or on wall. As standard equipment they have anti-slipping pegs for its placing on table.

Caractéristiques:
 Construit totalement en acier inoxydable brillant. Comme équipement standar ils ont ventouses anti-glissants pour se placement sur table.

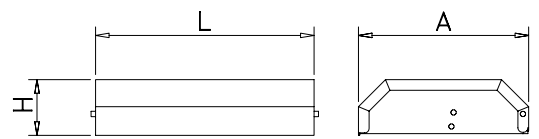

L	A	H	Gr	Barcode	€
270	195	65	900	080404	53,00

Dispensador de bolsas en rollo
 Roll bag dispenser
 Distributeur de sacs sur rouleau

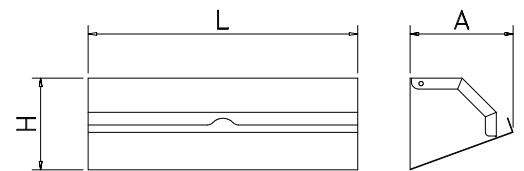
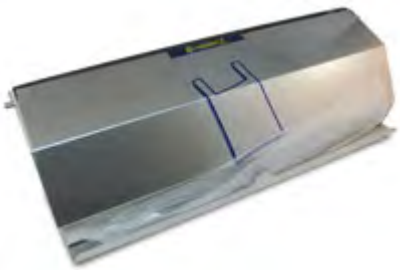

L	A	H	Kg	Barcode	€
375	140	125	1,25	080406	57,00

Dispensador de bolsas colgantes
 Dispenser for snappy hanging flat bags
 Distributeur de sacs suspendus



Características:
 Distancia entre ejes regulable, para adaptarse a cualquier medida entre taladros de la bolsa.

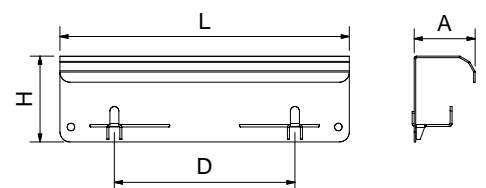

L	A	H	D	Kg	Barcode	€
290	61	86	90-215	0,51	080414	30,00

Caractéristiques:
 Distance entre axes réglable afin de s'adapter à quelque mesure entre les trous du sac.

Characteristics:
 Adjustable axle distance to adapt any measure between the bag holes.

Dispensador mural de papel alimentario

Food paper wall dispenser
 Dispensateur mural de papier alimentaire

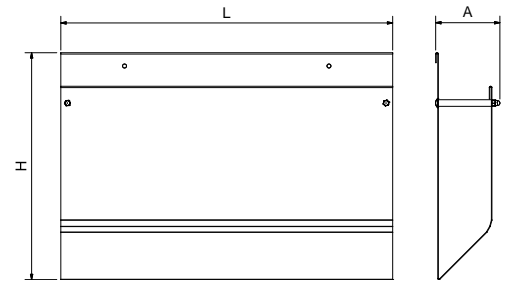

L	A	H	Kg	Barcode	€
500	85	342	2,33	080410	72,00

Dispensador de bolsas para envasado de alimentos

Bag dispenser for food packaging
 Distributeur de sacs pour emballage alimentaire

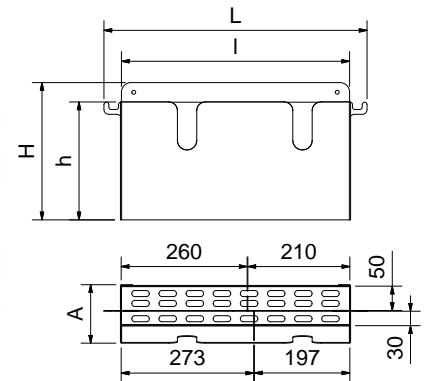

L	l	A	H	h	Kg	Barcode	€
543	471	121	283	243	5,26	080417	108,00

Papelera-dispensador de bolsas de papel

Wastepaper bin and paper bags dispenser
 Corbeille a papiers et distributeur de sacs en papier

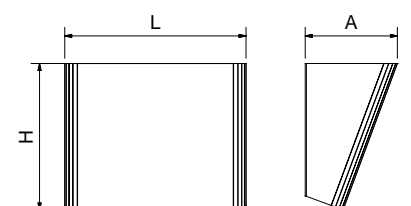

L	A	H	Kg	Barcode	€
315	160	245	1,72	080424	64,00

Portarrollos dispensador de film para envolver

Roll holder dispenser for food wrapping

Porte rouleaux dévidoir pour envelopper les aliments



Características:

Construidos en acero inoxidable. Válido para colocarse de las tres maneras al lado representadas. Provisto de filo dentado especial para favorecer el corte del film o papel de aluminio.

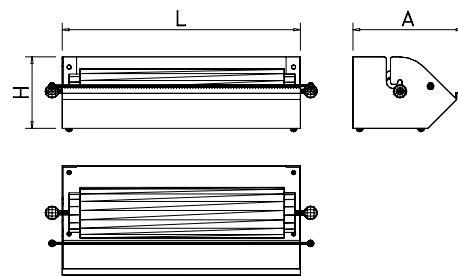

Characteristics:

Made of stainless steel, apt for positioning in the three manners demonstrated besides, equipped with a special serrated blade for cutting plastic film or aluminium foil.

Caractéristiques:

Fabriqués en acier inoxydable, pouvant être placés suivant les trois manières indiquées à côté, munis d'une lame à dents spéciales pour faciliter la coupe du film ou du papier d'aluminium.

L	A	H	Largo de bobina Roll length Longeur du rouleaux	Kg	Barcode	€
350	165	110	300	0,95	080202	60,00
500	165	110	450	1,35	080204	66,00

Kits de portarrollos de papel o film

Wall mounted dispenser for rolls of food wrapping plastic

Kit de porte-rouleaux du papier ou film

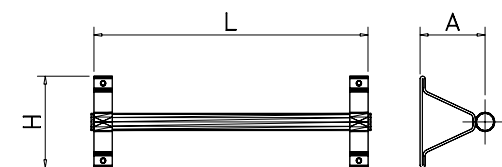

L	A	H	Largo de bobina Roll length Longeur du rouleaux	Kg	Barcode	€
450	150	200	300	2,1	080206	185,00
600	150	200	450	2,2	080208	190,00
750	150	200	600	2,3	080210	200,00
1.050	150	200	900	2,6	080212	220,00

Kits de portarrollos de papel o film serie Eco

Eco serie paper or film roll holder kit

Kit de porte-rouleaux du papier ou film serie Eco

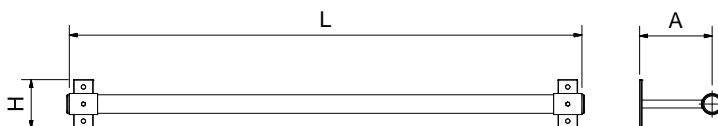

L	A	H	Largo de bobina Roll length Longeur du rouleaux	Kg	Barcode	€
450	150	100	300	1,39	080220	129,00
600	150	100	450	1,59	080222	134,00
750	150	100	600	1,80	080224	137,00
1.050	150	100	900	2,21	080226	141,00

Kit portarrollos insonorizado para papel o film

Soundproof roll holder kit for paper or film

Kit porte-rouleau insonorisé pour papier ou film

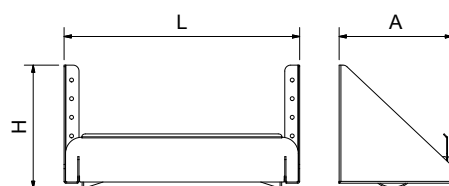

L	A	H	Largo de bobina Roll length Longeur du rouleaux	Kg	Barcode	€
390	190	207	300	1,83	080230	88,00
525	190	207	450	1,89	080232	97,00
690	190	207	600	1,97	080234	106,00
990	190	207	900	2,11	080236	117,00

Dispensador de tissues, guantes, toallas, etc.

Tissues, towels, gloves dispenser

Dispensateur de tissus, essuie-mains, gants, etc.



Para cajas de medidas
Admisse box of dimensions
Dimensions

L	A	H
120	70	230

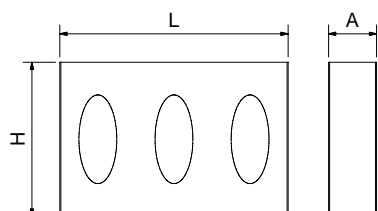

L	A	H	👤	Kg	📊	€
130	80	260	1	0,9	080418	15,00
386	80	260	3	2,1	080420	25,00

Dispensador de mascarillas FFP2

FFP2 mask dispenser

Distributeur de masques FFP2



Novedad
en
nuevas

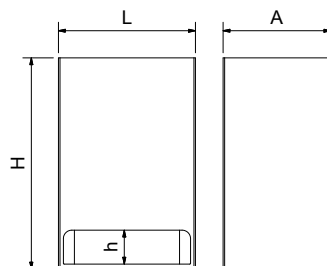

L	A	H	h	Gr	📊	€
162	127	249	40	800	080419	13,50

Consumibles para dispensadores

Disposable spares for dispensers

Accessoires de rechange pour dispensateurs

Talla Size Taille	Uds Units Units	📊	€
-------------------------	-----------------------	---	---



Bolsas colgantes 350x450
Hanging bags 350x450 mm
Sacs pendants 350x450 mm

500 480050 **15,00**



Caja de 10.000 guantes desechables (100 bolsas de 100 unidades)
Box of 10,000 disposable gloves (100 bags of 100 units)
Boîte de 10000 gants jetables (100 sacs de 100 unités)

Única 10000 480054 **60,00**

Barra de apoyo mural para lavabo

Wall-side support bar for washbasin
Barre d'appui murale pour lavabo

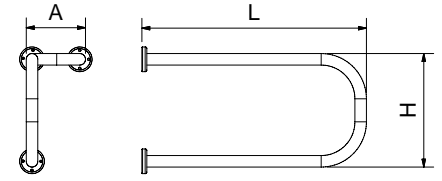

L	A	H	Kg	Barcode	€
600	185	215	1,5	481654	79,00

Barra de apoyo mural para bañera

Wall-side support bar for bath
Barre d'appui murale pour baignoire

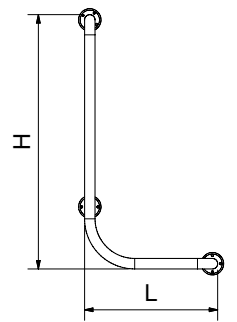

L	H	Kg	Barcode	€
400	800	1,33	481658	70,00

Barra de apoyo recta

Grab bar
Barre d'appui droit

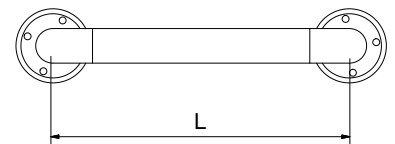

L	Gr	Barcode	€
300	450	481660	25,00
600	600	481662	30,00
900	900	481664	35,00

Barra de apoyo mural vertical abatible

Vertical wall-side hinged support bar
Barre d'appui murale verticale battante

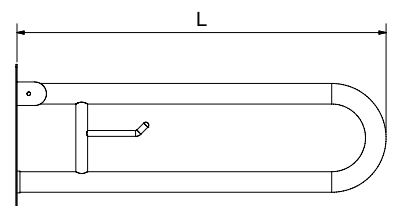

L	Kg	Barcode	€
600	2,35	481666	57,00



Barra de apoyo abatible. Anclaje a suelo
 Floor-mounted hinged support bar
 Barre d'appui battante ancrage au sol

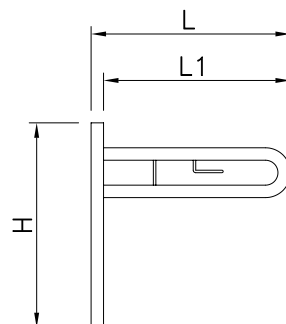

L	H	L1	Kg	Barcode	€
760	740	710	2,90	481670	120,00

Barra de apoyo mural horizontal
 Horizontal wall-side support bar
 Barre d'appui murale horizontale

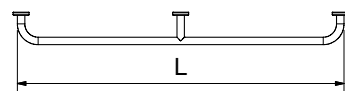

L	Kg	Barcode	€
1.050	1,66	481650	55,00

Barra de apoyo mural horizontal pasamanos
 Horizontal wall-side handrail support bar
 Barre d'appui murale horizontale main courante

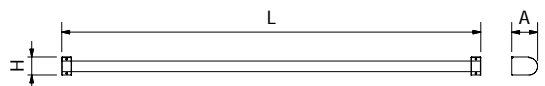

L	A	H	Kg	Barcode	€
2.000	93	65	3,75	083202	79,00

Asiento abatible
 Hinged seat
 Siège abattable

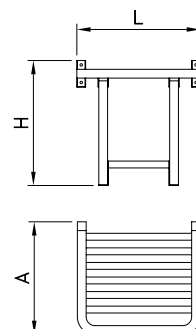

L	A	H	Kg	Barcode	€
460	440	25	3,20	481672	110,00

Lavaojos mural de emergencia en acero inoxidable

Stainless steel wall-mounted emergency eyes-bath
Lave-yeux mural d'urgence en acier inoxydable



Características:

Los lavaojos de emergencia ofrecen instantáneamente agua como primera ayuda.

Los lavaojos con dos rociadores y recogedor en ACERO INOXIDABLE, ofrecen un gran caudal de agua aireada a baja presión, que baña la cara y los ojos, sin dañar los delicados tejidos oculares.

Characteristics:

Our emergency eyes baths offers you an instantly first aid of water.

Our eye baths, with twin sprayer and stainless steel bowl provide a high flow of low pressure aired water that washes face and eyes without any damage for the delicate eyes tissue.

Caractéristiques:

Nos lave-yeux muraux d'urgence vous offre une aide instantané d'eau.

Nos lave-yeux, avec deux têtes d'aspersion et avec vasque en acier inoxydable, procurent un grand débit d'eau aérée à basse pression pour le lavage des yeux et du visage sans endommager les sensibles tissus oculaires.



Con cada aparato, se entrega un rótulo para señalar la unidad.

Every appliance is delivered with a label to mark the unit.
Chaque appareil c'est fourni avec une étiquette pour marquer l'unité.

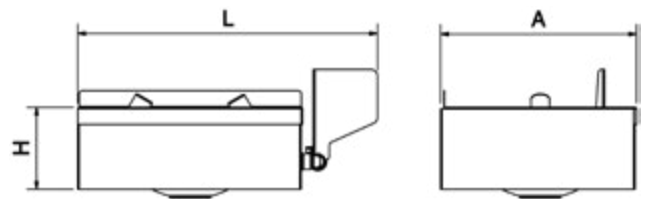

L	A	H	Kg	Barcode	€
469	305	127	5,0	064620	414,00

Ducha mural de emergencia

Wall-mounted emergency shower
Douche d'urgence murale



Con cada aparato, se entrega un rótulo para señalar la unidad.

Every appliance is delivered with a label to mark the unit.
Chaque appareil c'est fourni avec une étiquette pour marquer l'unité.

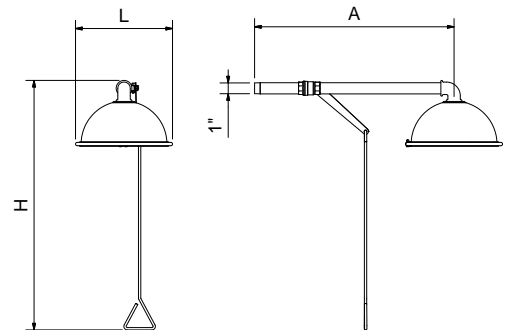

L	A	H	Kg	Barcode	€
294	605	756	2,6	064630	253,00

Lavabotas manual en acero inoxidable

Manual stainless steel boot washer
Lave-bottes manuel en acier inoxydable

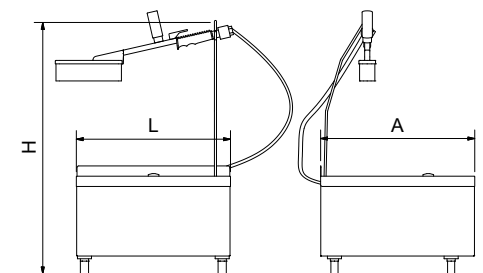

L	A	H	Kg	Barcode	€
450	450	740	7,50	064802	399,00



Armario botiquín
 Medicine chest
 Armoire à pharmacie

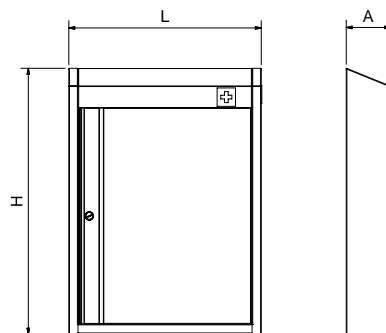

L	A	H	Kg	Barcode	€
523	120	723	9,00	080830	360,00

Indicador de suelo mojado
 Display wet floor
 Affiche sol humide

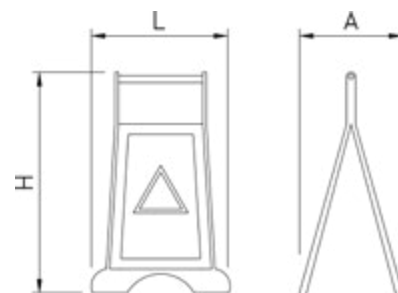

L	A	H	Gr	Barcode	€
420	300	620	400	465622	15,00

Cinta antideslizante adhesiva amarillo/negro
 Yellow/black adhesive non-slip tape
 Ruban adhésif antidérapant jaune/noir



L	A	Gr	Barcode	€
18000	50	670	465624	40,00

Carro de limpieza
 Cleaning cart
 Panier à nettoyage

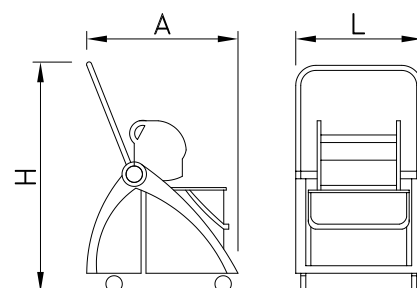

L	A	H	Kg	Barcode	€
440	850	700	9,70	465620	145,00

Carro de limpieza multifunción con bolsa, plataforma y 3 bandejas

Multifunction cleaning trolley with bag, platform and 3 shelves

Chariot de nettoyage multifonction avec sac, plate-forme et 3 plateaux

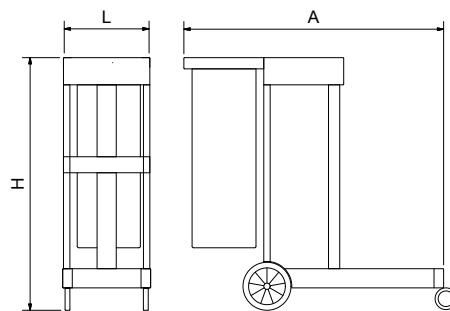

L	A	H	Kg	Barcode	€
510	980	1135	14,10	465618	190,00

Espátula plástica, metal detectable

Plastic spatula, metal detectable

Spatule plastique, métal détectable, rouge

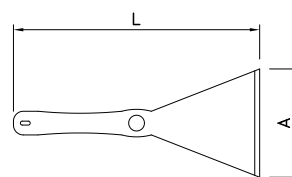

L	A	Gr	Barcode	€
250	110	110	482024	17,00

Escoba haragán para empujar agua, con mango ergonómico

Floor squeegee to remove water, with ergonomic handle

Balai pour pousser l'eau, avec manche ergonomique

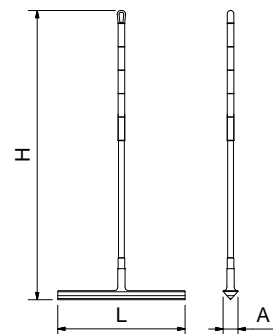

L	A	H	Kg	Barcode	€
700	45	1.590	1,03	482002	40,00

Cepillo + palo polipropileno alimentario

Broom and stick in polypropylene for food use

Balai et manche en polypropylène pour usage alimentaire

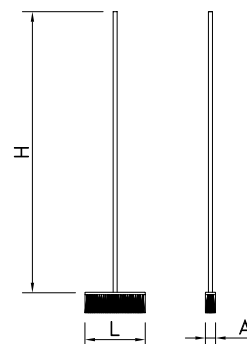

L	A	H	Gr	Barcode	€
300	50	1.500	250	482020	40,00

Cepillo de mano multiusos metal detectable

Multipurpose handheld brush, metal detectable
Brosse à main multi usage métal détectable

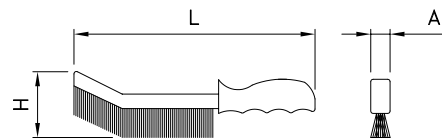

L	A	H	Gr	Barcode	€
410	55	60	270	482022	46,00

Juego de 4 esponjas de colores

4 piece sponge set - different colors
Set de 4 éponges de couleurs

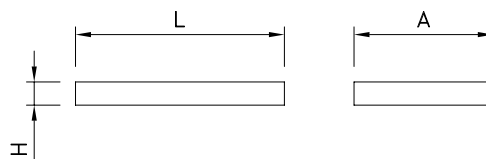

L	A	H	Gr	Barcode	€
135	90	15	48	482026	6,00

Recogedor de mano inox

Long handle stainless dustpan
Peel inoxydable avec manche

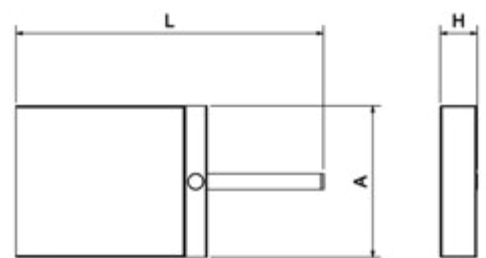

L	A	H	Gr	Barcode	€
390	192	47	600	084404	36,00

Recogedor inox

Stainless steel dustpan
Peel inoxydable

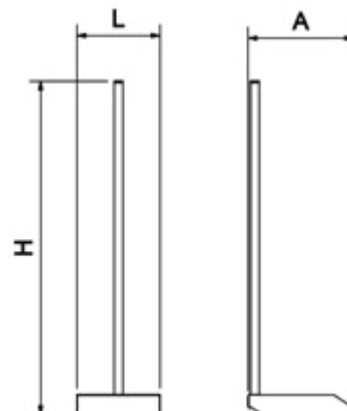

L	A	H	Kg	Barcode	€
244	192	770	1,0	084402	42,00

Recogedor con palo metálico

Dustpan with metal handle
Pelle avec manche métallique

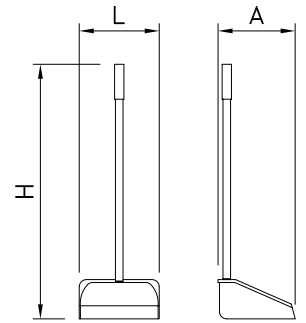

L	A	H	Gr	Barcode	€
275	265	875	250	482006	4,00

Fregona profesional con tiras de microfibra y casquillo Pro

Professional mop with microfiber strips and Pro cap
Vadrouille professionnelle avec bandes en microfibre et capuchon Pro



D	H	Color	Gr	Barcode	€
320	110	Green	195	482038	6,00
		Red		482040	
		Purple		482042	
		Blue		482044	
		Yellow		482046	
		Orange		482048	

Cubo plástico con asa metálica para fregar

Plastic cleaning bucket, metal handle
Seau de ménage avec poignée métallique

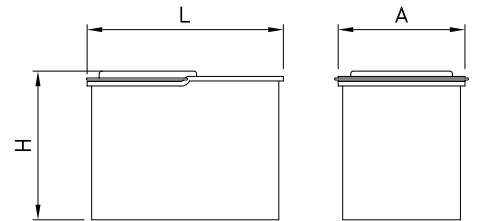

L	A	H	Gr	Barcode	€	
380	280	290	15	600	465626	10,00

Cubo industrial asa de acero inoxidable

Industrial bucket in stainless steel
Seau industriel en acier inoxydable



Características:
Material: HDPE.

Characteristics:
Material: HDPE.

Caractéristiques:
Matériel: HDPE.

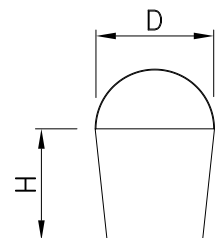

D	H	Gr	Barcode	€	
300	280	13	815	474462	25,00

Cubo de acero inoxidable con tapa 15L serie GO
 GO series 15L stainless steel bucket with lid
 Seau inox 15L série GO avec couvercle

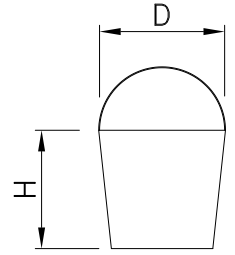

D	H	h	Kg	Barcode	€
340	308	15	1,4	474488	19,00

Cubos premium de acero inox
 Premium stainless steel bucket
 Seaux premium en acier inoxydable

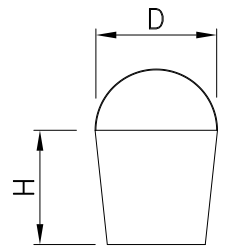

H	D	h	Gr	Barcode	€
288	300	10 lts.	2.200	474492	53,00
370	325	15 lts.	3.000	474496	63,00
	295	10 lts.	500	474494	18,00
	320	15 lts.	650	474498	21,00

Barreños
 Plastic basin for food use
 Baquets ronds aliments

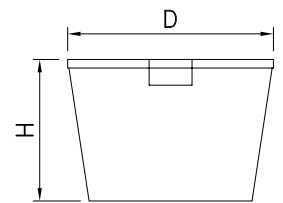

D	H	h	Gr	Barcode	€
390	410	35	990	483050	19,00
460	470	50	1.500	483054	25,00

Tapa para barreños
 Lid for plastic basin for food use
 Couvercle pour bassine

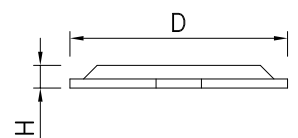

D	H	Gr	Barcode	€
390	50	560	483056	8,00
460	50	600	483058	10,00

Urinarios inox
Inox urinals
Urinoir inox



Características:

Urinarios individuales y colectivos, para fijación mural, en acero inoxidable.

Entrada de agua superior de 3/8" conectada a tubo con reparto de descarga por toda la superficie del urinario.

Cubeta con desagüe central, diámetro de salida 1 y 1/2".

Incluye kit de fijación y un filtro aromatizante, color azul.

Characteristics:

Single and collective urinals, for wall mounting, stainless steel.

Upper water inlet 3/8" connected with discharge distribution across the surface of the urinal. Tank fitted with central drain, outlet diameter 1 1/2"

Mounting kit and blue scented filter included.

Caractéristiques:

Urinoirs individuels et collectifs, pour montage mural, en acier inoxydable.

Entrée d'eau supérieure 3/8" relié au tube de distribution pour décharge en long de la surface de l'urinoir. Muni de drain, diamètre de sortie de 1 1/2"

Kit de montage et filtre bleu parfumée inclus.

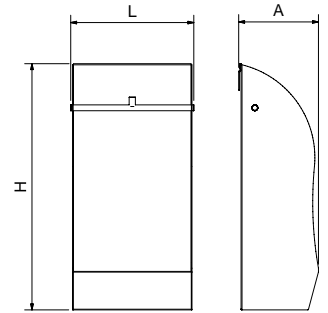
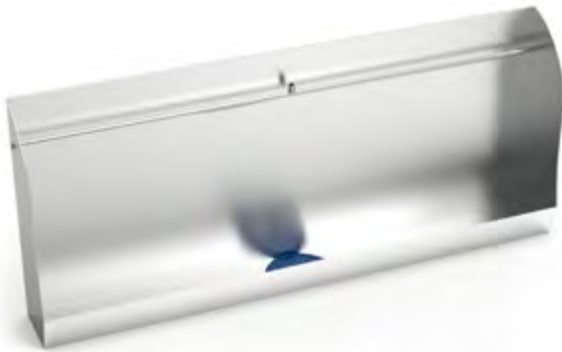

No incluye válvulas de agua.
Water valves not included.
Robineets d'eau non inclus.



Ver pág. 235.
See p. 235.
Voir p. 235.

L	A	H	Kg	Barcode	€
335	217	670	7,00	065002	443,00
1.575	217	670	22,00	065004	661,00



WC inox
Inox WC pan
Cuvette WC inox



€



456022 74,00

Tapa
Toilet lids
Toilette couvercle

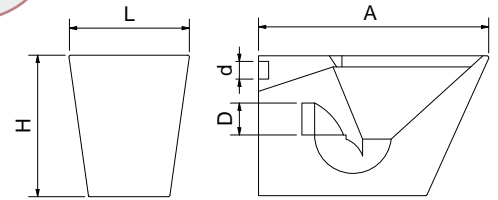
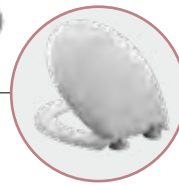

	L	A	H	D	d	Kg	Barcode	€
	355	640	390	100	60	7,89	456018	1.049,00
	370	800	460	100	60	6,90	456020	1.049,00

Taza turca inox
Inox squat toilet
Toilette turque inox

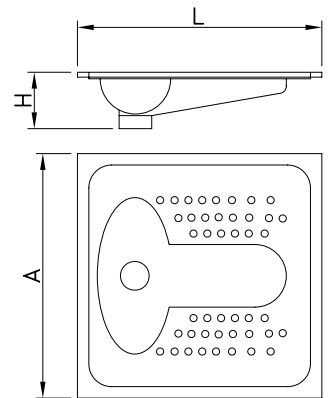

L	A	H	Kg	Barcode	€
750	750	133	6,27	456010	276,00

Estación de higiene para wc con dispensador de papel y escobillero en acero inoxidable
Hygiene station for toilet, with roll holder and brush in stainless steel
Station d'hygiène WC avec distributeur de papier et porte-brosse en acier inoxydable



Novedad
NEW
PRODUCT

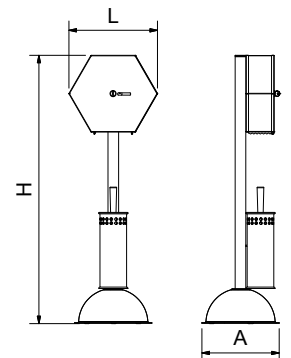

L	A	H	Kg	Barcode	€
332	290	1.005	10,00	062010	207,00

Set de cepillo y soporte inoxidable para baño

Brush and holder set for toilet
Brosse et support inoxydable pour bains

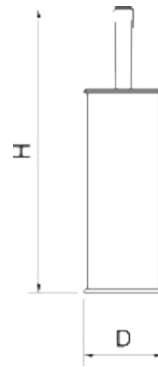

Incluye fijación a pared.
Includes wall fixing.
Comprend fixation murale.

H	D	Gr	Barcode	€
370	85	565	460240	13,00

Plato ducha inox

Inox shower tray
Plateaux douche inox

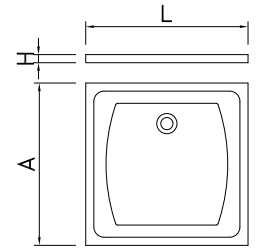

L	A	H	Kg	Barcode	€
750	750	40	5,50	456002	294,50
800	800	40	5,70	456004	287,00

Estante jabonera inox

Stainless steel soap dish
Porte-savon en acier inoxydable

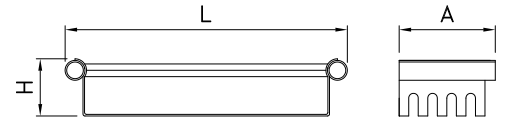

L	A	H	Gr	Barcode	€
350	121	70	170	460270	39,00

Toallero

Towel bar
Barre porte serviette

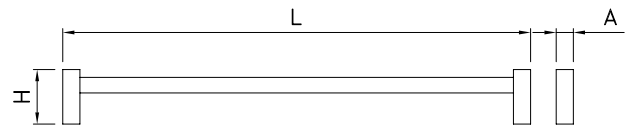

L	A	H	Gr	Barcode	€
600	55	50	200	460274	27,00

Portarrollos papel higiénico

Toilet paper roll dispenser
Distributeur papier hygiénique

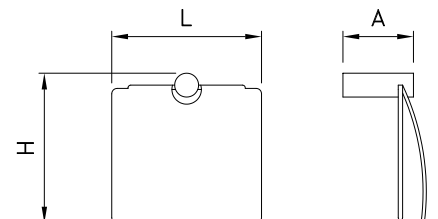

L	A	H	Gr	Barcode	€
102	55	115	160	460272	20,00



Portarollos papel higiénico con repisa
 Toilet roll holder with shelf
 Porte-rouleau de papier toilette avec étagère

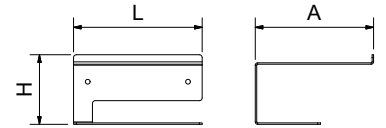

L	A	H	Gr	Barcode	€
136	125	74	330	062004	11,00

Perchero individual
 Individual hanger
 Patère individuel

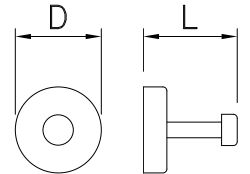

L	D	Gr	Barcode	€
55	50	70	460276	14,00

Tendedero retráctil
 Retractable hanger
 Fil à linge retractable

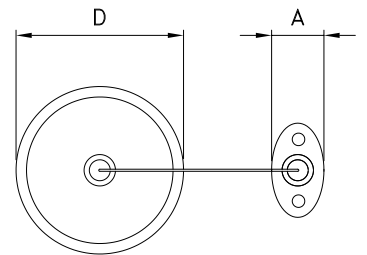

A	D	↔	Gr	Barcode	€
55	90	2,2 mts	140	481450	18,00

Espejo antivandálico acero inoxidable
 Tamper proof mirror in stainless steel
 Miroir en acier inoxydable anti-vandalisme

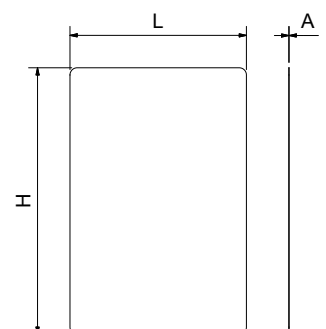

L	A	H	Kg	Barcode	€
490	1	740	2,90	062020	55,00

Cambiador de pañales horizontal plegable

Fold-down baby changing unit
Table pliante à langer horizontale



Características:

Amplio cambiador de bebés plegable antibacteriano de fijación mural, ideal para instalar en aseos públicos, centros comerciales y grandes superficies, establecimientos sanitarios, restaurantes, etc. Incorpora un gancho para que los usuarios puedan colgar bolsas o cualquier elemento necesario, así como cinturón de seguridad ajustable para el bebé.

Su sistema hidráulico especial posibilita que la tapa permanezca cerrada para ahorrar espacio cuando no esté en uso.

Characteristics:

Large fold-down antibacterial wall-mounted baby changing unit, ideal to be installed in public toilets, malls and department stores, health facilities, restaurants, etc.

It is fitted with a hook so that users can hang bags or any necessary item, as well as an adjustable safety belt for the baby.

Its special hydraulic system allows the lid to remain closed to save space when not in use.

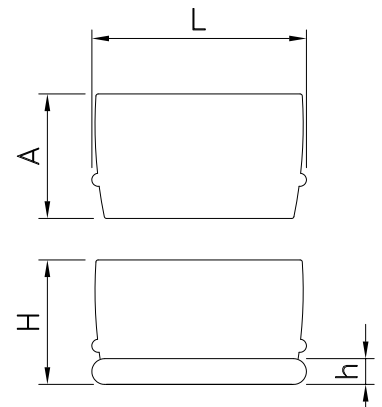

Caractéristiques:

Grande table à langer murale pliante antibactérienne, idéale pour une installation dans les toilettes publiques, les centres commerciaux et les grandes surfaces, les établissements de santé, les restaurants, etc.

Il intègre un crochet pour que les utilisateurs puissent accrocher des sacs ou tout objet nécessaire, ainsi qu'une ceinture de sécurité réglable pour le bébé.

Son système hydraulique spécial permet au couvercle de rester fermé pour économiser de l'espace lorsqu'il n'est pas utilisé.

L	A	H	h	Kg	Barcode	€
860	500	590	80	9,80	460256	270,00

Puesto de lavado y desinfección

Sanitising and disinfectant spray system
Poste de lavage et de désinfection



Características:

Soporte inox. para 1 garrafa de 5 litros.

Characteristics:

Inox holder for 5 litres tank

Caractéristiques:

Support inox pour réservoir de 5 litres

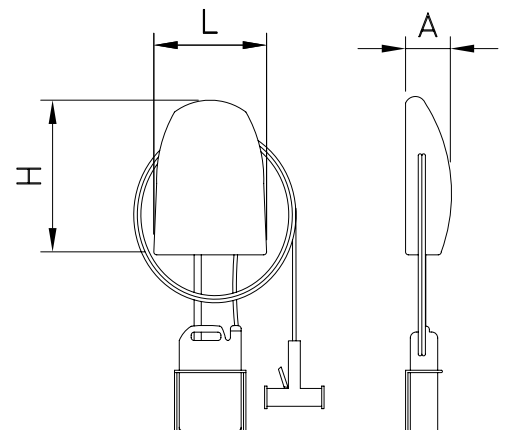

Longitud de manguera: 15 mts.
Hose length: 15 mts.
Longueur du tuyau: 15 mts.

L	A	H	Kg	Barcode	€
350	120	480	2,6	465602	550,00

Columna inox de desinfección para gel hidroalcohólico

Stainless steel disinfection column for hydroalcoholic gel

Colonne de désinfection en acier inoxydable pour gel hydroalcoolique

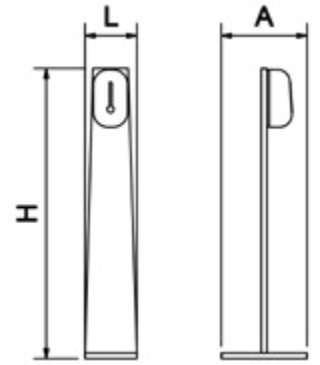

L	A	H	Kg	Barcode	€
212	350	1.190	3,5	064636	90,00

Dispensador de gel hidroalcohólico automático de columna

Automatic hand sanitiser dispensing station

Distributeur automatique de gel hydroalcoolique sur colonne



Funcionamiento a pilas
Batteries functioning
Fonctionnement a piles

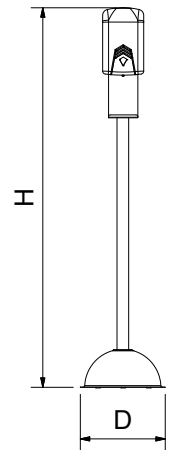

D	H	Kg	Barcode	€
290	1300	9,95	064604	153,00

Columna mixta para guantes y dispensador electrónico de gel hidroalcohólico

Automatic hand sanitiser and gloves dispensing station

Colonne à gants mixtes et distributeur électronique de gel hydroalcoolique



Funcionamiento a pilas
Batteries functioning
Fonctionnement a piles

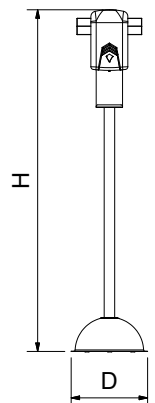

D	H	Kg	Barcode	€
290	1300	10,85	064605	207,00

Columna para botella de gel hidroalcohólico
 Hand sanitiser holder dispensing station
 Colonne pour bouteille de gel hydroalcoolique

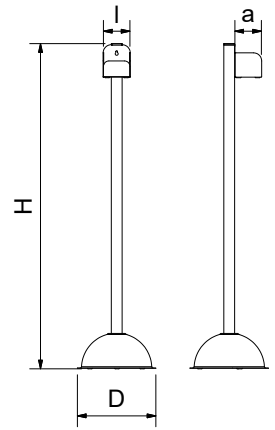

L	H	D	a	Kg	Barcode	€
98	1200	290	98	10,20	064606	110,00

Columna mixta para guantes y botella de gel hidroalcohólico
 Hand sanitiser holder and gloves dispensing station
 Colonne mixte gants mixtes et bouteille de gel hydroalcoolique

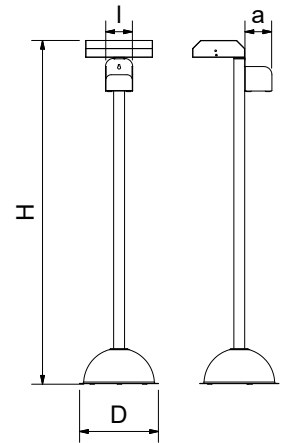

L	H	D	a	Kg	Barcode	€
98	1265	290	98	11,10	064608	160,00

Soporte de sobremesa o mural para botella de gel hidroalcohólico
 Wall-mounted or tabletop hand sanitiser holder
 Support de table ou mural pour bouteille de gel hydroalcoolique

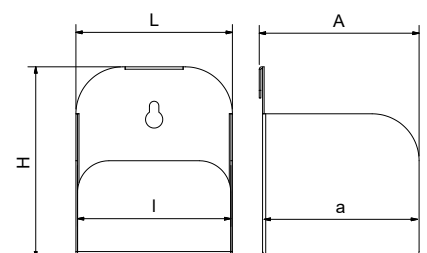

L	l	A	a	H	Kg	Barcode	€
100	98	102	98	122	0,36	264612	16,00





Columna con dosificador de gel hidroalcohólico de funcionamiento a codo

Elbow operated hand sanitiser dispensing station

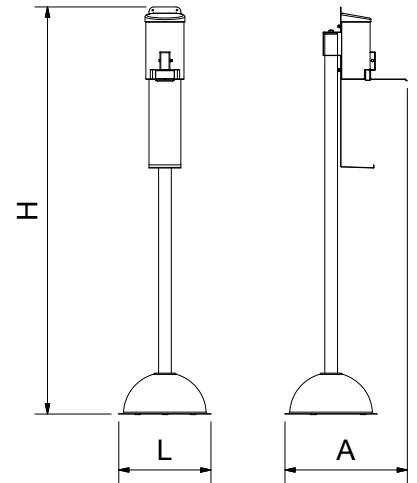
Colonne avec distributeur de gel hydroalcoolique à commande par coude



L	A	H				€
290	430	1.280	1 lts	10,00	064618	155,00

Columna con dispensador de gel hidroalcohólico especial para niños

Automatic hand sanitiser dispensing station, especially for children

Colonne avec distributeur de gel hydroalcooliques pécial pour enfants



Funcionamiento a pilas
Batteries functioning
Fonctionnement a piles

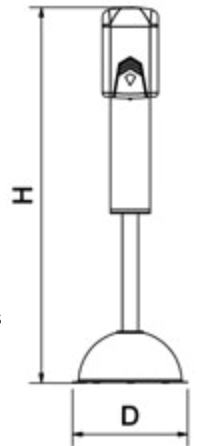



D	H				€
290	950	1 lt	7,00	064632	188,00

Columna para botella de gel hidroalcohólico especial para niños

Hand sanitiser holder dispensing station, especially for children

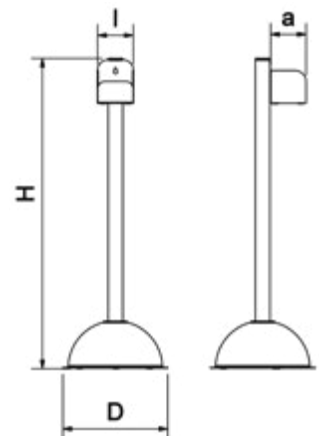
Colonne avec distributeur de gel hydroalcooliques pécial pour enfants



D	H	l	a			€
290	855	98	98	4,00	064634	138,00

Accesorios para columnas de gel

Accessories for hand sanitiser dispensing stations
Accessoires pour colonnes de gel



064628 100,00

Termómetro infrarrojo con adaptador para columna
Infrared thermometer with column adaptor
Thermomètre infrarouge avec adaptateur pour colonne



080610 81,00

Papelera acoplada
Docked / fixed wastebasket
Poubelle pour accoupler



064612 45,00

Dispensador de papel mecha acoplado a columna
Wick paper dispenser attached to Centerfeed paper
Distributeur de papier cheminé fixé à la colonne



064614 14,00

Emplazamiento publicitario opcional para columna
Optional advertising spot
Placement publicitaire en option pour la colonne



Dispensador de gel hidroalcohólico de gran capacidad a pedal

Pedal operated large capacity hand sanitiser dispensing station
Distributeur de gel hydroalcoolique haute capacité à pédale

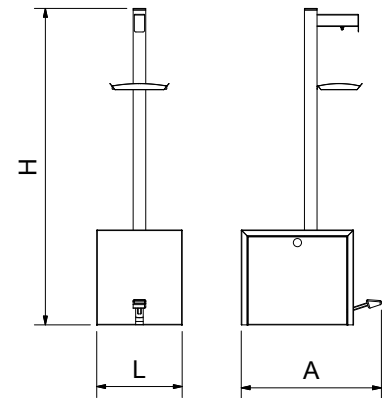

L	A	H	kg	Barcode	€
272	445	1006	5 lts	9,00	064622 374,00

Dispensador de gel hidroalcohólico automático en acero inox

Automatic hand sanitiser dispenser
Distributeur automatique de gel hydroalcoolique en acier inox



Características:

Construcción en acero inoxidable.
Sensor infrarrojo de aplicación.
Fácil instalación.
Limpio, robusto y duradero.

La operación se realiza sin contacto evitando la contaminación cruzada de patógenos. Al colocar las manos debajo, expulsa una dosis de solución alcohólica evaporable.

Lugares de instalación: hospitales, clínicas, fábricas de productos alimenticios, comedores colectivos, aeropuertos, restaurantes, etc...

4 baterías AA de 1,5 V.
Capacidad 1 litro.
500 pulverizaciones.
Instalación mural.

Characteristics:

Wholly made of stainless steel.
Infrared sensor controlled.
Easy installation and maintenance.
Robust and lasting.

Touch-free operation to avoid pathogen cross-contamination: when placing your hands underneath, it ejects a dose of evaporable alcoholic solution.

Suitable for hospitals, food manufacturing plants, collective dining, airports, restaurants, etc...

4 batteries AA - 1,5 V.
Capacity of liquid container: 1.000 ml.
500 doses.
Wall-mounted.

Caractéristiques:

Entièrement en acier inoxydable.
Fonctionnement par senseur infrarouge.
Facilité d'installation et d'entretien.
Robuste et durable.

Désinfectez vos mains sans contact pour éviter la contamination croisée des agents pathogènes. Lorsque vous placez vos mains en dessous, il est éjecté une dose de solution évaporable alcoolique.

Convient pour les hôpitaux, les usines alimentaires, restauration collective, les aéroports, restaurants, etc...

4 piles AA - 1,5 V.
Capacité du réservoir de liquide: 1.000 ml.
500 doses.
Fixation murale.

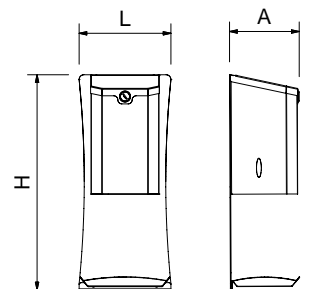

L	A	H	kg	Barcode	€
192	145	450	2,6	064602	98,00

Dosificador de jabón

Soap dispenser
Doseur de savon

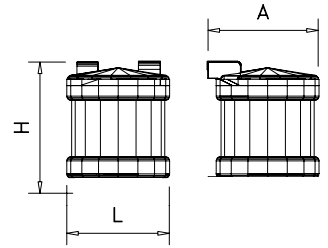

L	A	H		Gr		€
120	120	170	1 lts	270	460202	10,00

Dosificador de jabón

Soap dispenser
Doseur de savon



Características:

La tapa y el pulsador, por su diseño, no permite el apoyo de cigarrillos manteniendo un aspecto inmejorable. La estructura del vaso no permite que penetren impurezas en el conjunto pulsador, prolongando la vida del dispensador.

Characteristics:

The cover and the push-button, for their design, do not allow the support of cigarettes, maintaining an excellent aspect. The structure of the vase does not allow the penetration of impurities, prolonging the length of the dispenser.

Caractéristiques:

La couverture et le bouton-poussoir, par son desine, ne permettent pas l'appui des cigarettes et maintiennent un aspect excellent. La structure du vase ne permette pas que pénétrant impuretés dans le conjoint poussoir, prolongant ainsi la durée du dispensateur.

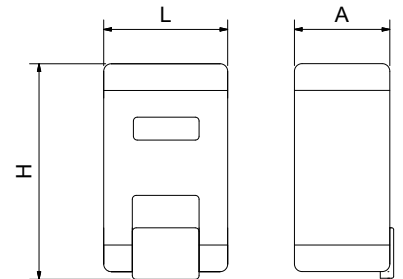

L	A	H		Gr		€
112	105	210	1 lts	356	460204	19,00

Dosificador de jabón modelo Nube

Soap dispenser, Cloud model
Distributeur de savon modèle Nuage

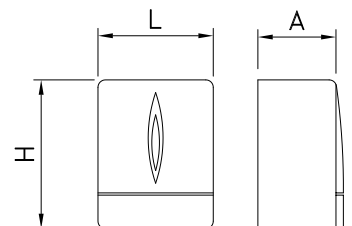

L	A	H		Gr		€
155	115	201	544	460282	22,00	

Dosificador de gel-espuma

Foam gel dispenser
Doseur pour gel à mousse

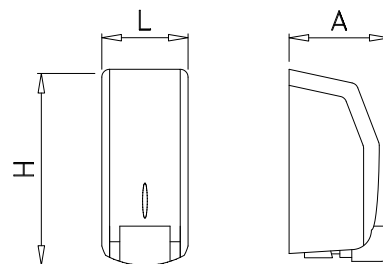

L	A	H				€
110	105	205	0,7 lts	500	460222	19,00

Jabonera electrónica (funcionamiento a pilas)

Hands-free soap dispenser (battery working)
Doseur de savon automatique (à piles)



4 baterías AA de 1,5 V.
4 batteries AA - 1,5 V.
4 piles AA - 1,5 V.

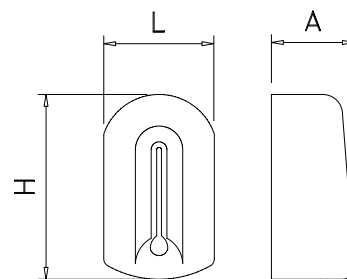

L	A	H				€
140	105	235	1 lts	525	460236	39,00

Dosificador automático de gel hidroalcohólico con soporte de sobremesa

Hands-free dispenser of hydroalcoholic gel worktop support
Distributeur automatique de gel hydroalcoolique avec support sur table



4 pilas tipo C
4 Type C batteries
4 piles type C

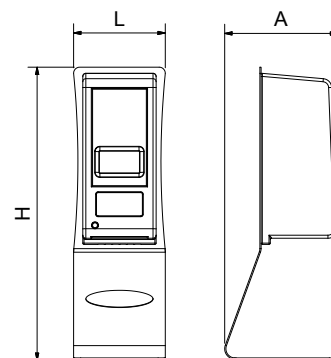

L	A	H				€
150	185	480	1 lts	2,00	064626	112,00

Dosificador de jabón inox

Stainless steel soap dispenser
Doseur de savon en acier inoxydable

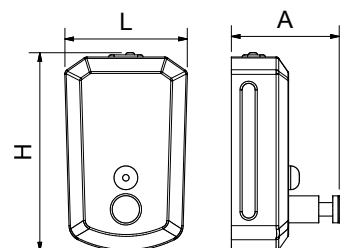

L	A	H				€
122	66	202	1,2 lts	900	460220	29,00

Dosificador de jabón inox encastrable

Stainless steel soap dispenser to be embedded
Doseur de savon en acier inoxydable pour adosser

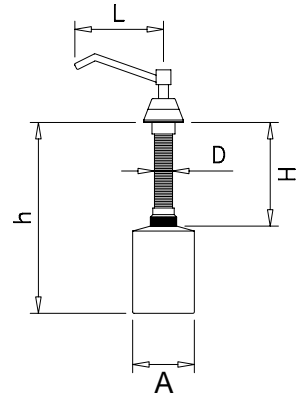

L	A	H	h	D				€
105	75	132	240	22	500 ml	580	460218	45,00

Secamanos inox con pulsador y tobera

Stainless push-button operated hand dryer with nozzle
Sèche-mains inox avec poussoir et tuyère

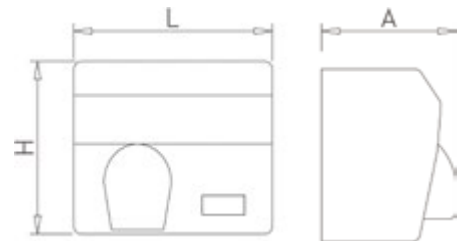

L	A	H		Tensión Voltage Tension	Frecuencia Frequency Frequence	Potencia Power Puissance			€
260	207	235	30	220-240 V	50/60 Hz	2300 W	6,30	460290	175,00

Secamanos óptico inox satinado con tobera

Stainless satiny optic hand dryer with nozzle
Sèche-mains optique inoxydable satiné avec tuyère

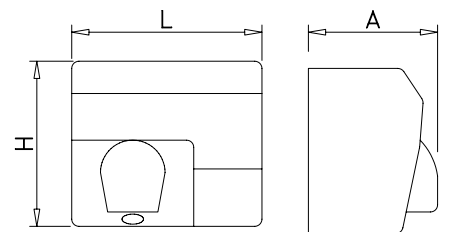

L	A	H		Tensión Voltage Tension	Frecuencia Frequency Frequence	Potencia Power Puissance			€
275	200	230	30	220 V	50Hz	2300 W	4,60	460228	185,00

Secamanos óptico inox satinado sin tobera

Stainless satiny optic hand dryer without nozzle
Sèche-mains optique inoxydable satiné sans tuyère

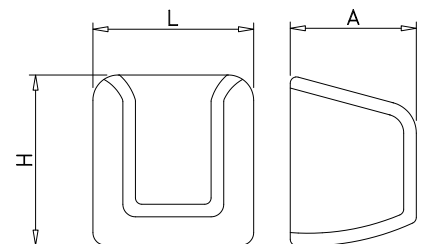





L	A	H		Tensión Voltage Tension	Frecuencia Frequency Frequence	Potencia Power Puissance			€
290	175	323	100	220 V	50 Hz	1.200 W	3,16	460226	178,00

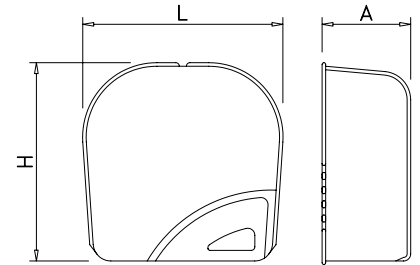

Secamanos óptico en ABS

ABS optic hand dryer
Sèche mains optique ABS





L	A	H	 m/s	Tensión Voltage Tension	Frecuencia Frequency Frequence	Potencia Power Puissance			€
275	127	250	10	230 V	50 Hz	1.750 W	2,7	460206	120,00

Secamanos óptico en ABS sin tobera modelo Nube

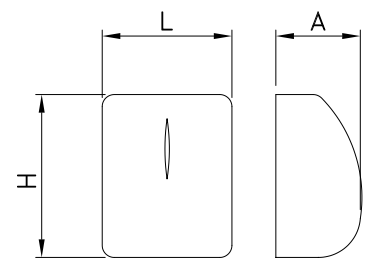
ABS automatic hand dryer without nozzle, Cloud model
Sèche-mains optique ABS sans tuyère modèle Nuage



L	A	H	 m/s	Tensión Voltage Tension	Frecuencia Frequency Frequence	Potencia Power Puissance			€
215	140	270	25	230 V	50 Hz	1.800 W	1,3	460286	163,00

Secamanos inox de bajo consumo

Stainless steel low consumption hand dryer
Sèche mains inox consommation bas



Características:

Seca las manos mediante aire comprimido a alta velocidad.

Sin resistencia eléctrica, consigue calentar el aire mediante el aprovechamiento de la potencia del motor, reduciendo al máximo el consumo eléctrico.

Characteristics:

Dries hands with a high flow of compressed air.



Without electrical resistance, the air gets heated by using the power of the engine, minimizing the electricity consumption.

Caractéristiques:

Séchage de mains avec air comprimé à fort débit.

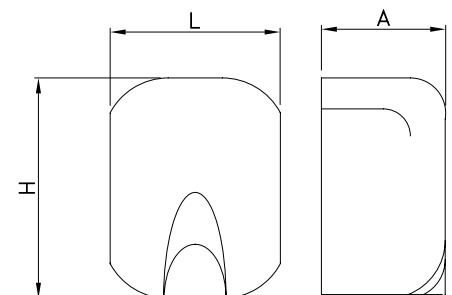
Sans résistance électrique, l'air est chauffé à l'aide de la puissance du moteur, réduisant la consommation d'électricité.



L	A	H	 m/s	Tensión Voltage Tension	Frecuencia Frequency Frequence	Potencia Power Puissance			€
221	157	285	76	220/240 V	50/60 Hz	550 W	3,0	460250	390,00

Secamanos ultrarápido

Ultra-fast hand dryer
Sèche-main ultra-rapide



Caractéristiques:
Nouvelle conception ergonomique pour sèche à mains.
Il n'a pas besoin d'une résistance pour chauffer l'air, ce pour cela qu'il économise un 80% la consommation de séchage par rapport aux systèmes papier ou de coton.
Séchage complet ultra-rapide grâce à son double flux d'air comprimé.
Fabriqué en ABS.



Características:

Nuevo concepto de diseño ergonómico para el secado de manos.
Menor consumo energético al no lleva resistencia para calentar el aire, ahorra hasta un 80 % los costes de secado frente a sistemas de papel especial o algodón.
Secado perfecto ultrarrápido gracias a su doble flujo de aire comprimido. Construido en ABS.

Characteristics:

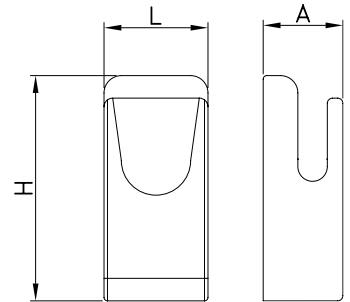
New conception of ergonomic design for hand dryers.
It does not need a resistance for heating air, which means an 80% of drying consumption reduction in comparison with paper or cotton systems.
Ultra-fast and thorough drying, thanks to its double flow of compressed air. Made of ABS.



L	A	H	 m/s	Tensión Voltage Tension	Frecuencia Frequency Frecuency	Potencia Power Puissance	 Kg		€
300	220	687	95	220 V	50 Hz	1.650 W	11,60	460238	700,00

Dispensador de rollos de papel higiénico

Dispenser for rolls of toilet paper
Dévidoirs de rouleaux de papier hygiénique





Tipo de rollo: Bobina de Ø 250 mm. / 300 m.
Ejes: Ø de 25, 45 y 60 mm

Type of roll: Ø 250 mm. / 300 m.
Axes: Ø 25, 45 y 60 mm

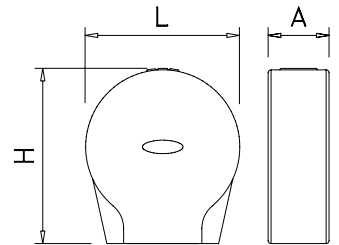
Type de rouleau: Ø 250 mm. / 300 m.
Axes: Ø 25, 45 y 60 mm



L	A	H	 Gr		€
275	120	275	500	460210	17,00

Dispensador de rollos de papel higiénico inoxidable

Stainless steel dispenser for rolls of toilet paper
Dévidoirs de rouleaux de papier hygiénique en acier inoxydable



Tipo de rollo: Bobina de Ø 250 mm. / 300 m.
Ejes: Ø de 38 mm

Type of roll: Ø 250 mm. / 300 m.
Axes: Ø 38 mm.

Type de rouleau: Ø 250 mm. / 300 m.
Axes: Ø 38 mm.

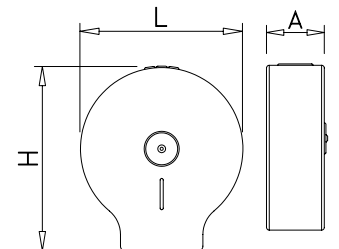

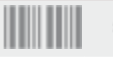
L	A	H	 Kg		€
250	112	260	1,6	460212	25,00

Dispensador de papel higiénico tripe en acero inoxidable

Triple toilet roll holder in stainless steel
Triple distributeur de papier toilette en acier inoxydable

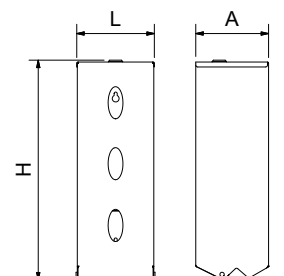

L	A	H	 Kg		€
126	118	356	1,28	062006	69,00

Dispensador inox hexagonal de papel higiénico 400 m

Hexagonal stainless steel toilet roll holder 400 m

Distributeur de papier hygiénique hexagonal en acier inoxydable 400 m



Tipo de rollo: Bobina de Ø 275 mm. / 400 m.

Type of roll: Ø 275 mm. / 400 m.

Type de rouleau: Ø 275 mm. / 400 m.

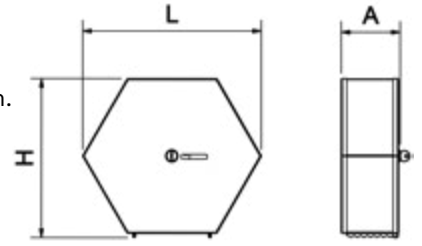

L	A	H	Kg	Barcode	€
335	110	300	1,7	062002	40,00

Dispensador de toallas

Towels dispenser

Dispensateur d'essuie-mains



Características:

El innovador diseño del conjunto llave-cerradura ofrece seguridad al producto, evitando un mal uso del papel. Sus formas redondeadas de mayor resistencia al impacto permiten ofrecer un producto robusto y capaz de adaptarse a cualquier entorno.

Characteristics:

The innovating design of the set key-lock offers security to this product and avoids a wrong usage of the paper. Its rounded shapes of a higher impact resistance let offer a strong product capable to be adapted at any place.

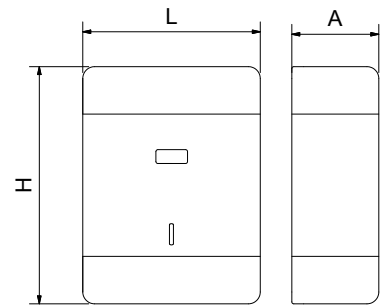

Caractéristiques:

L'innovateur dessin du conjoint clé-fermeture, offre sécurité au produit, en évitant le mal usage du papier. Ses formes arrondies d'une plus grande résistance au impacte permettent offrir un produit robuste et capable pour s'adapter a quelque endroit.

L	A	H	Icon	Kg	Barcode	€
275	130	360	600 servicios	1,1	460214	21,00
Use for 600 applications / 600 applications d'usage						

Dispensador en acero inoxidable de toallas de papel

Stainless steel towel dispenser

Dispensateur en acier inoxydable d'essuie-mains

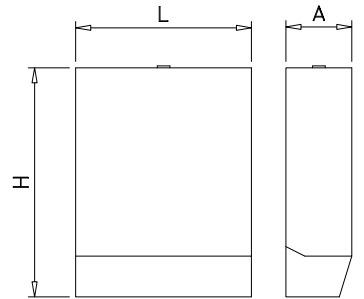

L	A	H	Icon	Kg	Barcode	€
238	115	304	400/600 servicios	1,65	062030	37,00
Use for 400/600 applications / 400/600 applications d'usage						

Dispensador de toallas de papel con autocorte

Paper towel dispenser with auto cutter

Distributeur de serviettes en papier avec coupe automatique

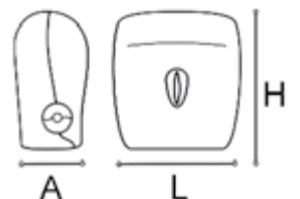

L	A	H	Kg	Barcode	€
280	233	382	2,30	460224	75,00

Dispensador de bolsitas higiénicas

Higienic bags dispenser
Distributeur de sacs hygiéniques

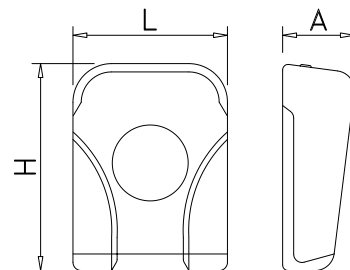

L	A	H	Gr	Barcode	€
120	40	155	130	460258	13,00

Dispensador de papel mini-mecha modelo Nube

Centre feed mini towel dispenser, Cloud model
Distributeur de papier cheminé modèle Nuage

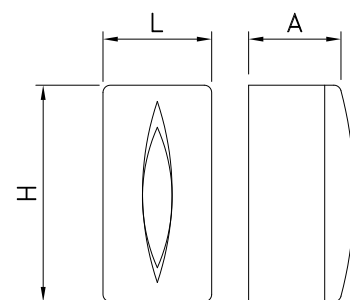

L	A	H	Gr	Barcode	€
147	143	293	170	460280	21,00

Dispensador de papel higiénico modelo Nube

Toilet paper dispenser, Cloud model
Distributeur de papier toilette modèle Nuage

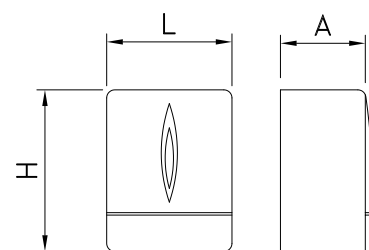

L	A	H	Gr	Barcode	€
276	143	275	765	460284	24,00

Dispensador de toallas modelo Nube

Towel dispenser, Cloud model
Distributeur de papier essuie-mains modèle Nuage

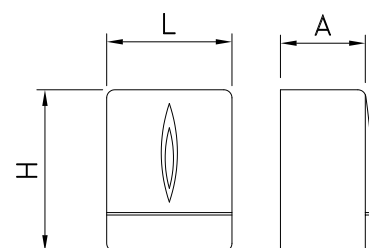

L	A	H	Gr	Barcode	€
308	149	331	1.057	460288	25,00



Dispensador de papel mecha

Centerfeed wick-paper dispenser
Dispensateur de papier-mèche



Características:

Dispensador de papel mecha muy funcional por su tamaño y sencillez. Para todo tipo de papel mecha con o sin precorte.

Characteristics:

Very useful wick-paper dispenser because of its size and simplicity. For all kinds of wick-paper, with or without cut.

Caractéristiques:

Dispensateur de papier-mèche très fonctionel par ses dimensions et simplicité. Pour tous les types de papier-mèche, sans et avec coupure.

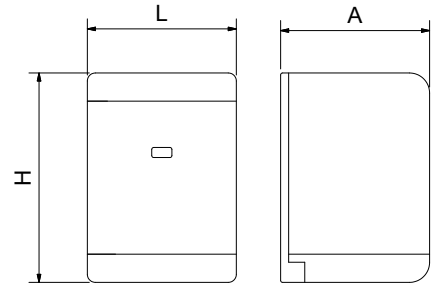

L	A	H	Gr	Barcode	€
220	210	305	790	460216	25,00

Dispensador de papel mecha en acero inox

Stainless steel centerfeed wick-paper dispenser
Dispensateur de papier-mèche en acier inoxydable

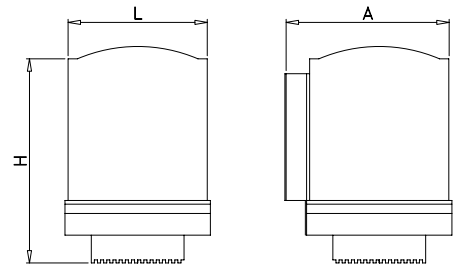

L	A	H	Kg	Barcode	€
250	270	320	3,3	460208	157,00

Dispensador de bobina industrial

Industrial roll dispenser
Distributeur de bobine industrielle

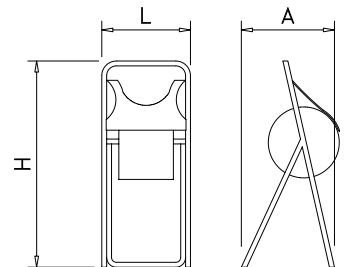

L	A	H	Gr	Barcode	€
400	360	930	225	460262	35,00

Dispensador mural de bobina industrial

Industrial roll wall-dispenser
Distributeur mural de bobine industrielle

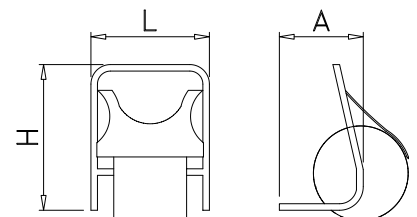

L	A	H	Gr	Barcode	€
390	240	460	100	460264	27,00

Cepillos para limpieza de manos y uñas

Brushes for hands and nails washing
Brosse pour le lavage des mains et ongles



Características:

Los cepillos son desechables y ayudan a prevenir contagios en el lavamanos. El diseño único del cepillo elimina la suciedad y las bacterias de poros, arrugas, uñas y cutículas. Tan sólo utilícelo un día y deséchelo.

Color azul para fácil identificación y seguridad alimentaria.
Canal central para limpieza bajo las uñas.

Characteristics:

The brushes are disposable and help prevent cross-contamination at the hand washing sink. The unique design of the brush effectively removes soil and bacteria from pores, wrinkles, nails and cuticles. Simply use for a day and then throw it away.

Food safe blue colour for easy identification.
Centre channel for cleaning under nails.

Caractéristiques:

Les brosses sont jetables et aident à prévenir des contagés dans le lave-main. Le dessin unique du brosse élimine la saleté et les bactéries des pores, rides, ongles et cuticules. Uniquement utilisez-le un jour et jetez-le.

Couleur bleu pour son facile identification et sécurité alimentaire.
Channel central pour nettoyer dessus les ongles.



Dispensador inox para cepillos de limpieza de manos y uñas

Stainless steel dispenser for hands and nails washing-brusher
Dispensateur inoxydable de brosses à mains et ongles

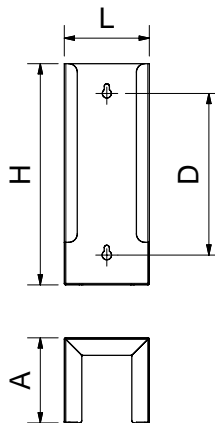

Cepillo limpiauñas de uso personal

Nail brush for personal use
Brosse à ongles pour usage personnel



Características:

Elimina la suciedad y las bacterias de poros, arrugas, uñas y cutículas.

Characteristics:

Remove dirtiness and bacteria from pores, wrinkles, nails and cuticles.

Caractéristiques:

Éliminer saleté et bactéries des pores, rides, ongles et cuticules.

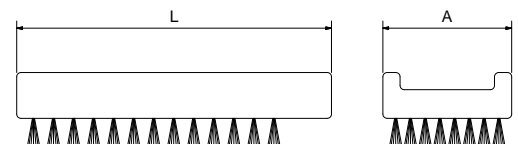

Mampara de protección para colgar
 Hanging protection screen
 Écran de protection pour suspendre

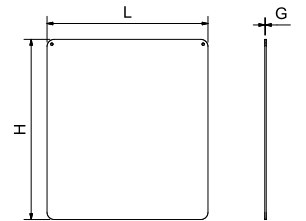

L	G	H	Kg	Barcode	€
670	6	750	4,64	480102	53,00

Mampara de protección de sobremesa
 Desktop protection screen
 Écran de protection sur table

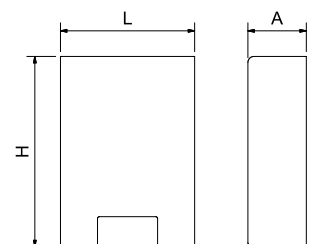

L	A	H	Kg	Barcode	€
670	292	950	10,44	480104	65,00

Dispositivo para abrir puertas anti-contagio
 Anti-contagion opening door device
 Dispositif pour ouvrir des portes anti-contagion

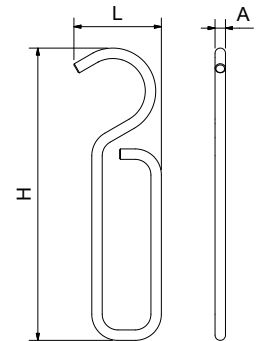

L	A	H	Gr	Barcode	€
50	7	165	80,00	023710	1,00

Felpudo higiénico de caucho
 Rubber sanitary mat
 Tapis hygiénique en caoutchouc

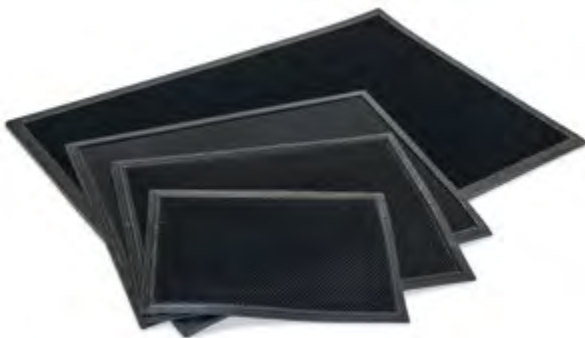

L	A	H	Kg	Barcode	€
530	370	17	2,90	481460	15,00
700	500	17	3,75	481462	25,00
800	600	17	3,55	481464	37,00
1200	800	17	3,55	481466	125,00



Hachas

Axes
Haches

Hacha de cámara con mango de fibra

Chamber axe with polyethylene fibre handle
Hache de chambre avec manche en fibre



Applications:

Spéciale pour l'accomplissement de le règlement du UE pour chambres frigorifiques à grande superficie dont température de fonctionnement soit au-dessous de zéro.

On recommande son installation comme bonne coutume dans autres cases (restaurants, boucheries, poissonneries, etc.) ou on peut trouver chambres qui ne sont pas touchées par ce règlement, mais qui sont aussi à congélation et les travailleurs peuvent travailler dans s'intérieur avec la porte fermée.

Aplicación:

Especial para el cumplimiento del reglamento de Industria ("Reglamento de Seguridad para Plantas e Instalaciones Frigoríficas", RD 3099/77) para cámaras frigoríficas de gran superficie cuya temperatura de trabajo sea inferior a 0 grados.

Se recomienda su instalación, como buena práctica, en otros casos (restaurantes, comercios, etc.) donde se pueden encontrar cámaras no afectadas por el reglamento de Industria, pero que son de congelación y en las que los trabajadores puedan trabajar en el interior de las mismas con la puerta cerrada.

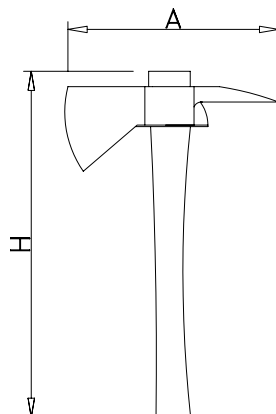

Use:

Special for the compliance of the EU regulations on cold rooms of wide area which can work with temperatures below zero.

It is recommended to install it as a good use in other cases (restaurants, butcher shops, fish shops, etc.) where you can find cold rooms not affected by with this regulation, but that are also cold rooms where workers can work inside them with the door closed.

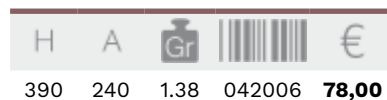

Hacha de bombero con mango de fibra

Firefighter axe with polyethylene fibre handle
Hache de pompier avec manche en fibre



Applications:

Spéciale pour l'accomplissement de le règlement du UE pour chambres frigorifiques à grande superficie dont température de fonctionnement soit au-dessous de zéro.

On recommande son installation comme bonne coutume dans autres cases (restaurants, boucheries, poissonneries, etc.) ou on peut trouver chambres qui ne sont pas touchées par ce règlement, mais qui sont aussi à congélation et les travailleurs peuvent travailler dans s'intérieur avec la porte fermée.

Aplicación:

Especial para el cumplimiento del reglamento de Industria ("Reglamento de Seguridad para Plantas e Instalaciones Frigoríficas", RD 3099/77) para cámaras frigoríficas de gran superficie cuya temperatura de trabajo sea inferior a 0 grados.

Se recomienda su instalación, como buena práctica, en otros casos (restaurantes, comercios, etc.) donde se pueden encontrar cámaras no afectadas por el reglamento de Industria, pero que son de congelación y en las que los trabajadores puedan trabajar en el interior de las mismas con la puerta cerrada.

Use:

Special for the compliance of the EU regulations on cold rooms of wide area which can work with temperatures below zero.

It is recommended to install it as a good use in other cases (restaurants, butcher shops, fish shops, etc.) where you can find cold rooms not affected by with this regulation, but that are also cold rooms where workers can work inside them with the door closed.

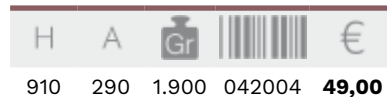



COMPLEMENTOS

COMPLEMENTS
COMPLEMENTS

NOVEDADES

NEWS
NOUVEAUTÉS



437



445



445



446

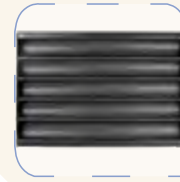

451



453



453

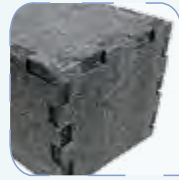

454



454

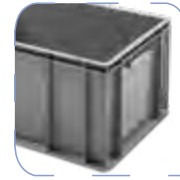

455



455



455



455



457



469



469



472



477



479



480

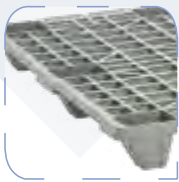

481



484



485



496



496





Cubetas para helado

Ice cream container
Bac à crème glacée



L	A	H	lit	Gr	Barcode	€
180	165	120	2,50	325	487400	34,50
330	165	120	5,00	610	487402	24,00
360	165	120	5,00	635	487404	19,00
330	250	80	5,50	600	487405	34,50
360	250	80	5,97	745	487406	18,00
265	160	80	3,00	310	487410	18,00
330	165	80	3,10	400	487412	21,00
360	165	80	3,30	430	487414	19,00
265	160	120	3,60	450	487416	18,00
330	250	120	7,00	890	487418	56,00
360	250	120	8,00	865	487419	27,00
265	160	150	4,00	590	487420	23,00
330	165	150	6,5	750	487422	28,00
360	165	150	6,5	590	487424	27,00
330	250	150	7,5	1.000	487426	61,00
360	250	150	10,8	985	487428	35,00

Características:

Cubetas de acero inoxidable conforme a la norma EN 631, utilizadas para el sector del helado.

Characteristics:

Set of stainless steel containers normalized according to the norm EN 631, used for ice cream.

Caractéristiques:

Série de bacs en acier inoxydable normalisés selon la norme EN 631, utilisées pour glacée.



∅200 250 7,85 520 487408 **62,00**



265 160 20 100 487448 **7,50**



330 165 20 120 487450 **7,50**

360 165 20 135 487452 **5,80**



360 250 80 180 487454 **8,00**



260 ∅ 50 mm. 487480 **5,50**

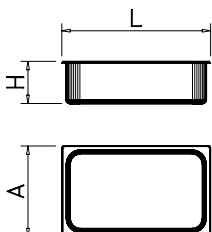

Lavaporcionador de helados para encastrar

Built-in ice-cream scoop washer
Rince bouliers à glace pour encastrar



Características:
Entrada de agua con válvula de 3/8"
Desagüe con válvula de 1/2"

Characteristics:
Inlet valve 3/8"
Outlet valve 1/2"

Caractéristiques:
Entrée d'eau avec bonde de 3/8"
Bonde d'évacuation de 1/2"

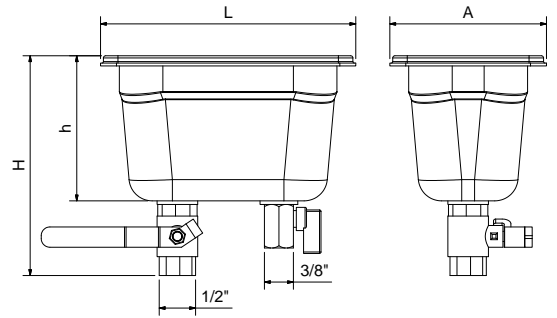

L	A	H	h	Gr	Barcode	€
176	108	151	100	500	082830	76,00

Lavaporcionador de helados mural

Wall-mounted ice-cream scoop washer
Rince bouliers à glace mural



Características:
Entrada de agua con válvula de 3/8"
Desagüe con válvula de 1/2"

Characteristics:
Inlet valve 3/8"
Outlet valve 1/2"

Caractéristiques:
Entrée d'eau avec bonde de 3/8"
Bonde d'évacuation de 1/2"

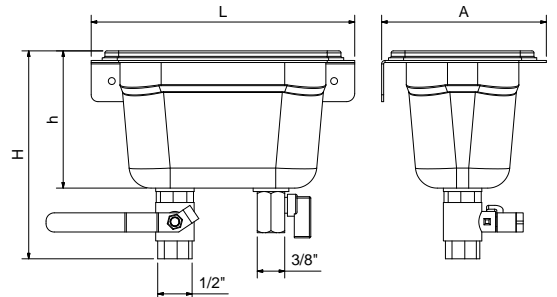

L	A	H	h	Gr	Barcode	€
192	120	151	100	700	082832	97,00

Porcionadores de helado

Stainless steel and nylon ice cream scoop
Boulier à glace



∅
50
mm.

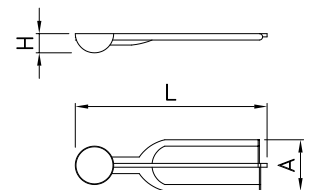

L	A	H	Color	Gr	Barcode	€
190	65	33		200	487470	34,00
				200	487472	
				200	487474	
				200	487476	

Porcionador automático de helado

Spring action ice-cream scoop

Cuillère à crème glacée avec lame intérieur



∅
50
mm.

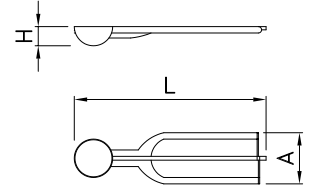

L	A	H	Gr	Barcode	€
220	65	50	220	440016	6,00

Copa helado

Ice cream bowl

Bowl pour crème glacée

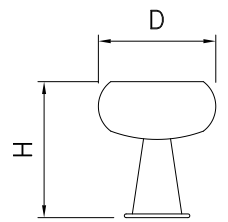

H	D	Gr	Barcode	€
110	85	150	487490	23,00
110	95	180	487492	27,00
110	105	200	487494	29,00

Bandeja de exposición para helados en vaso

Display tray for ice cream glass

Plateau Présentoir pour glaces en pot

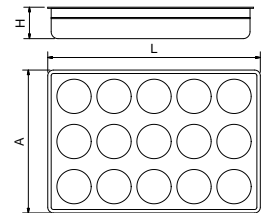

L	A	H	Gr	Barcode	€
354	245	55	350	487430	54,00

Bandeja de exposición para helados polos

Display tray for ice poles

Plateau Présentoir pour glaces esquimaux

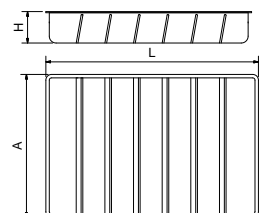

L	A	H	Gr	Barcode	€
354	245	55	350	487432	33,00

Cubetas Gastronorm lisas

Non-perforated Gastronorm containers
Bacs Gastronorm lisses



Características:

Cubetas conforme a la norma EN 631, utilizadas para la preparación, cocción, congelación, descongelación y distribución de alimentos.

Fabricadas en acero inoxidable.

Posibilidad de encargar bajo pedido: Cubetas con asas, tapaderas con orificio para cuchara y tapaderas con junta hermética.

Characteristics:

Set of containers normalized according to the norm EN 631, used for the preparation, cooking, freezing, defrosting and distribution of foodstuffs.

Made in stainless steel.

Possibility of make to order: container with handles, kitchen spoon lids, lids with hermetic joints.

Caractéristiques:

Série de bacs normalisés selon la norme EN 631, utilisées pour la préparation, cuisson, surgélation, décongélation et distribution des aliments.

Fabriquées en acier inoxydable.

Possibilité de demander sur commande: bac avec poignées, couvercles avec découpage pour louche, couvercles avec joint hermétique.

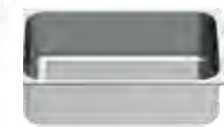
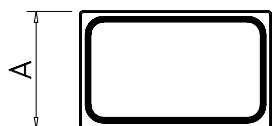
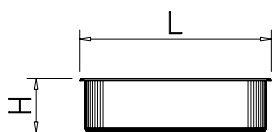

Modelo Model Model	L	A	H				€
1/1 - 20	530	325	20	2,75	1.100	486814	21,00
1/1 - 40	530	325	40	5,50	1.269	486816	24,00
1/1 - 65	530	325	65	9,50	1.365	486818	27,00
1/1 - 100	530	325	100	14,00	1.652	486820	34,00
1/1 - 150	530	325	150	21,00	1.965	486822	50,00
1/1 - 200	530	325	200	28,00	2.292	486824	58,00
1/2 - 20	325	265	20	1,38	475	486838	12,00
1/2 - 40	325	265	40	2,20	573	486840	14,00
1/2 - 65	325	265	65	3,70	663	486842	16,00
1/2 - 100	325	265	100	6,50	818	486844	19,00
1/2 - 150	325	265	150	9,50	944	486846	30,00
1/2 - 200	325	265	200	12,50	1.350	486848	38,00
1/3 - 20	325	176	20	0,90	317	486850	10,80
1/3 - 40	325	176	40	1,50	380	486852	12,00
1/3 - 65	325	176	65	2,50	488	486854	14,00
1/3 - 100	325	176	100	3,70	581	486856	16,00
1/3 - 150	325	176	150	5,70	698	486858	24,00
1/3 - 200	325	176	200	7,70	770	486860	31,00
1/4 - 20	265	162	20	0,69	236	486862	9,90
1/4 - 40	265	162	40	1,37	286	486864	12,00
1/4 - 65	265	162	65	1,60	355	486866	13,00
1/4 - 100	265	162	100	2,80	449	486868	15,00
1/4 - 150	265	162	150	4,20	559	486870	21,00
1/4 - 200	265	162	200	5,80	644	486872	26,00
1/6 - 20	176	162	20	0,46	167	486874	8,50
1/6 - 40	176	162	40	0,90	236	486876	10,00
1/6 - 65	176	162	65	1,00	267	486878	10,50
1/6 - 100	176	162	100	1,80	346	486880	12,50
1/6 - 150	176	162	150	2,40	398	486882	17,00
1/6 - 200	176	162	200	2,60	640	486884	28,00
1/9 - 65	176	108	65	0,50	195	486886	10,00
1/9 - 100	176	108	100	0,90	230	486888	14,00
2/1 - 20	650	530	20	5,70	2.726	486802	54,00
2/1 - 40	650	530	40	10,50	2.957	486804	48,00
2/1 - 65	650	530	65	18,50	3.255	486806	65,00
2/1 - 100	650	530	100	28,00	3.650	486808	77,00
2/1 - 150	650	530	150	42,00	4.230	486810	106,00
2/1 - 200	650	530	200	56,50	4.800	486812	123,00
2/3 - 20	354	325	20	1,85	708	486826	16,00
2/3 - 40	354	325	40	3,20	803	486828	18,00
2/3 - 65	354	325	65	5,50	830	486830	19,00
2/3 - 100	354	325	100	8,70	1.116	486832	25,00
2/3 - 150	354	325	150	13,00	1.380	486834	41,00
2/3 - 200	354	325	200	18,00	1.639	486836	48,00
2/4 - 20	530	162	20	1,37	550	486890	14,00
2/4 - 40	530	162	40	2,75	634	486892	19,00
2/4 - 65	530	162	65	4,75	682	486894	22,00
2/4 - 100	530	162	100	7,00	826	486896	33,00
2/4 - 150	530	162	150	10,50	982	486898	43,00

Cubetas Gastronorm perforadas

Perforated Gastronorm containers
Bacs Gastronorm perforé

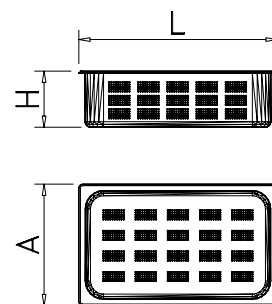

Modelo Model Model	L	A	H		Gr		€
1/1 - 40	530	325	40	5,50	1.320	487012	27,00
1/1 - 65	530	325	65	9,50	1.305	487014	30,00
1/1 - 100	530	325	100	14,00	1.570	487016	39,00
1/1 - 150	530	325	150	21,00	1.820	487018	62,00
1/1 - 200	530	325	200	28,00	2.053	487020	73,00
1/2 - 40	325	265	40	2,20	598	487032	16,00
1/2 - 65	325	265	65	3,70	660	487034	18,00
1/2 - 100	325	265	100	6,50	745	487036	23,00
1/2 - 150	325	265	150	9,50	890	487038	37,00
1/2 - 200	325	265	200	12,50	1.275	487040	46,00
2/1 - 40	650	530	40	10,50	2.764	487002	59,00
2/1 - 65	650	530	65	18,50	3.087	487004	66,00
2/1 - 100	650	530	100	28,00	3.480	487006	89,00
2/1 - 150	650	530	150	42,00	3.870	487008	125,00
2/1 - 200	650	530	200	56,50	4.480	487010	143,00
2/3 - 40	354	325	40	3,20	757	487022	20,00
2/3 - 65	354	325	65	5,50	790	487024	22,00
2/3 - 100	354	325	100	8,70	1.051	487026	31,00
2/3 - 150	354	325	150	13,00	1.278	487028	48,00
2/3 - 200	354	325	200	18,00	1.500	487030	57,00

Tapas para cubetas Gastronorm

Lid for Gastronorm containers
Couvercle pour bacs Gastronorm

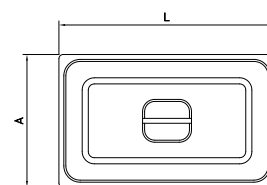

Modelo Model Model	L	A	Gr		€
1/1	530	325	1.100	487202	21,00
1/2	325	265	500	487206	12,00
1/3	325	176	350	487208	9,00
1/4	265	162	255	487210	8,00
1/6	176	162	180	487212	7,00
1/9	176	108	110	487214	6,40
2/3	354	325	662	487204	15,00
2/4	530	162	331	487216	15,00

Tapa antidesbordamiento inox para cubeta GN gastronorm

Anti-overflow stainless steel lid for GN gastronorm containers
Couvercle anti-débordement pour bac gastronorme



Modelo Model Model	Gr	Barcode	€
1/1	1150	487232	59,00
1/2	540	487234	39,00
1/3	380	487236	30,00
1/4	275	487238	25,00
1/6	195	487240	23,00
2/3	680	487242	42,00

Doble fondo para cubeta gastronorm

Double bottom for GN container
Double fond pour bac gastronorme



Características:

Fabricados en acero inoxidable, estos doble fondos de cubetas GN perforados son óptimos para la conservación de aquellos alimentos que liberan líquido y/o jugos durante su conservación.

Estos dobles fondos impiden que los alimentos se conserven húmedos, aumentando así la duración de los mismos y, por lo tanto, reduciendo el desperdicio.

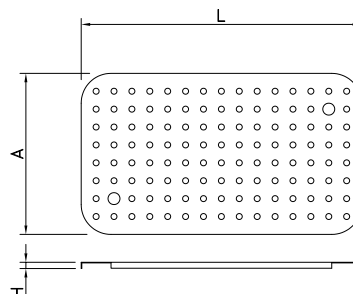

Characteristics:

Made of stainless steel, this double bottom for GN container is optimal for preservation of those foods that release liquid or juices during their preservation.

This double bottom preserves food from a humid preservation to extend their lifespan and to reduce their waste.

Caractéristiques:

Fabriqués en acier inoxydable, ces doubles fonds pour bacs GN perforés sont optimaux pour la conservation des aliments qui libèrent du liquide lors du stockage.

Ce double fond évite le maintien de l'humidité des aliments, augmentant ainsi leur durée et, par conséquent, la réduction des déchets.

L	A	H	Modelo Model Model	Gr	Barcode	€
470	270	10	1/1	667	487252	18,00
270	210	10	1/2	316	487256	12,00
590	470	10	2/1	1.512	487250	32,00
300	270	10	2/3	438	487254	14,00



BPA o Bisphenol A es una sustancia tóxica presente en algunas cubetas, biberones y otros elementos de plástico. Se libera principalmente al calentar estos productos tanto en microondas o al esterilizarlos en agua de manera convencional. BPA FREE garantiza que este producto no está fabricado con BPA.

BPA or Bisphenol A is a toxic substance that is present in some containers, feeding bottles and other plastic elements. It is particularly released when these materials are heated in a microwave or conventionally sterilized in water. BPA FREE guarantees that this product does not contain BPA.

BPA ou Bisphénol A est une substance toxique qui est présente dans certains bacs, biberons et des autres éléments en plastique. Il est particulièrement libérée lorsque ces produits sont chauffés dans un four micro-ondes ou sont stérilisés dans l'eau de façon conventionnelle. BPA FREE garantit que ce produit ne contient pas de BPA.

Cubetas Gastronorm copoliéster

Gastronorm containers in copolyester
Bacs Gastronorm en copolyester



Ver pag. 438
See page 438
Voir page 438

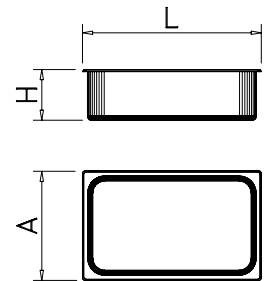

Modelo Model Model	L	A	H				€
1/1 - 65	530	325	65	9,50	700	487604	23,00
1/1 - 100	530	325	100	14,00	800	487606	29,10
1/1 - 150	530	325	150	21,00	980	487608	34,30
1/1 - 200	530	325	200	28,00	1.145	487610	42,30
1/2 - 65	325	265	65	3,70	330	487612	13,50
1/2 - 100	325	265	100	6,50	410	487614	13,90
1/2 - 150	325	265	150	9,50	470	487616	17,00
1/2 - 200	325	265	200	12,50	675	487618	21,30
1/3 - 65	325	176	65	2,50	240	487620	10,60
1/3 - 100	325	176	100	3,70	290	487622	12,40
1/3 - 150	325	176	150	5,70	350	487624	15,20
1/3 - 200	325	176	200	7,70	390	487626	18,00
1/4 - 65	265	162	65	1,60	180	487628	8,60
1/4 - 100	265	162	100	2,80	230	487630	10,00
1/4 - 150	265	162	150	4,20	280	487632	12,00
1/4 - 200	265	162	200	5,80	325	487634	15,00
1/6 - 65	176	162	65	1,00	135	487636	6,40
1/6 - 100	176	162	100	1,80	175	487638	7,40
1/6 - 150	176	162	150	2,40	200	487640	9,30
1/6 - 200	176	162	200	2,60	325	487642	11,50
1/9 - 65	176	108	65	0,50	100	487644	5,00
1/9 - 100	176	108	100	0,90	120	487646	6,20
2/1 - 200	650	530	200	56,50	2.400	487602	81,00



Tapas para cubetas Gastronorm copoliéster

Lids for Gastronorm containers in copolyester
Couvercle pour bacs Gastronorm en copolyester



Ver pag. 438
See page 438
Voir page 438

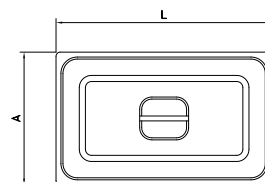

Modelo Model Model	L	A	Gr	Barcode	€
1/1	530	325	660	487220	18,00
1/2	325	265	300	487222	10,00
1/3	325	176	210	487224	7,00
1/4	265	162	153	487226	6,00
1/6	176	162	110	487228	5,00
1/9	176	108	70	487229	4,00
2/1	650	530	920	487218	46,00

Tapa hermética GN de copoliéster BPA-Free

Copolyester BPA-Free GN hermetic lid
Couvercle hermétique GN en copolyester BPA-Free



Ver pag. 438
See page 438
Voir page 438

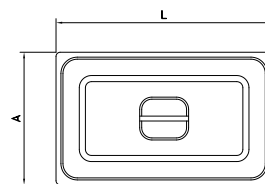

Modelo Model Model	L	A	Kg	Barcode	€
1/1	325	530	0,66	487244	16,00
1/2	325	265	0,30	487245	9,00
1/3	325	175	0,21	487246	7,40
1/4	264	162	0,15	487247	5,30
1/6	176	162	0,11	487248	4,00
1/9	176	108	0,07	487249	3,30

Fondos perforados para cubetas Gastronorm copoliéster

Perforated bottom for Gastronorm containers in copolyester
Fond pour bacs Gastronorm en copolyester



Ver pag. 438
See page 438
Voir page 438

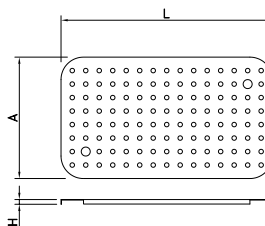

Modelo Model Model	L	A	H	Gr	Barcode	€
1/1	468	264	16	550	487260	11,00
1/2	264	204	16	250	487262	6,40
2/1	568	448	16	200	487258	27,00



Cubetas Gastronorm alta temperatura

Gastronorm containers high temperatures
Bacs Gastronorm hautes températures



Ver pag. 438
See page 438
Voir page 438

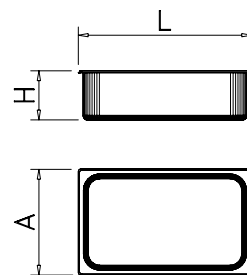

Características:

Fabricado con materiales de conformidad con la FDA.
Cumple con la normativa UNE EN 631-1.

BPA Free.

Sus principales cualidades son su gran resistencia a los golpes, identificación cómoda del contenido al poder ver a través de ellas, equipadas con una escala graduada con el sistema métrico y americano, preparadas para ser apiladas, fácil de limpiar, higienizables.

Resistentes a temperaturas de -40°C a +150°C.

Ideales para hornos microondas, baño maría etc.

Characteristics:

Made with FDA-approved materials.

Designed and manufactured in compliance with the UNE EN 631-1.

Free of Bisphenol A BPA Free.

The type of materials and thicknesses of the containers guarantee a perfect shock-resistance; they cannot easily be dented in case of accidental spills.

Completely smooth walls which allows for easily identification of the internal content and facilitates easy washing.

Equipped with a graded scale according both the metric and American system.

Edges for easy stacking.

Available with easy to place over lids.

Easy to clean and sanitizable.

Can withstand temperatures from -40 °C +150 °C.

Ideal for microwave ovens, bain-marie and general warming facilities.

Caractéristiques:

Fabriqué à la conformité de la FDA.

Conforme à la norme UNE EN 631-1.

BPA Free.

Ses principales qualités sont sa haute résistance aux chocs, l'identification du contenu pratique de pouvoir voir à travers eux, avec un gradient équipé d'un système métrique et américain, prêt à être empilés, facile à nettoyer, à l'échelle de higienizables.

Résistant de -40°C à +150°C. Température.

Ideal pour les fours à micro-ondes, des bains d'eau, etc..

Modelo Model Model	L	A	H		Gr		€
1/1 - 65	530	325	65	9,50	1.365	488002	52,00
1/1 - 100	530	325	100	14,00	1.652	488004	67,00
1/1 - 150	530	325	150	21,00	1.965	488006	77,00
1/2 - 65	325	265	65	3,70	663	488008	33,00
1/2 - 100	325	265	100	6,50	818	488010	38,00
1/2 - 150	325	265	150	9,50	944	488012	45,00
1/3 - 65	325	176	65	2,50	488	488014	24,00
1/3 - 100	325	176	100	3,70	581	488016	30,00
1/3 - 150	325	176	150	5,70	698	488018	37,00
1/4 - 65	265	162	65	1,60	355	488020	19,00
1/4 - 100	265	162	100	2,80	449	488022	23,00
1/4 - 150	265	162	150	4,20	559	488024	29,00
1/6 - 65	176	162	65	1,00	267	488026	14,00
1/6 - 100	176	162	100	1,80	346	488028	17,50
1/6 - 150	176	162	150	2,40	398	488030	22,00
1/9 - 65	176	108	65	0,50	195	488032	9,90
1/9 - 100	176	108	100	0,90	230	488034	11,50

Tapas para cubetas Gastronorm alta temperatura

Lids for Gastronorm containers high temperatures
Couvercle pour bacs Gastronorm hautes températures



Ver pag. 438
See page 438
Voir page 438

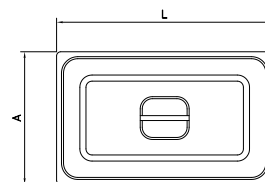

Modelo Model Model	L	A	Gr		€
1/1	530	325	1.100	488070	46,00
1/2	325	265	500	488072	24,00
1/3	325	176	350	488074	17,00
1/4	265	162	255	488076	13,30
1/6	176	162	180	488078	10,50
1/9	176	108	110	488080	6,50

Cubetas GN para identificación de alérgenos

Gastronorm containers for allergen marking
Cuvettes GN pour identification d'allergènes

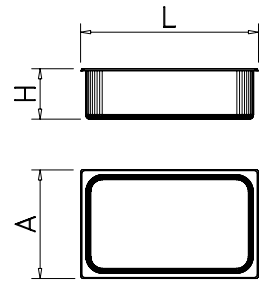

Características:

La línea de cubetas GN para identificación de alérgenos es el aliado ideal para cualquier establecimiento en el que se manipulen alimentos, ya que incorporan pictogramas de los posibles alérgenos y bastará con marcar con un rotulador (de borrado en húmedo) el tipo de alérgeno que contiene para su identificación. El recipiente se podrá reutilizar una vez lavado en lavavajillas pues tanto la tinta como los alérgenos habrán desaparecido.

Con este sistema se puede garantizar la información que proporcionar a clientes/usuarios, cumpliendo así con la normativa EU 1169/2011, que tiene como objetivo garantizar un elevado nivel de protección del consumidor en el campo de información de alimentos. Este Reglamento introduce, entre otras cosas, la obligación de los restaurantes a proporcionar información detallada a los clientes sobre la presencia de sustancias alergénicas contenidas en los alimentos.

Characteristics:

The line of GN trays for allergen identification will be the best resource for your business when processing food, since they incorporate easy to mark pictograms of any eventual allergen. As quick and easy as marking with a marker pen of wet erase the type of allergen it contains for a proper identification. The container can be reused once washed in the dishwasher as both the mark and the allergens will disappear.

Through this system you will provide your customers / users guaranteed information, thus complying with the EU 1169/2011 regulation, which aims to guarantee a high level of consumer protection in the field of food information. This Regulation introduces, among other things, the obligation of restaurants to provide detailed information to customers on the presence of allergenic substances contained in food.

Caractéristiques:

La gamme de bac GN pour l'identification des allergènes est l'allié idéal pour tout établissement où sont manipulés des aliments puisqu'ils intègrent des pictogrammes des allergènes possibles et il suffira de marquer avec un marqueur (effacement humide) le type d'allergène qu'il contient à votre identifiant. Le contenant peut être réutilisé une fois qu'il a été lavé au lave-vaisselle car l'encre et les allergènes auront disparu.

Avec ce système, les informations à fournir aux clients / utilisateurs peuvent être garanties, respectant ainsi le règlement UE 1169/2011, qui vise à garantir un niveau élevé de protection des consommateurs dans le domaine de l'information sur les denrées alimentaires. Ce règlement introduit, entre autres, l'obligation pour les restaurants de fournir des informations détaillées aux clients sur la présence de substances allergéniques contenues dans les denrées alimentaires.

Modelo Model Model	L	A	H	Gr	Gr	Barcode	€
1/1 - 65	530	325	65	9,00	700	488402	12,90
1/1 - 100	530	325	100	13,30	800	488404	14,10
1/1 - 150	530	325	150	20,00	980	488406	15,90
1/1 - 200	530	325	200	26,40	1.145	488408	19,80
1/2 - 65	325	265	65	4,00	330	488410	7,80
1/2 - 100	325	265	100	6,10	410	488412	8,50
1/2 - 150	325	265	150	9,00	470	488414	10,40
1/2 - 200	325	265	200	11,90	975	488416	12,20
1/3 - 65	325	176	65	2,50	240	488418	5,60
1/3 - 100	325	176	100	3,80	290	488420	7,40
1/3 - 150	325	176	150	5,50	350	488422	9,00
1/3 - 200	325	176	200	7,10	390	488424	10,50
1/4 - 65	265	162	65	1,70	180	488426	5,95
1/4 - 100	265	162	100	2,60	230	488428	6,45
1/4 - 150	265	162	150	3,80	280	488430	7,95
1/4 - 200	265	162	200	4,80	325	488432	9,20
1/6 - 65	176	162	65	1,00	135	488434	4,90
1/6 - 100	176	162	100	1,60	175	488436	5,50
1/6 - 150	176	162	150	2,30	200	488438	5,60
1/6 - 200	176	162	200	2,80	325	488440	7,00
1/9 - 65	176	108	65	0,60	100	488442	4,20
1/9 - 100	176	108	100	0,90	120	488444	4,65

Tapa para cubetas GN para identificación de alérgenos

Lid for Gastronorm containers for allergen marking
Couvercle pour Cuvettes GN pour identification d'allergènes

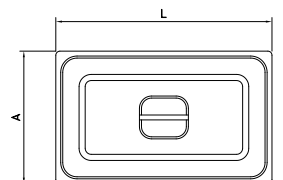

Modelo Model Model	L	A	Gr	Barcode	€
1/1	530	325	660	488460	6,50
1/2	325	265	300	488462	3,70
1/3	325	176	210	488464	3,00
1/4	265	162	153	488466	2,65
1/6	176	162	110	488468	2,30
1/9	176	108	70	488470	2,15

Recipientes de polipropileno

Containers in polypropylene
Bacs en polypropylene

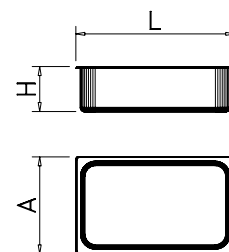

Características:

Fabricadas con materiales en conformidad con la FDA.

Solución económica para la preparación, almacenamiento y exposición de los alimentos.

Buena transparencia que permite fácilmente la identificación del contenido interior.

Resistente a temperaturas de -40°C a +80°C.

Equipado con una escala graduada con los sistemas métrico y estadounidense.

Apilables.

Characteristics:

Made with FDA-approved materials.

Excellent economical solution for the preparation, display and storage of food.

Excellent shock resistance at room temperature.

Good transparency allowing easily identification of the inside contents. Can withstand temperatures from -40 °C to +80 °C.

Equipped with a graded scale according both the American and metric systems.

Edges for easy stacking.

Available with transparent or colored hermetic lids.

Caractéristiques:

Fabriqué avec des matériaux conformes à la FDA.

Solution économique pour la préparation, le stockage et l'affichage de la nourriture.

Bonne transparence qui permet l'identification facile du contenu à l'intérieur.

Résistant à des températures de -40°C à +80°C.

Équipé d'un diplôme de niveau des systèmes métrique et US.

Empilable.

Modelo Model Model	L	A	H	Gr	Gr	Barcode	€
1/1 - 65	530	325	65	9,50	700	488202	10,00
1/1 - 100	530	325	100	14,00	800	488204	11,80
1/1 - 150	530	325	150	21,00	980	488206	14,60
1/1 - 200	530	325	200	28,00	1.145	488208	16,70
1/2 - 65	325	265	65	3,70	330	488210	6,40
1/2 - 100	325	265	100	6,50	410	488212	7,70
1/2 - 150	325	265	150	9,50	470	488214	8,30
1/2 - 200	325	265	200	12,50	675	488216	8,80
1/3 - 65	325	176	65	2,50	240	488218	5,80
1/3 - 100	325	176	100	3,70	290	488220	6,00
1/3 - 150	325	176	150	5,70	350	488222	6,70
1/3 - 200	325	176	200	7,70	390	488224	7,80
1/4 - 65	265	162	65	1,60	180	488226	4,90
1/4 - 100	265	162	100	2,80	230	488228	5,30
1/4 - 150	265	162	150	4,20	280	488230	6,00
1/4 - 200	265	162	200	5,80	325	488232	8,60
1/6 - 65	176	162	65	1,00	135	488234	4,20
1/6 - 100	176	162	100	1,80	175	488236	4,30
1/6 - 150	176	162	150	2,40	200	488238	5,00
1/6 - 200	176	162	200	2,60	325	488240	7,50
1/9 - 65	176	108	65	0,50	100	488242	4,00
1/9 - 100	176	108	100	0,90	120	488244	4,10

Tapas para recipientes de polipropileno

Lids for containers in polypropylene

Couvercles pour bacs en polypropylene

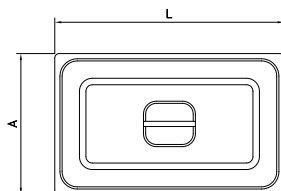

Modelo Model Model	L	A	Gr	Barcode	€
1/1	530	325	660	488270	5,70
1/2	325	265	300	488272	3,90
1/3	325	176	210	488274	3,50
1/4	265	162	153	488276	3,00
1/6	176	162	110	488278	2,90
1/9	176	108	70	488280	2,90

Fondos perforados para recipientes de polipropileno

Perforated bottoms for containers in polypropylene

Fonds pour bacs en polypropylene

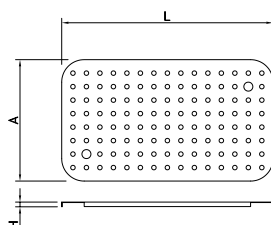

Modelo Model Model	L	A	H	Gr	Barcode	€
1/1	468	264	16	550	487268	5,00
1/2	264	204	16	250	487269	3,40

Tapa hermética GN de polipropileno BPA-Free

Polypropylene BPA-Free GN hermetic lid
Couvercle hermétique GN en polypropylène BPA-Free



Características:

Tapas herméticas para uso alimentario, fabricadas en polipropileno transparente. Este material es la alternativa perfecta al policarbonato, ya que está completamente libre de Bisphenol A (BPA-Free). La transparencia de este material facilita la identificación del contenido del recipiente sin necesidad de apertura. Además tienen una gran resistencia anticorrosión y ante posibles colisiones.

La tapa incorpora una junta que posibilita el cierre hermético del recipiente, lo que favorece a preservar los alimentos más frescos durante más tiempo, así como evitar la apertura involuntaria de la tapa, evitando por lo tanto desperdicios involuntarios. Disponibles para los diferentes tamaños de cubetas GN.

Characteristics:

Hermetic covers for food use, manufactured in polypropylene. This material is the perfect alternative to polycarbonate, since it is completely free of Bisphenol A (BPA-Free).

Hermetic sealed lids for food use, made of transparent polycarbonate. The transparency of this material facilitates the identification of the content without opening the container. They also have a high resistance to corrosion and to possible collisions.

The incorporated seal allows the container to be hermetic, which helps to preserve the freshest foods for a longer time, as well as to avoid the inadvertent opening of the lid, thus avoiding involuntary waste.

Available for different sizes of GN buckets

Caractéristiques:

Couvercles hermétiques à usage alimentaire en polypropylène. Ce matériau est l'alternative parfaite au polycarbonate, car il ne contient pas de bisphénol A (sans BPA)

La transparence de ce matériau facilite l'identification du contenu du récipient sans nécessité d'ouverture. Ils ont également une grande résistance à la corrosion et aux possibles collisions.

Le couvercle comporte un joint qui permet la fermeture hermétique du récipient, ce qui favorise la conservation des aliments plus frais pendant une période prolongée, tout en évitant l'ouverture involontaire du couvercle, évitant ainsi les pertes involontaires.

Disponible pour les différentes tailles de cuvettes GN.

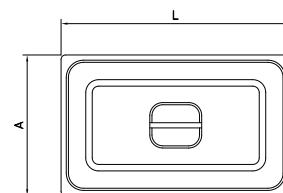

Modelo Model Model	L	A	Gr	Barcode	€
1/1	530	325	660	488282	15,10
1/2	325	265	300	488284	10,90
1/3	325	175	210	488286	7,90
1/4	264	162	153	488288	6,00
1/6	176	162	110	488290	5,90
1/9	176	108	70	488292	5,30



Tapas de polipropileno GN de colores

Polypropylene colored Gastronorm lids
Couvercles en polypropylène GN plusieurs couleurs

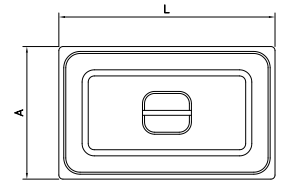

Modelo Model Model	L	A	Gr			€
1/1	530	325	660		488302	5,70
					488304	
					488306	
					488308	
1/2	325	265	300		488310	3,90
					488312	
					488314	
					488316	
1/3	325	176	210		488318	3,50
					488320	
					488322	
					488324	
1/4	265	162	153		488326	3,00
					488328	
					488330	
					488332	
1/6	176	162	110		488334	2,90
					488336	
					488338	
					488340	
1/9	176	108	70		488342	2,85
					488344	
					488346	
					488348	

Rejillas Gastronorm de acero inoxidable

Gastronorm grilles of stainless steel
Grilles gastronorm en acier inoxydable

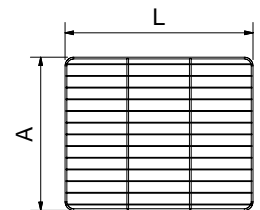
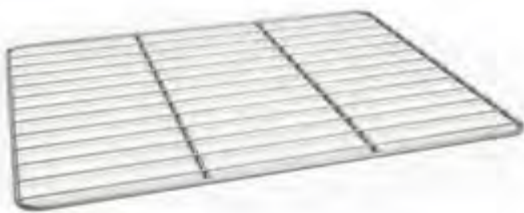

Modelo Model Model	L	A	Gr Kg	Kg		€
1/1	530	325	45	0,89	487272	32,00
1/2	325	265	31	0,48	487274	21,00
2/1	650	530	71	1,97	487270	52,00
Euronorm	600	400	17	0,88	487276	30,00

Perfiles divisorios para cubetas Gastronorm

Dividing section for Gastronorm containers
Profil diviseur pour bacs Gastronorm

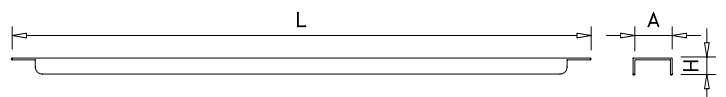

L	A	H	Gr		€
325	22	9,8	86	082820	5,00
530	22	9,8	146	082822	6,00

Escurridor inox para cubetas Gastronorm

GN container rack in stainless steel
Égouttoir inox pour bac Gastronorm



Novedad
en
nuevo



Fabricado en acero inoxidable, este escurridor para cubetas gastronorm será nuestro mayor aliado a la hora de eliminar el líquido excedente de nuestros recipientes.

Made of stainless steel, this rack for GN containers will be your best partner when draining the remaining liquids from our containers.

Fabriqué en acier inoxydable, cet égouttoir pour bac gastronorm sera notre meilleur allié lorsqu'il s'agira d'éliminer l'excès de liquide de nos récipients.

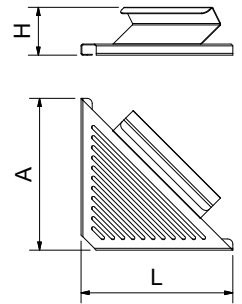

L	A	H	Gr	Barcode	€
150	150	47	130	082824	9,00

Soporte para tapa de cubeta Gastronorm

GN lid holder
Support pour couvercle de bac Gastronorm

Novedad
en
nuevo



Fabricado en acero inoxidable, este soporte para tapa de cubeta GN es ideal para mantener las cubetas abiertas sin la necesidad de buscarles una ubicación específica. Gracias a este utensilio, cada tapa quedará correctamente situada en cada cubeta, lo que evitará la posibilidad de mezclar las tapas de unos recipientes con otros y por lo tanto de producir algún tipo de contaminación cruzada.

Made of stainless steel, this holder for GN lids is ideal to keep the containers open, no matter where they are. Thanks to this tool, every lid will be in the right position on every container, which will avoid any possibility of mixing one lid with another container that could provoke cross contamination.

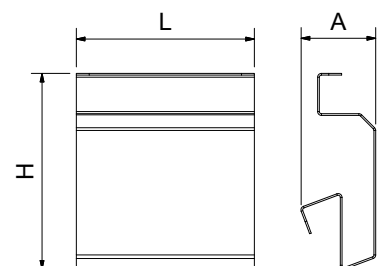

Fabriqué en acier inoxydable, ce support pour couvercle de bac GN est idéal pour maintenir les bacs ouverts sans avoir besoin de leur trouver un emplacement spécifique. Grâce à cet outil, chaque couvercle sera correctement placé dans chaque bac, ce qui évitera la possibilité de mélanger les couvercles de certains récipients avec d'autres et donc de produire un certain type de contamination croisée.

L	A	H	Gr	Barcode	€
83	35	91	105	082826	9,00

Asa universal para cubetas Gastronorm
Standard handle for Gastronorm containers
Manche universel pour bacs Gastronorm



Introducing the fastest, safest and cleanest way to place and remove insert pans at your food service facilities.

A tool that ends the injuries and food contamination that may occur when kitchen staff and food servers switch out pans at steam tables and buffet lines.
Heavy gauge stainless steel construction.
Pan removers lock-on when pushed inward and won't slip, allowing a steady and safe handling.
Prevents burns and pinched or broken fingers at hot tables.
Prevents food contamination.
Easy to use.
Dishwasher safe.



Nous présentons la forme la plus rapide, secore, et propre de placer et retirer cuveaux dans vos équipements de restauration.

Un outil qui finit avec les accidents et avec la contamination alimentaire qu'il peut se produire quand les cuisiniers et serveurs retirent des cuveaux du bain-marie et des buffets.
Construction en acier inoxydable à grand épaisseur.
L'anse se bloque quand est pressé vers dehors et ne se glisse pas.
Prévient des brûlures et des doigts coincés dans les tables chaudes.
Prévient la contamination alimentaire.
Facile à user.
Bon pour le lave-vaisselles.

Presentamos la forma más rápida, segura y limpia de colocar y retirar cubetas de sus equipamientos de restauración.

Una herramienta que acaba con los accidentes y con la contaminación alimentaria que pueden producirse cuando cocineros y camareros sacan cubetas de los baños maría y buffets.
Construcción en acero inoxidable de gran espesor.
El asa se bloquea cuando es presionada hacia dentro y no se desliza, garantizando una maniobrabilidad firme y segura.
Previene quemaduras y dedos aplastados en las mesas calientes.

Previene la contaminación alimentaria.
Fácil de usar.
Apto para lavavajillas.



El precio es por pareja.
The pair is included in the price.
Le paire est inclus dans de prix.

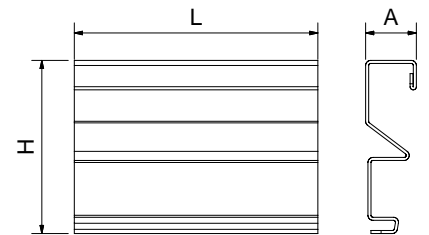

L	A	H	Gr	Barcode	€
120	22	80	200	082802	5,00

Fiambrrera de cristal con tapa hermética
Glass lunch box with airtight lid
Boîte à lunch en verre avec couvercle hermétique

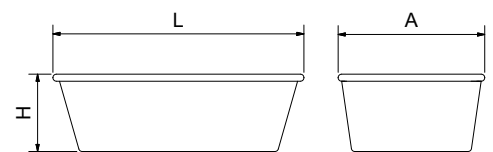

L	A	H	ml	Gr	Barcode	€
160	110	60	0,42	374	488602	5,00
225	160	85	1,50	1.000	488604	11,00

Bandejas de presentación inox

Stainless steel presentation trays
Plateaux de présentation en acier inoxydable

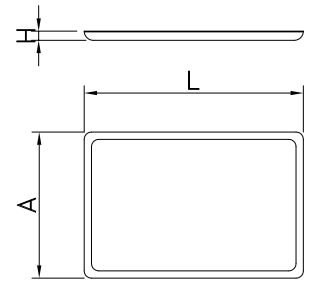

L	A	H	Gr	Barcode	€
315	215	15	200	480676	8,60
355	265	15	260	480677	9,00
395	295	15	337	480678	9,50
495	345	15	477	480679	11,00

Bandejas de presentación

Presentation trays
Plateaux de présentation

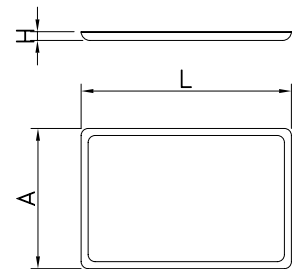

L	A	H	Color	Gr	Barcode	€
280	190	12	Black	150	480694 480692	6,00
350	240	12	Black	220	480732 480730	9,00
420	300	12	Black	340	480752 480750	12,00
600	400	25	Black	1.100	----- 480690	20,00

Bandejas de presentación BP2

Presentation tray BP2
Plateau de présentation BP2



Material polipropileno 100% alimentario.
Polypropylene material, totally food-safe.
Matériaux 100% polypropylène.

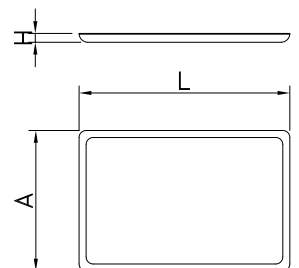

L	A	H	Gr	Barcode	€
430	310	31	400	480740	5,30

Bandeja Gastronorm de presentación BP3

Gastronorm presentation tray BP3
Plateau Gastronorm de présentation BP3



Material polipropileno 100% alimentario.
Polypropylene material, totally food-safe.
Matériaux 100% polypropylène.

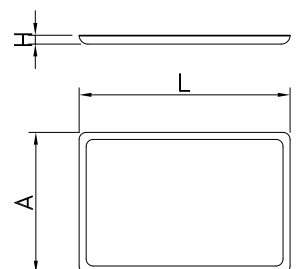

L	A	H	Gr	Barcode	€
530	325	14	600	480770	15,00

Bandeja Euronorm autoservicio en polipropileno azul

Euronorm self-service tray in blue polypropylene
Plateau libre-service Euronorm en polypropylène bleu

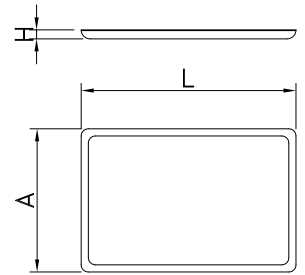

L	A	H	Gr	Barcode	€
530	370	26	150	480698	12,00

Bandeja Euronorm autoservicio en polipropileno con asas

Euronorm self-service tray in polypropylene with handles
Plateau libre-service Euronorm en polypropylène avec poignées

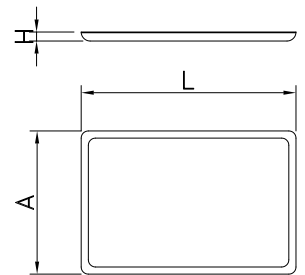

L	A	H	Gr	Barcode	€
530	370	21	160	480699	12,00

Bandeja inoxidable con asa

Stainless steel tray with handle
Plateau en acier inoxydable avec manche

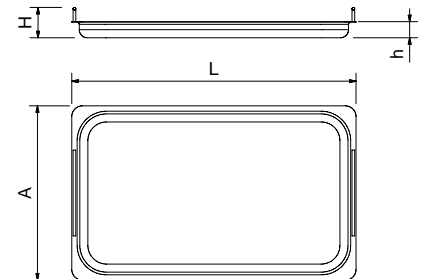

Modelo Model Model	L	A	H	h	Gr	Barcode	€
1/1	530	325	60	20	1.300	480672	48,00
2/1	650	530	60	20	2.920	480670	75,00
2/3	354	325	60	20	900	480674	41,00

Bandeja menú inoxidable

Stainless steel menu trays
Plateau repas en acier inoxydable

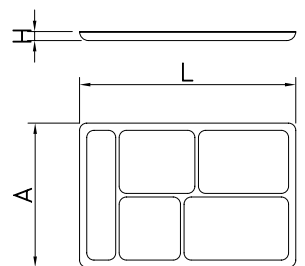

L	A	H	Gr	Barcode	€
400	300	30	4	844 482802	28,00
440	350	30	5	1.106 482804	31,00

Bandeja de comedor autoservicio inox

Stainless steel self-service dining tray
Plateau de repas libre-service en acier inoxydable

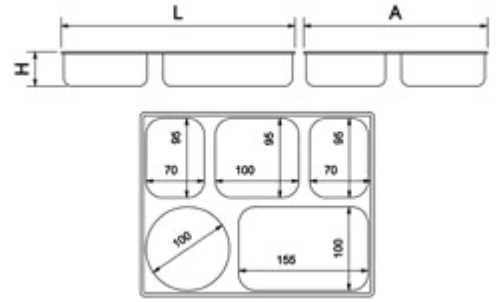

L	A	H	Gr	Barcode	€
280	220	40	5	482806	10,00

Bandeja isotérmica polipropileno Euronorm 1/1 para colectividades 5 compartimentos

Isothermal meal distribution tray in polypropylene with lid, 5 compartments.
Plateau repas isotherme en polypropylène avec couvercle 5 compartiments

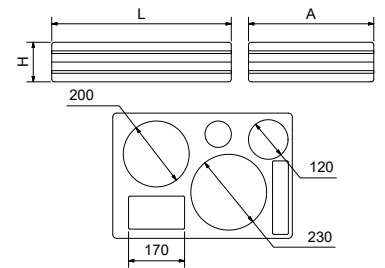

L	A	H	Kg	Barcode	€
545	370	120	3,0	482810	91,00

Bandejas de camarero de acero inoxidable

Stainless steel waiter trays
Plateaux de serveur en acier inoxydable

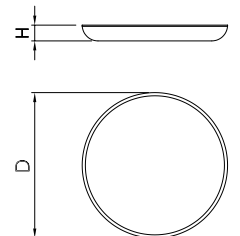

D	H	Gr	Barcode	€
310	20	350	480640	38,00
360	20	600	480642	44,00
410	20	800	480644	57,00

Bandeja de camarero de acero inoxidable especial jarras de cerveza

Stainless steel trays for beer
Plateau garçon de café en acier inoxydable spécial pour pichet de bière

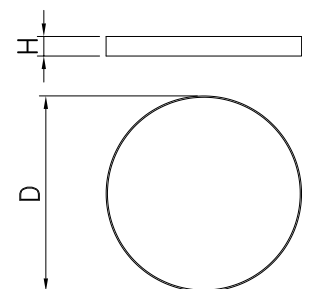

D	H	Gr	Barcode	€
300	30	560	480646	39,00
400	40	920	480648	57,00

Bandeja de cambio sencilla
Simple change tray
Porte-pourboire simple

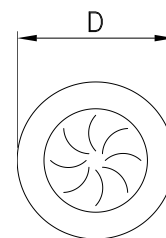

D	Gr	Barcode	€
120	10	486230	1,40

Bandeja de cambio
Change tray
Porte-pourboire

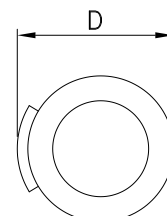

D	Gr	Barcode	€
130	11	486234	2,31

Bandeja de cambio rectangular con clip
Rectangular change tray
Porte-pourboire rectangulaire avec clip

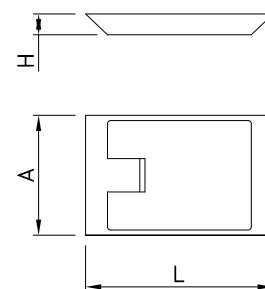

L	A	H	Gr	Barcode	€
180	115	20	20	486232	2,31

Bandejas aluminio antiadherente
Non-stick aluminium tray
Plateaux aluminium anti-adhérent

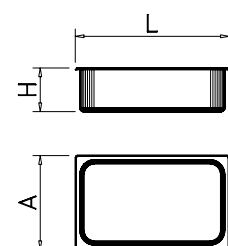

Modelo Model Model	L	A	H	Gr	Barcode	€
1/1	530	325	20	720	480702	44,00
1/1	530	325	40	800	480704	51,00
1/1	530	325	65	880	480706	56,00
2/3	354	325	20	510	480708	34,00
2/3	354	325	40	570	480710	38,00
2/3	354	325	65	650	480712	44,00
1/2	325	265	20	420	480714	28,00
1/2	325	265	40	450	480716	32,00
1/2	325	265	65	520	480718	36,00

Bandeja pastelera en acero inoxidable
 Stainless steel baking tray
 Plateau à pâtisserie en acier inoxydable



No diseñadas para contener líquidos
 Not intended to contain liquids
 Ne sont pas conçus pour contenir des liquides

Bordes doblados a 90°
 Edges bent at 90°
 Rebord aplati à 90°

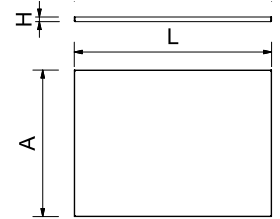

L	A	H	Kg	Barcode	€
300	400	9,5	0,8	083402	18,00
600	400	14,0	1,7	083404	27,00

Bandeja pastelera perforada
 Perforated pastry baking tray
 Plaque pâtisseries perforée



Aluminio reforzado AG5
 Espesor 1,5 mm
 4 esquinas a 45°
 Perforaciones de Ø 6 mm.

AG5 hard aluminium
 4 edges at 45°
 Thickness 1,5 mm
 With Ø 6 mm perforation

Aluminium AG5 dur
 Epaisseur 1,5 mm
 4 bords à 45°
 Avec perforation Ø 6

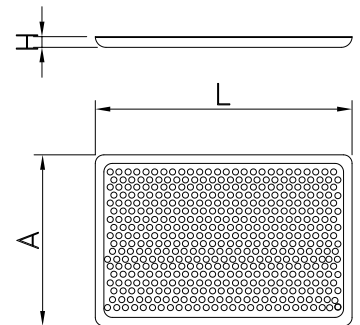

L	A	H	Gr	Barcode	€
605	405	30	500	480630	19,00

Bandeja de panadería acanalada en aluminio 600x400 mm.
 Baguette aluminum baking tray 600x400 mm.
 Plateau de boulangerie ondulé en aluminium 600x400 mm.



Base de chapa perforada.
 5 canales longitudinales.
 Antiadherente.
 1 mm de espesor

Perforated sheet base.
 5 longitudinal channels.
 Nonstick.
 1 mm thick.

Base en tôle perforée.
 5 canaux longitudinaux.
 Antiadhésif.
 1 mm d'épaisseur.

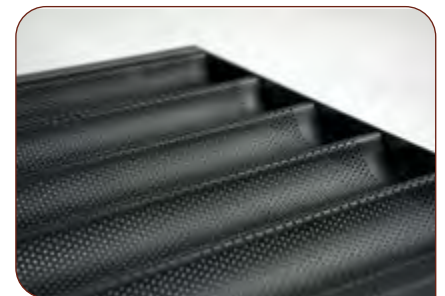
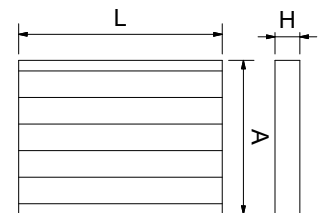

L	A	H	Bread Icon	Kg	Barcode	€
400	600	45	5	1,0	480634	45,00

Bandeja para marisco
Seafood tray
Plateau inox pour fruits de mer



Características:

Sistema modular para un perfecto acoplamiento y organización de la exposición del género en el mostrador de pescadería. Provista de agujeros a modo de desagüe. Construida totalmente en acero inoxidable.

Characteristics:

Modular system for a perfect fit and rack of the commodities displayed on the fish counter. Provided with holes for drainage. Made entirely of stainless steel.

Caractéristiques:

Système modulaire pour l'organisation de la fruits de mer sur l'étal à poisson. Avec trous pour le drainage. Fabriqué totalement en acier inoxydable.

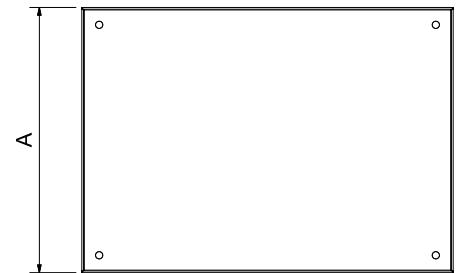
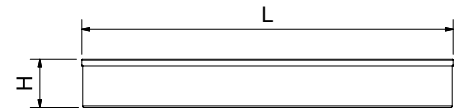

L	A	H	Kg	Barcode	€
480	287	50	1,35	083420	39,00

Caja de reparto/distribución apilable con tapa
Stackable distribution box with lid
Boîte de distribution empilable avec couvercle

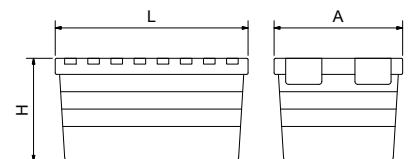

L	A	H	H	Kg	Barcode	€
600	400	320	60	2,90	483030	34,00
600	400	360	66	3,55	483034	36,00
600	400	410	77	3,75	483032	39,00

Contenedor Gastronorm aislamiento térmico

Gastronorm container for thermic isolation
Bac Gastronorm d'isolation thermique



Modelo Model Model	L	A	H	Gr	Barcode	€
1/1 - 120	600	400	170	550	487802	69,00
1/1 - 170	600	400	230	620	487804	74,00
1/1 - 220	600	400	270	710	487806	82,00

Placa eutéctica GN 1/1 acumulador de frío de 0 a -21°C

Eutectic plate GN 1/1 cold accumulator from 0 to -21°C
Plaque eutectique GN 1/1 accumulateur de froid de 0 à -21°C

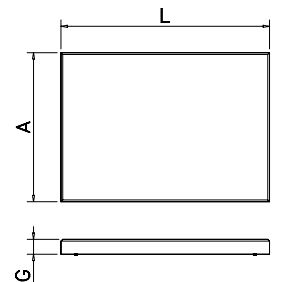

L	A	H	Kg	Barcode	€
530	325	30	5,10	487818	132,00

Contenedor isotérmico Euronorm 82 L.

Isothermal Euronorm container 82 liters
Conteneur isotherme Euronorm 82 L.



L	A	H	Kg	Barcode	€
690	490	370	1,60	487808	120,00

Forro isotermo interior para cajas de reparto / distribución

Inner isothermal lining for delivery / distribution boxes

Doublure intérieure isotherme pour boîtes de livraison / distribution



Novedad
NEW
Nouveauté



L	A	H	Gr	Barcode	€
		300	490	483031	58,50
550	350	380	650	483033	72,50

Contenedor isotérmico para bebidas con dispensador

Isothermal beverage container with dispenser

Réceptacle à boisson isotherme avec distributeur



Novedad
NEW
Nouveauté

Características:

Contenedor isotérmico para bebidas de 10 o 20 litros con dispensador anti-goteo. Fabricado en una sola pieza de polietileno sin uniones, que incorpora una pared doble de aislante de espuma de poliuretano.

Está diseñado para transportarlo de manera sencilla, gracias a las asas ergonómicas ubicadas en la parte superior. Asimismo también facilita su almacenaje y colocación gracias a que pueden apilarse.

Los pestillos de nylon aseguran una apertura y cierre sencillos a la vez que seguros.

Characteristics:

Isothermal container for drinks of 10 or 20 liters with anti-drip dispenser. Manufactured from a single piece of seamless polyethylene, incorporating a double wall of polyurethane foam insulation.

It is designed for easy portability, thanks to the ergonomic handles located on the top. It also can be stacked to storage and transport easily. Nylon latches ensure easy and secure opening and closing.

Caractéristiques:

Réceptacle isotherme pour boissons de 10 ou 20 litres avec distributeur anti-goutte. Fabriqué en une seule pièce de polyéthylène sans couture, incorporant une double paroi d'isolation en mousse de polyuréthane.

Il est conçu pour une portabilité facile, grâce aux poignées ergonomiques situées sur le dessus. Il facilite également le stockage et le placement grâce au fait qu'ils peuvent être empilés.

Les loquets en nylon assurent une ouverture et une fermeture faciles et sûres.

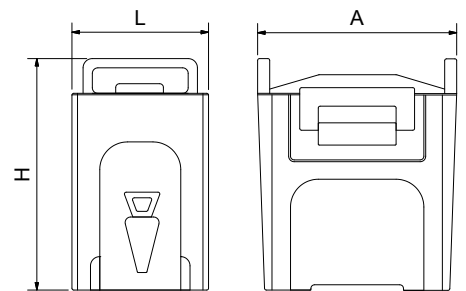

L	A	H	L	Kg	Barcode	€
295	430	500	10	5,95	481030	185,00
295	430	675	20	7,00	481032	230,00

Cajón liso apilable gris
Stackable grey plain box
Tiroir lisse empilable gris

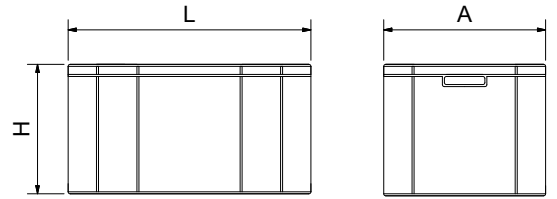

L	A	H		Kg		€
600	400	320	63	2,86	483036	38,00

Caja apilable multiusos 65 L.
Multipurpose stackable box 65 L.
Boîte gerbable polyvalent 65 L.

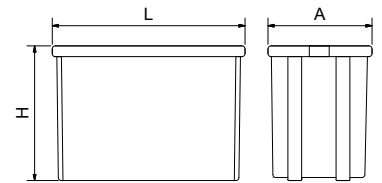

L	A	H		Kg		€
630	440	340	65	2,20	483042	28,00

Cajón para pescado o marisco con drenaje
Box with drain for fish and seafood
Tiroir pour poisson ou fruits de mer avec drainage

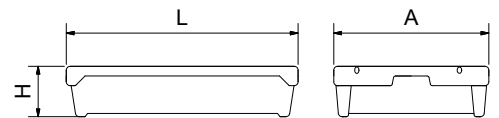

L	A	H		Kg		€
600	400	130	1,20	483038	15,50	



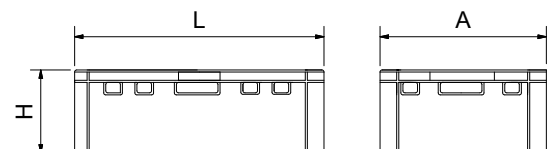

Cajón liso especial para carne
Plain bottom box, especially for meat
Tiroir lisse spécial viande

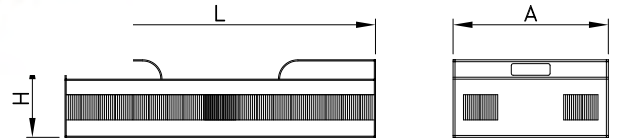

L	A	H		Kg		€
600	400	200	2,00	483040	24,50	

Cestas alimentarias
Food baskets
Paniers alimentaires



L	A	H		Kg		€
600	400	120		1,15	483008	19,00
600	400	200		1,75	483010	23,00

Cesta alimentaria ligera
Light food basket
Panier alimentaire légers

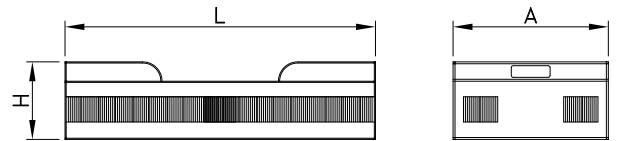

L	A	H	Gr		€
500	300	200	1,15	483012	12,00

Cesta alimentaria plegable
Foldable food basket
Paniers alimentaires pliables

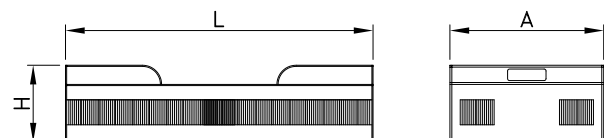

L	A	H	Gr		€
600	400	230	1,82	483014	21,00

Caja alimentaria apilable

Stackable box for food use
Boîte alimentaire empilable

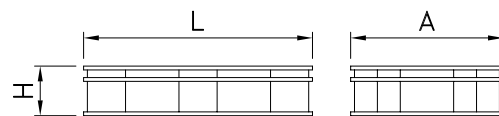

L	A	H	Kg	Barcode	€
400	300	100	0,75	440742	12,00
600	400	100	1,50	440736	15,00
600	400	130	1,65	440738	18,00

Tapa para caja alimentaria apilable

Lid for stackable food box
Couvercle pour boîte alimentaire empilable

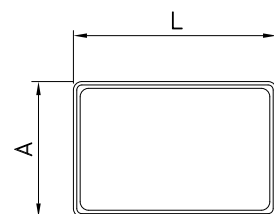

L	A	Gr	Barcode	€
400	300	450	440744	8,00
600	400	900	440740	11,00

Caja alimentaria apilable perforada para masa

Stackable perforated food box for dough
Boîte alimentaire perforée empilable pour pâte

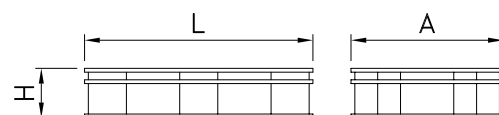

L	A	H	Kg	Barcode	€
600	400	100	1,25	440734	19,00

Cesta de supermercado sencilla

Simple shopping basket
Panier supermarché simple

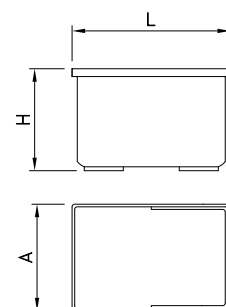

L	A	H	Gr	Barcode	€
430	300	220	600	481052	25,00

Cesta de la compra supermercado apilable 60 litros con ruedas

Stackable supermarket shopping basket with wheels, 60 liters
Panier de supermarché empilable 60 litres avec roulettes

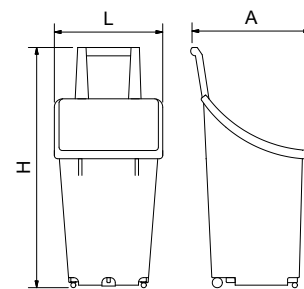

L	A	H	lit	Kg	Barcode	€
400	390	864	60	1,96	481054	45,00

Elevador inox para cesta de supermercado

Inox shopping trolley, special for supermarket baskets
Élévateur en acier inoxydable pour panier de supermarché

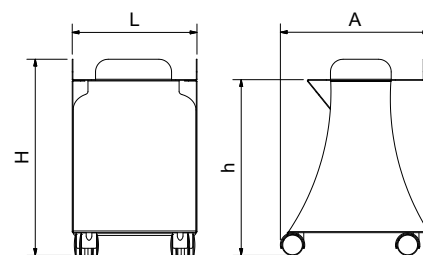

L	A	H	h	Kg	Barcode	€
297	277	467	419	5,60	081050	81,00

Cesta simple para lavavajillas

Dishwasher simple rack
Panier

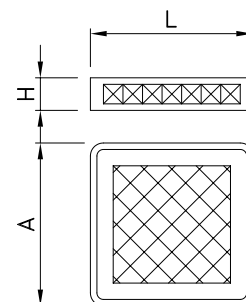

L	A	H	Kg	Barcode	€
400	400	100	1,00	483003	16,00
500	250	100	0,60	483005	11,00
500	500	102	1,22	483004	19,00

Extensión cesta simple

Rack basket extension
Extension de panier

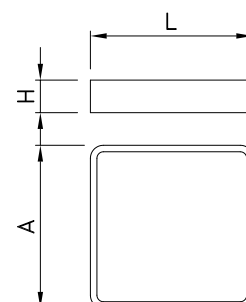

L	A	H	Kg	Barcode	€
500	500	40	0,46	483006	9,00

Cesta especial platos para lavavajillas

Dishwasher plates rack
Panier de lave-vaisselle pour assiettes

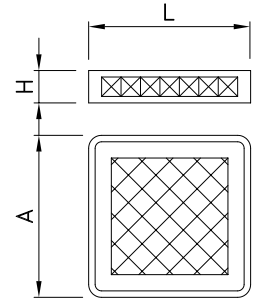

L	A	H	Kg	Barcode	€
500	500	102	1,32	483002	19,00

Cesta de lavavajillas para bandejas Euronorm o Gastronorm

Dishwasher rack for Euronorm or Gastronorm trays
Panier lave-vaisselle pour plateau Euronorm ou Gastronorm

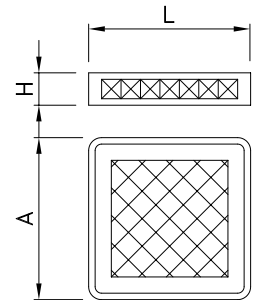

L	A	H	Kg	Barcode	€
500	500	100	1,70	483026	46,00

Tapa para cestas de lavavajillas

Lid for dishwasher racks
Couvercle pour panier de lave-vaisselle

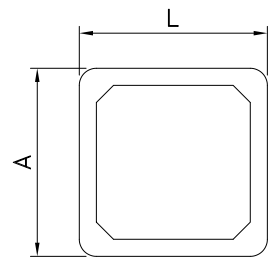

L	A	Gr	Barcode	€
500	500	400	483018	15,00

Cesta especial vasos para lavavajillas

Dishwasher glasses rack
Paniers pour verres pour lave-vaisselle

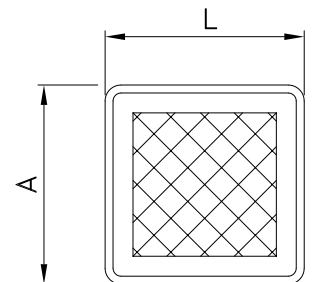

L	A	H	Glasses	Kg	Barcode	€
500	500	102	25	1,55	483020	24,00
			36	1,67	483022	26,00
			49	1,82	483024	28,00

Cestillo de plástico para cubiertos
 Plastic cutlery basket
 Plateau à couverts en plastique

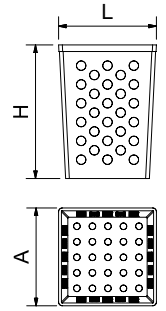

L	A	H	Gr	Barcode	€
110	110	130	100	454860	2,50

Enjuagador de vasos y jarras a presión para fregadero
 Pressure sink washer for glasses and jugs
 Nettoyeur haute pression pour verres et pichets pour évier

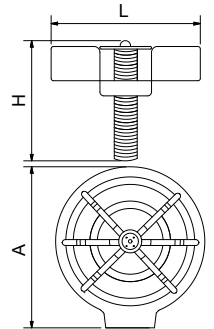

L	A	H	Gr	Barcode	€
150	130	173	200	454280	25,00

Cepillo lavavasos
 Glass washer brush
 Brosse pour lave-verres

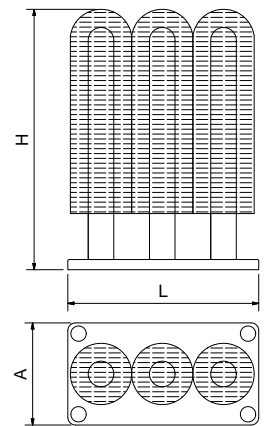

L	A	H	Gr	Barcode	€
190	100	190	390	483062	24,00

Rollo de 3m de bayeta posavasos antideslizante multiusos
 Multipurpose non-slip coaster cloth, 3m roll
 Rouleau de 3 m de tissu anti-dérapant multi-usages

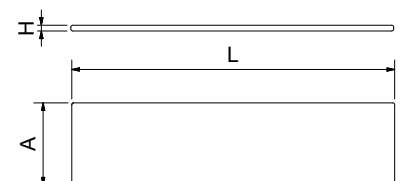

L	A	H	Kg	Barcode	€
3.000	650	1,00	1,00	482050	27,00

Cubertero
Cutlery tray organizer
Porte-couverts

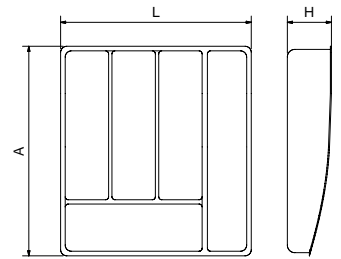

L	A	H	Gr	Barcode	€
245	330	48	450	486206	10,00

Cubertero plástico gris GN 1/1
Cutlery tray organizer GN 1/1
Range-couverts gris GN 1/1

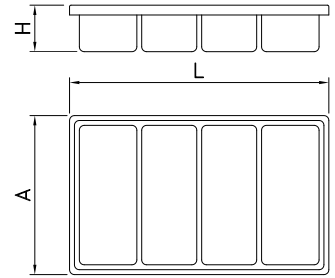

L	A	H	Gr	Barcode	€
530	325	95	500	486208	9,00

Tapa para cubertero plástico gris GN 1/1
Lid for cutlery rack GN 1/1
Couvercle pour Range-couverts gris GN 1/1

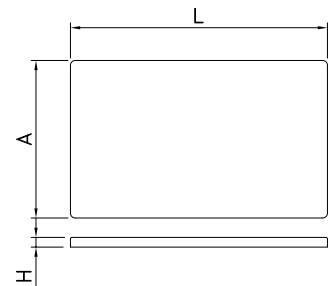

L	A	H	Gr	Barcode	€
530	325	20	400	486210	10,00

Separador de monedas y billetes
Coin and bill tray
Plateau à monnaie

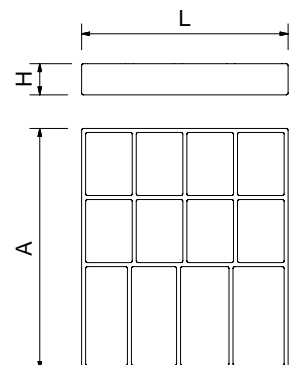

L	A	H	Kg	Barcode	€
311	363	47	0,45	486204	66,00

Porta-notas mural

Tab grabber
Porte-notes mural

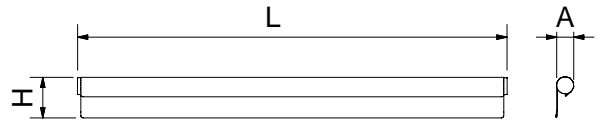

L	A	H	Gr	Barcode	€
508	20	34	400	081802	25,00

Botelleros

Wine racks
Porte-bouteilles



Fabricados en acero inoxidable AISI 304, han sido concebidos como complemento de decoración. Con un diseño de líneas sencillas, estos singulares botelleros se adaptarán a infinidad de espacios, sea cual sea su estilo de decoración.

Wholly constructed of stainless steel AISI 304, they have been thought as a complement in decorating. Thanks to its simple design, this outstanding line of wine racks will fit countless ambiances, whatever the style.



Totalemment construit en acier inoxydable AISI 304, ils ont été conçus comme un complément en décoration. Grâce à un dessin simple, ce singulier ligne de porte-bouteilles s'adapte à nombreuses ambiances, n'importe quel style décoratif.



L	A	H	D	Gr	Barcode	€
---	---	---	---	----	---------	---

109 100 615 92 800 083048 44,00



107	85	615	80	800	083050	40,00
-----	----	-----	----	-----	--------	-------

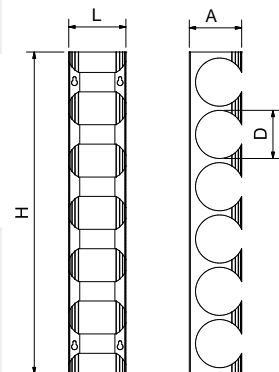

575	120	178	108	1.750	083060	70,00
-----	-----	-----	-----	-------	--------	-------

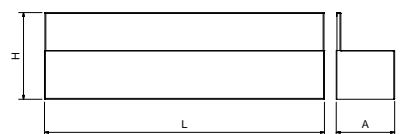

Cuelga copas
Wineglass rack holder
Accroche-coups



Con tope trasero para evitar la caída de las copas.

With backstop to prevent the falling of the cups.

Avec arrête buttoir pour empêcher la chute des tasses.

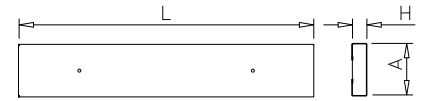

L	A	H	Gr	Barcode	€
470	88	25	575	083002	14,00
970	88	25	1.150	083004	19,00

Cuelga copas y tazas en varilla
Cup and mug rack holder
Porte tasses et verres à pied en tige inox

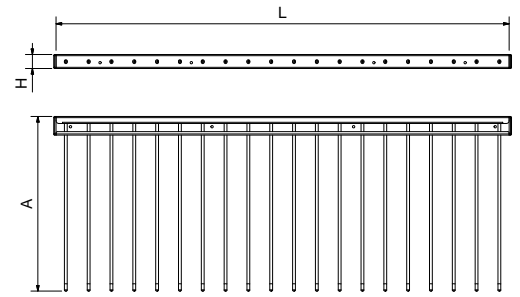
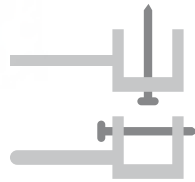

L	A	H	Kg	Barcode	€
973	375	30	3,20	083006	70,00

Dispensador de vasos
Cup dispenser
Distributeur de verres

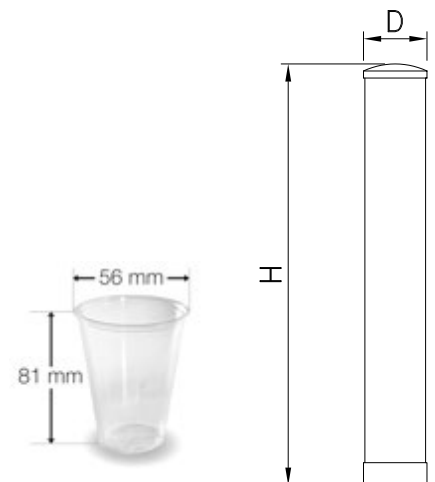

D	H	Gr	Barcode	€
90	597	450	483270	102,00

Dispensador de vasos universal

Universal cup dispenser
Distributeur universel de gobelets



Construido totalmente en acero inoxidable, ideal para exteriores e interiores.
Varillas regulables por lo que es válido para distintos tipos de vasos.
Diámetro de vaso 30-90 mm.

Totally made in stainless steel. Designed for indoor and outdoor use.
Adjustable rods to be adapted any cup size.
Cup diameter: 30-90 mm.

Construit entièrement en acier inoxydable, idéal pour les extérieurs et les intérieurs.
Tiges réglables donc valable pour différents types de gobelets.
Diamètre du verre 30-90 mm.

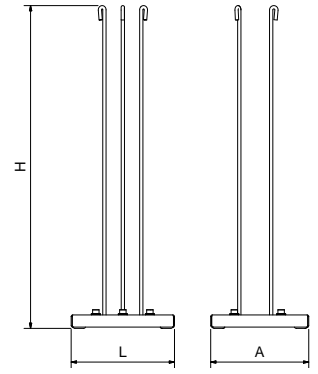

L	A	H	Gr	Barcode	€
158	150	493,5	795	080434	51,00

Soporte para cafeteras

Stand for coffee pot
Support pour machine à café

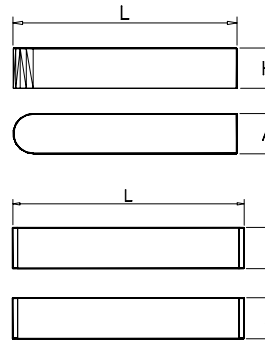

L	A	H	Kg	Barcode	€
---	---	---	----	---------	---

450	80	80	1,3	081202	89,00
-----	----	----	-----	--------	--------------

450	80	80	1,6	081204	40,00
-----	----	----	-----	--------	--------------

Escalones para vitrinas

Displays stages
Echelones



Especialmente concebidos para mejorar la exposición de las carnes y embutidos dentro de los mostradores frigoríficos estándar. Su diversidad de medidas facilitan su adaptación a cualquier modelo de expositor. Construidos en chapa de acero inoxidable que, además de garantizar al máximo su duración, es totalmente higiénico y favorece la distribución del frío. Provistos de pies regulables en altura.

Exclusively designed to improve the display of meat and sausage on the stands of standard fridges. Its diversity of sizes make easier the adaptation at any model of stand. Constructed in stainless steel sheet that guarantees the maximum length and furthermore favours the cold distribution.

Spécialement conçus pour améliorer l'exposition des viandes et des charcuteries dans les comptoirs frigorifiques standard. Sa diversité de dimensions facilitent sa adaptation a quelque modèle de comptoir. Construit en plaque d'acier inoxydable, lequel en plus de garantir au maximum sa durée, est totalement hygiénique et favorise la distribution du froid. Pourvu de pieds réglables en hauteur.

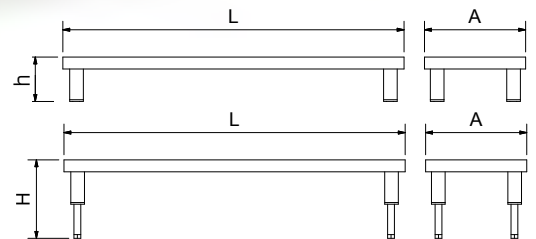

L	A	h	H	Kg	Barcode	€
800	300	130	230	2,8	082002	148,00
1.000	300	130	230	3,4	082004	154,00
1.200	300	130	230	3,9	082006	160,00
1.400	300	130	230	4,4	082008	175,00
600	400	130	230	2,8	082018	114,00
800	400	130	230	3,4	082010	160,00
1.000	400	130	230	4,0	082012	171,00
1.200	400	130	230	4,7	082014	175,00
1.400	400	130	230	5,4	082016	196,00

Soporte sobre-mostrador para balanzas

Stand support for scales
Support sur comptoir pour balances



Características:

Específicamente diseñados para colocar las balanzas, cortadoras de fiambre y demás maquinaria encima del mostrador.

Sus topes regulables permiten adaptarse a cualquier ancho de la tapa del mostrador.

Gran firmeza. Fácilmente montable y desmontable.

Characteristics:

Specifically designed for placing scales, sausage cutting and other machines on the stand.

Its width adjustable butts allow it to adjust to any width of the stand top.

Great firmness. Easy assembly and unassembly.

Caractéristiques:

Especialément desinés pour placer balances, coupe charcuteries et autres machines sur le comptoir.

Ses butoirs réglables en largeur le permettent s'adapter a quelque largeur du couverture sur le comptoir.

Gran solidité. Facilité por le monter et démonter.

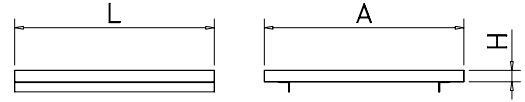

L	A	H	Kg	Barcode	€
390	390	30	3,3	082202	85,00

Tolva evacuación de desperdicios para adosar a tajos de troceo

Waste receptacle for scraps to fix to chopping blocks
Trémie d'évacuation des déchets pour adosser à billots



Válida para ser acoplada en los siguientes modelos de tajos:

Tajos de troceo lastrados.
Tajos de troceo de fibra con faldón.

Valid to be assembled in the following models of chopping blocks:
Reinforced and weighted.
Fibre chopping blocks with fringe.

Valide pour être couplé dans les suivantes modèles d'hachoirs a viande:
Hachoirs à viande blindés.
Hachoirs à viande en fibre avec support à pan.

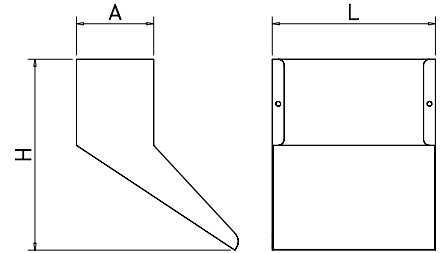

L	A	H	Kg	Barcode	€
275	130	324	2,3	082402	66,00

Pala para hielo

Ice spade
Pelle à glaçons



Características:

Su fabricación en polipropileno garantiza:

No absorbe agua.

No pierde su dureza en condiciones de humedad.

Puede ser esterilizado (no en autoclave).

Soporta temperaturas de hasta 100°C.

Characteristics:

It is made of polypropylene, which guarantees:

No water absorption.

No loss of hardness in humidity conditions.

Possibility of sterilization.

It resists temperatures up to 100°C.

Caractéristiques:

Sa fabrication en polypropylène garantit:

Pas d'absorption d'eau.

Pas de perte de dureté dans conditions d'humidité.

Possibilité de stérilisation.

Supporte température jusqu'à 100°C.

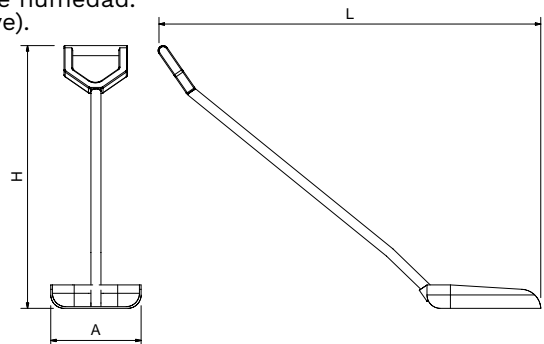

L	A	H	Kg	Barcode	€
1.107	279	890	1,5	474458	93,00

Pala de mano para hielo

Ice shovel
Pelle à glaçons



Characteristics:
It is made of polypropylene, which guarantees:
No water absorption.
No loss of hardness in humidity conditions.
Possibility of sterilization.
It resists temperatures up to 100°C.

Caractéristiques:
Sa fabrication en polypropylène garantit:
Pas d'absorption d'eau.
Pas de perte de dureté dans conditions d'humidité.
Possibilité de stérilisation.
Supporte température jusqu'à 100°C.

Características:

Su fabricación en polipropileno garantiza:
No absorbe agua.
No pierde su dureza en condiciones de humedad.
Puede ser esterilizado (no en autoclave).
Soporta temperaturas de hasta 100°C.

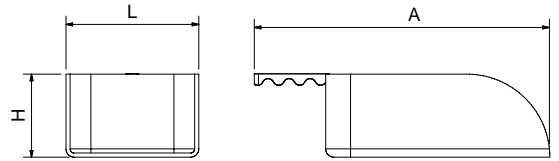

L	A	H	Gr	474456	€
160	340	90	150	474456	12,00

Recubrimiento modular para islas de congelación

Modular lid for island site freezers
Dessus vitré pour congélateurs libre-service



Características:

Sistema modular de cubiertas de vidrio o plástico, diseñado para actualizar las islas de congelados antiguas a las necesidades actuales de ahorro de energía.
Este sistema reduce la transferencia térmica en un 80%.
Perfilería de acero inoxidable.
Fácil de instalar.

Characteristics:

Modular system of glass or plastic lids designed to adapt the old frozen islands to the current needs of energy saving.
This system reduces the heat transfer by 80%.
Sections in stainless steel.
Easy to install.

Caractéristiques:

Système modulaire de dessus vitrés ou en plastique conçus pour adapter les congélateurs libre-service vieux aux besoins actuels d'économie énergétique.
Ce système réduit le transfert thermique le 80%.
Profils en acier inoxydable.
Facile à installer.

	max.		€	M. lineal linear meter mètre linéaire
Plástico Plastic Plastique	1.000	083850	294,00	
Cristal Glass Verre	1.000	083802	415,00	

Cubre aperitivos BC

BC appetizers screen
Vitrine à tapas BC

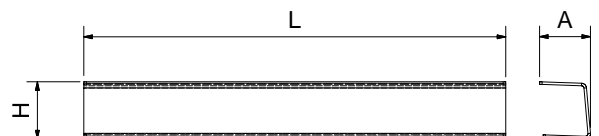
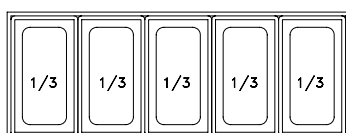
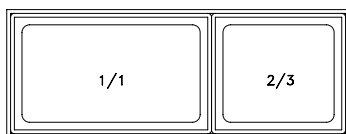

L	A	H	Kg	083604	€
1.000	125	135	2,00	083604	79,00

Vitrina cubre aperitivos

Counter top display
Vitrine à tapas



Características:

Capacidad de la vitrina: 5 cubetas GN 1/3 de 325x176 mm

Characteristics:

Display capacity: 5 containers GN 1/3 (325x176 mm)

Caractéristiques:

Capacité de la vitrine: 5 bacs GN 1/3 (325X176 mm)



Cubetas GN no incluidas.
GN containers not included.
Bac GN non inclus.

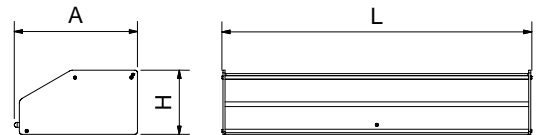
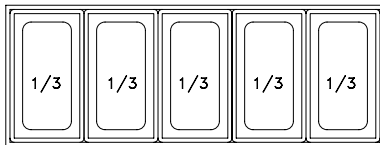
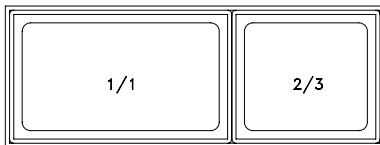

L	A	H	Kg	Barcode	€
918,5	365	190	4,50	083602	170,00

Cubierta basculante para cubetas Gastronorm 1/1

Dome cover for Gastronorm container 1/1
Couverture basculement pour bac gastro 1/1

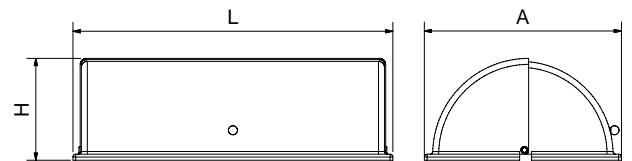

L	A	H	Kg	Barcode	€
530	325	175	1,5	487230	77,00

Vitrina bollería

Bakery display case
Vitrine viennoiserie

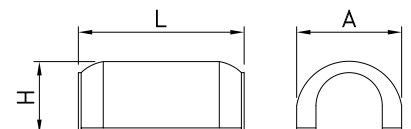

L	A	H	Kg	Barcode	€
450	300	180	1,00	440320	42,00

Vitrina bollería doble piso

Bakery display case - 2 displaying shelves
Vitrine viennoiserie double étage

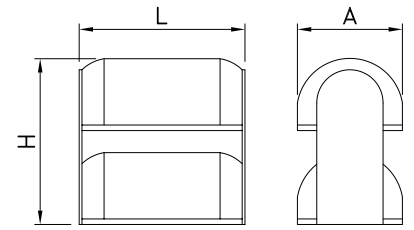

L	A	H	Gr	Barcode	€
300	190	320	800	440318	45,00
400	300	460	1260	440322	106,00

Gaveta expositora

Pick and mix bin
Casier de rangement

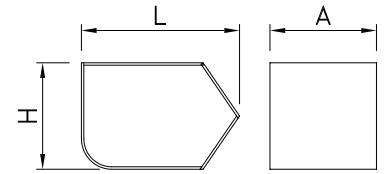

L	A	H	Gr	Barcode	€
260	175	175	600	483610	29,00

Queseras base plástico

Cheese keepers with plastic tray
Cloches à fromage base en plastique



Color al azar.
Random colour.
Colorido aleatoriamente.

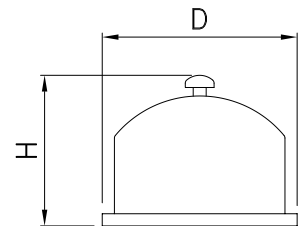

D	H	Gr	Barcode	€
245	175	450	480612	9,00

Pizarra de led con atril

LED blackboard with easel
Chevalet ardoise lumineuse LED



Rotuladores de tiza borrrable no incluido.

Not included erasable chalk marker.

Marquer craie effaçable non inclus.

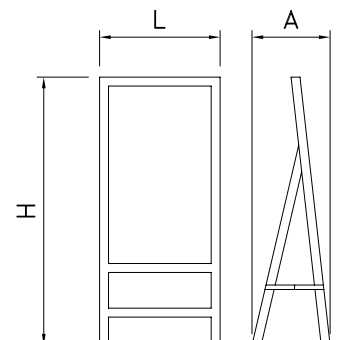

L	A	H	Kg	Barcode	€
540	350	1.200	2,40	480238	75,00

Cesta expositora de rejilla rectangular

Rectangular mesh display basket
Panier présentoir grillagé rectangulaire

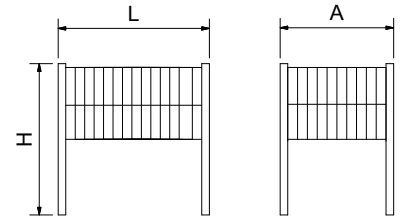

L	A	H	Kg	Barcode	€
800	600	800	6,3	475620	83,00

Cesta expositora de rejilla circular 3 niveles

3 level circular mesh display basket
Panier de présentation grillagé circulaire à 3 niveaux

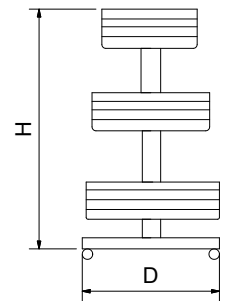

D	H	Kg	Barcode	€
700	1.280	9,0	475630	179,00

Portaprecios en varilla inox con pincho

Stainless steel price-holder rod with spike
Porte-prix en tige inox avec broche

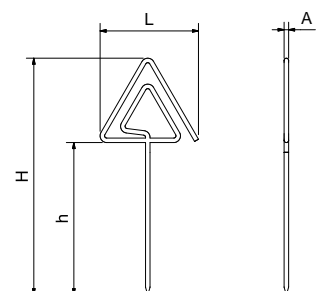

L	A	H	h	Gr	Barcode	€
60	6	160	100	25	081850	4,00



Portaprecios en varilla inox

Stainless steel price-holder rod
Porte-prix en tige inox

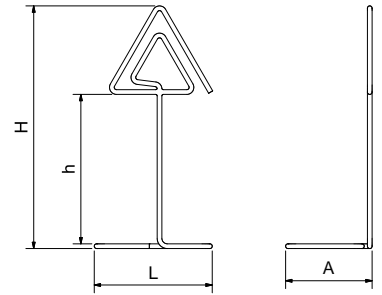

L	A	H	h	Gr	Barcode	€
75	55	165	95	35	081860	8,00

Envasadora al vacío

Vacuum packaging machine
Machine d'emballage sous vide



Motor de alta calidad.
120 W.
800 mbar.
Ancho máximo de bolsa 320 mm.
Interruptor con doble protección.
Bandeja de goteo extraíble.
Cutter integrado.
Silenciosa.

Su potente motor de 120 W y 800 mbar de presión, realiza el vacío sin esfuerzo creando un sello hermético que conserva la frescura y prolonga la vida útil de los alimentos.

Ya sea un cocinero doméstico o un chef profesional, nuestra envasadora al vacío es el complemento indispensable para su cocina, destacando su potencia, eficacia, sencillez de uso y de limpieza.

High-quality motor.
120 W.
800 mbar.
Maximum bag width 320 mm.
Double protection switch.
Removable drip tray.
Integrated cutter.
Silent.

Its powerful 120W motor and 800 mbar pressure vacuum seals effortlessly, while creating an airtight seal that preserves freshness and extends the shelf life of food.

Whether you're a home cook or a professional chef, our vacuum sealer is a key accessory to your kitchen, boasting power, efficiency, ease of use, and cleaning.

Moteur de haute qualité.
120 W.
800 mbar.
Largeur maximale du sac 320 mm.
Interrupteur avec double protection.
Plateau d'égouttage amovible.
Cutter intégré.
Silencieux.

Son moteur puissant de 120W et sa pression de 800 mbar réalisent la mise sous vide sans effort, créant une étanchéité hermétique qui préserve la fraîcheur et prolonge la durée de conservation des aliments.

Que vous soyez un cuisinier amateur ou un chef professionnel, notre machine sous vide est un complément indispensable à votre cuisine, offrant puissance, efficacité, facilité d'utilisation et de nettoyage.



L	H	Gr	Kg	Barcode	€
200	300		1,01	480292	39,00
250	350	100	1,07	480294	57,00
300	400		1,39	480296	84,00

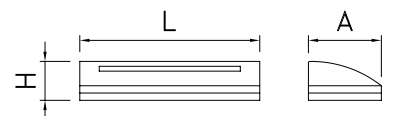

L	A	H	Potencia Power Puissance	Tensión Voltage Tension	Frecuencia Frequency Fréquence	Largo de sellado Sealing length Longueur de scellage	Máxima depresión Max depression Max dépression	Succión l/min. Double pump suction Suction de la pompe double	Kg	Barcode	€
400	170	115	120 W	220-240 V	50 Hz.	320	800 mbar	13 lt/min.	2,20	480288	105,00

Envolvedora de sobremesa

Desktop wrapping machine
Machine à envelopper de bureau



Machine d'emballage sur table pour film étirable
Découpage de film par résistance de coupe rétractable.
Plaque d'étanchéité antiadhésive avec contrôle automatique de la température.
Clignotants de l'état de la résistance à la coupure, l'étanchéité et le fonctionnement général de l'appareil.
Protection contre les charges électrostatiques.
Construction solide: tôle d'acier inoxydable et en aluminium anodisé.

APPLICATIONS:
Largement utilisé pour l'emballage des produits directement sur des plateaux en carton, polyéthylène, PVC rigide, etc.
MAXIMUM LARGEUR DU FILM 450 MM.

Máquina de envolver de sobremesa para film estirable.
Corte de film por resistencia escamoteable.
Plancha de sellado antiadherente con regulación automática de temperatura.
Indicadores luminosos del estado de la resistencia de corte, sellado y funcionamiento general de la máquina.
Protección contra cargas estáticas.
Sólida fabricación: chapa de acero inoxidable y aluminio anodizado.

APLICACIONES: Aplicable para envolver directamente los productos sobre bandejas de cartón, polietileno, PVC rígido, etc.

FILM UTILIZABLE:
Bobina de film extensible de 450 mm.

Worktop wrapping machine for stretch film.
Film cut by retractable cutter resistance.
Nonstick sealing hotplate with automatic temperature control.
Indicator lights for the status of the cutting resistance, the sealing and the general operation of the device.
Protection against electrostatic charges.
Solid construction: Stainless steel sheet and anodized aluminum.

APPLICATIONS: Extensively used for packing products directly on consumable trays in carton, polyethylene, rigid PVC, etc.
MAXIMUM FILM: Width 450mm.

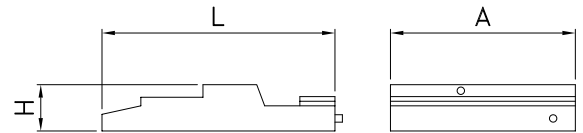

L	A	H	Potencia Power Puissance	Tensión Voltage Tension	Frecuencia Frequency Fréquence	Kg	Barcode	€
600	500	180	300 W	220-240 V	50-60 Hz.	3,5	480270	250,00

Cierra bolsas inox

Stainless steel bag closer
Scelleuse des sachets en acier inoxydable



Para cinta de 12 mm.

For packing tape 12mm.

Pour du ruban d'emballage 12mm.

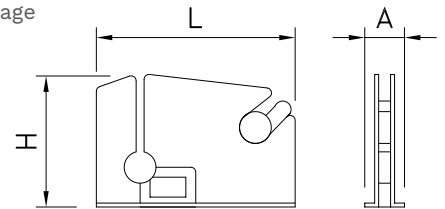

L	A	H	Gr	Barcode	€
220	75	150	350	480274	27,00

Parking para mascotas en acero inoxidable

Pets parking in stainless steel
Parking pour animaux de compagnie en acier inoxydable

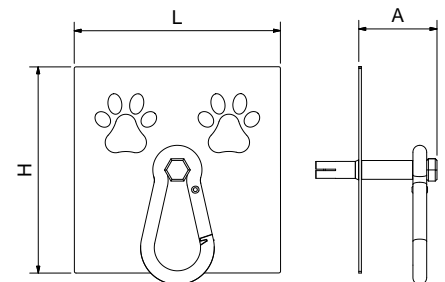

L	A	H	Kg	Barcode	€
120	45,50	120	0,26	082670	22,00
240			0,51	082672	34,00

Máquina termoselladora para bolsas de 400 mm.
Heat sealer for bags of 400 mm.
Machine à sceller pour sacs de 400 mm.

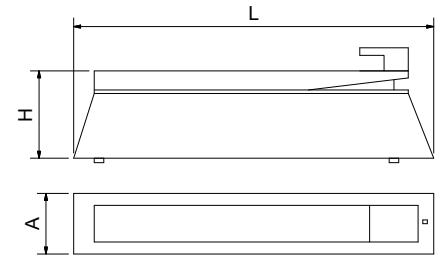

L	A	H	Potencia Power Puissance	Frecuencia Frequency Fréquence	Tensión Voltage Tension	Kg	Barcode	€
560	95	170	470 W	50/60 Hz	220 V	2,90	480298	137,00

Parking soporte para aparcamiento de bicicletas en acero inoxidable
Bike parking stand in stainless steel
Parking à vélos en acier inoxydable

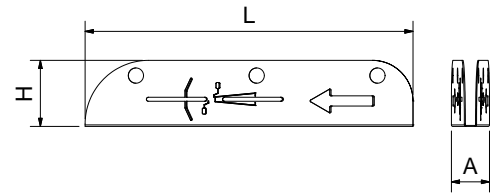

L	A	H	Kg	Barcode	€
645	69	130	2,75	084610	54,00

Paragüero inox
Umbrella stand
Porte-parapluies

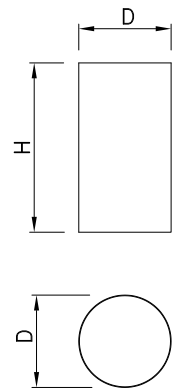

D	H	Kg	Barcode	€
300	550	3,4	481440	91,00

Soporte dispensador de bolsas de paraguas
Umbrella bag dispenser column support
Support distributeur de sacs pour parapluie

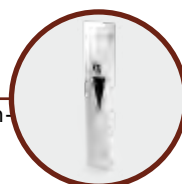
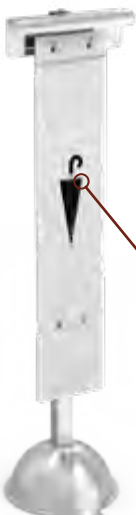

464648 € 15,00 200

Bolsas de paraguas para dispensador - 200 ud.
Umbrella bags for dispenser - 200 pc
Sacs pour parapluie pour distributeur - 200 pc

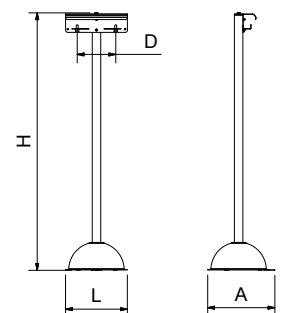

L	A	H	D	Gr	Barcode	€
290	315	1.208	90-215	350	064650	122,00

Perchero

Clothes stand
Portemanteau

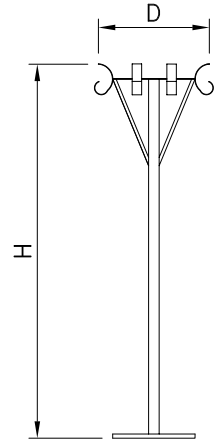

D	H	Kg	Barcode	€
390	1.700	8,0	481444	249,00

Perchero mural de acero inoxidable

Stainless steel wall-mounted coat peg
Portemanteau mural en acier inoxydable

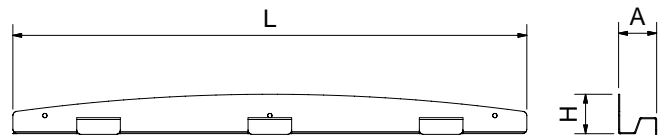

L	A	H	Kg	Barcode	€
708	55	55	0,9	081460	25,00

Percha industrial de acero inoxidable

Stainless steel industrial hanger
Cintre industrielle en acier inoxydable



Características:

Totalmente construida en acero inoxidable.
Soldadura de alta resistencia.
Ideal para gimnasios, piscinas, vestuarios colectivos, lavanderías, etc.
Diseño renovado que permite colgar delantales y prendas con tirantes.

Characteristics:
Wholly made in stainless steel.
High resistance welding.
Excellent for gymnasiums, swimming pools, dressing-rooms, laundries, etc.
New design that allows to hang up aprons and garments with shoulder straps.

Caractéristiques:
Entièrement construit en acier inoxydable.
Soudure en haute résistance.
Excellente pour gymnases, piscines, établissements de bains, blanchisseries, etc.
Dessin renouvelé qui permet prendre des tabliers et vêtements à épaulettes.

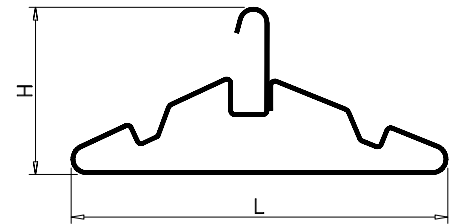

L	H	Gr	Barcode	€
420	190	120	081450	11,00

Set colgador sujeta-palos

Handle-holder kit
Kit porte-manches



L	A	H	Gr	Barcode	€
330	85	55	500	481208	24,00

Pictogramas en acero inoxidable
Stainless steel pictograms
Pictogrammes en acier inoxydable

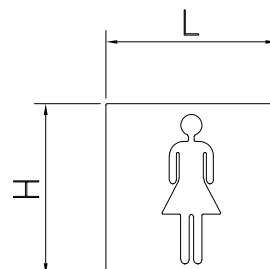



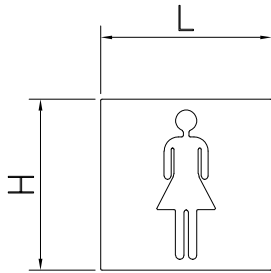





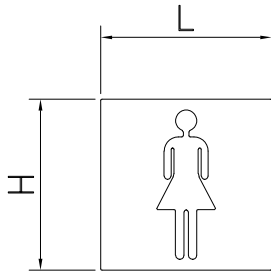





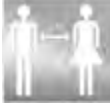

	L	H	Gr	Barcode	€
	120	120	175	082604	9,00
Aseo Mujer Women restroom Toilette femme					
	120	120	175	082602	9,00
Aseo Hombre Men restroom Toilette homme					
	120	120	175	082618	9,00
Aseo familiar Family toilet Toilette familial					
	120	120	175	082616	9,00
Cambia-Bebes Baby changing room Chambre bébés					
	120	120	150	082666	9,00
Tercera edad Senior people Personnes âgées					
	120	120	175	082634	9,00
Aseo unisex Unisex toilet Toilette unisexe					
	120	120	175	082614	9,00
Aseo Discapitados Disabled restroom Toilette handicapés					
	120	120	139	082668	9,00
Ascensor Lift Ascenseur					
	120	120	175	082620	9,00
Vestuario/Guardarropa Dressing room or cloakroom Vestiaire ou garde-robe					
	120	120	175	082636	9,00
Duchas Shower Douche					
	120	120	175	082628	9,00
Botiquín First aid box Boîte de secours					



	L	H	Gr	Barcode	€	
	Restaurante Restaurant Restaurant	120	120	175	082630	9,00
	Información Information desk Point d'information	120	120	175	082626	9,00
	Dirección Direction Direction	120	120	175	082612	9,00
	Permitido fumar Smoking allowed Permet de fumer	120	120	175	082608	9,00
	Prohibido fumar No smoking Défense de fumer	120	120	175	082606	9,00
	Prohibido No trespassing Interdit	120	120	175	082610	9,00
	Prohibido el paso No trespassing Passage interdit	120	120	175	082622	9,00
	Prohibido animales No Animals Animaux interdit	120	120	175	082624	9,00
	Prohibido el uso de teléfono No mobile phone Portable interdit	120	120	175	082632	9,00
	Zona Wifi Wifi zone Wifi Zone	120	120	175	082638	9,00
	Cafetería Coffee shop Cafétéria	120	120	175	082640	9,00
	Parking Parking Parking	120	120	175	082642	9,00
	Carros Shopping carts Caddies	120	120	175	082644	9,00
	WC WC WC	120	120	175	082664	9,00
	Uso obligatorio de mascarilla Mandatory mask Utilisation obligatoire du masque	120	120	133	082678	9,00
	Mascarilla Mask Masque	120	120	141	082680	9,00





	L	H	Gr	Barcode	€
 Guantes Gloves Gants	120	120	145	082682	9,00
 Puesto de gel hidroalcohólico Hydroalcoholic gel station Station de gel hydroalcoolique	120	120	148	082684	9,00
 Termómetro Thermometer Thermomètre	120	120	147	082686	9,00
 Desinfección de calzado Shoes disinfection Désinfection des chaussures	120	120	140	082688	9,00
 Espere tras la línea Do not cross the line Attendez derrière la file	120	120	126	082690	9,00
 Distancia de seguridad Safety distance Distance de sécurité	120	120	123	082692	9,00
 Número 0 Number 0 Numéro 0	60	120	70	082646	9,00
 Número 1 Number 1 Numéro 1	60	120	70	082648	9,00
 Número 2 Number 2 Numéro 2	60	120	70	082650	9,00
 Número 3 Number 3 Numéro 3	60	120	70	082652	9,00
 Número 4 Number 4 Numéro 4	60	120	70	082654	9,00
 Número 5 Number 5 Numéro 5	60	120	70	082656	9,00
 Número 6 Number 6 Numéro 6	60	120	70	082658	9,00
 Número 7 Number 7 Numéro 7	60	120	70	082660	9,00
 Número 8 Number 8 Numéro 8	60	120	70	082662	9,00
 Número 9 Number 9 Numéro 9	60	120	70	082658	9,00

Columna señalización con cinta
 Belt barrier post
 Colonne de signalisation avec bande

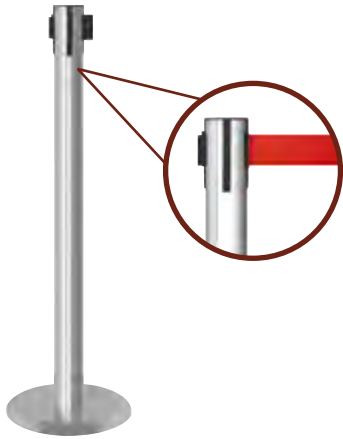

Características:
 Acero inoxidable AISI201
 Cinta de 1,8 metros.

Characteristics:
 Stainless Steel AISI201
 1,8 meter ribbon.

Caractéristiques:
 Acier inoxydable AISI201
 Ruban de 1,8 mètres.

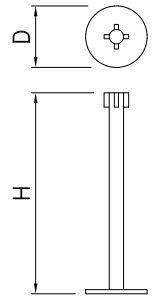

D	H	Kg	Barcode	€
320	910	5,5	481446	55,00

Cinta mural extensible de señalización
 Extendable wall tape for signaling
 Ruban mural extensible de signalisation



Características:
 Cinta de 2 metros.

Characteristics:
 2 meter ribbon.

Caractéristiques:
 Ruban de 2 mètres.

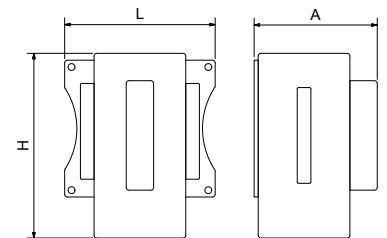

L	A	H	Kg	Barcode	€
110	90	135	0,38	481448	37,00

Visor su turno con mando
 Queuing ticket screen with remote controlled
 Écran pour file d'attente avec commandé



480850 65,00

Mando inalámbrico de repuesto
 Replacement wireless control
 Commande sans fil de remplacement



L	A	H	Potencia Power Puissance	Tensión Voltage Tension	Frecuencia Frequency Fréquence	Kg	Barcode	€
275	55	240	6 W	220-240 V	50-60 Hz.	4,50	480811	275,00

Dispensador de tickets su turno
 Queuing ticket dispenser
 Distributeur de tickets file d'attente



480809 4,00

Rollo 2.000 tickets su-turno
 Roll of 2000 queue tickets "My turn"
 Rouleau de 2000 tickets pour file d'attente

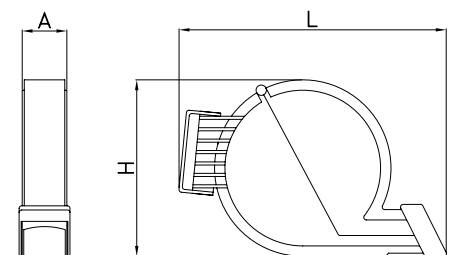
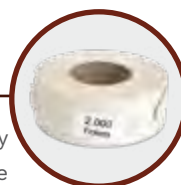

L	A	H	Kg	Barcode	€
265	45	175	0,32	480810	21,00

Columna de acero inoxidable para dispensadores
 Stainless-steel stand for dispensers
 Stand en acier inoxydable pour distributeurs

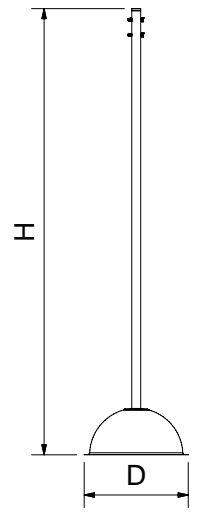

D	H	Kg	080430	€
290	1.245	9,00	080430	118,00

Columna inoxidable con dispensador "Su turno"
 Stainless floor stand for queuing ticket dispenser
 Pied inoxydable avec distributeur "votre Tour"

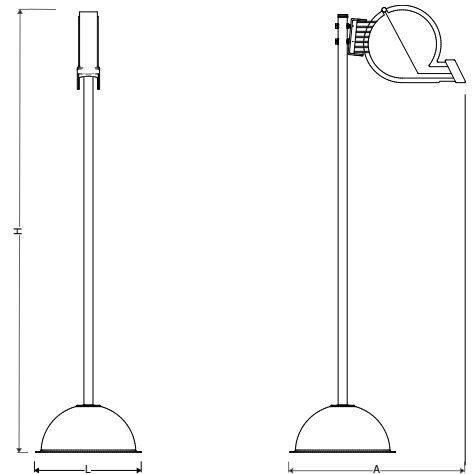

L	A	H	Kg	080432	€
290	422	1.245	9,32	080432	155,00

Equilibrador
 Spring balancer
 Equilibrateur



Características:
 Equilibrador para uso intermitente.
 Capacidad regulable y dispositivo de limitación de carrera.
 Cuerpo de chapa metálica.
 Longitud del cable: 1000 mm.
 Capacidad de 0,5 - 1,5 kilos.

Characteristics:
 Spring balancer for uncontinuous use.
 Adjustable capacity with stroke limitation device.
 Metallic sheet body.
 Cable length: 1000 mm.
 Capacity from 0,5 - 1,5 kg

Caractéristiques:
 Equilibrateur pour usage intermittent.
 Capacité réglable et dispositif de limitation de vitesse.
 Boîtier en tôle métallique.
 Longueur du câble : 1000 mm
 Capacité de 0,5-1,5 Kg

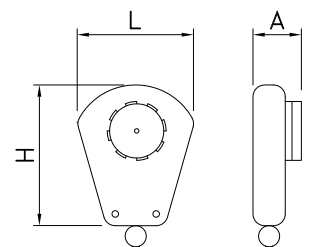
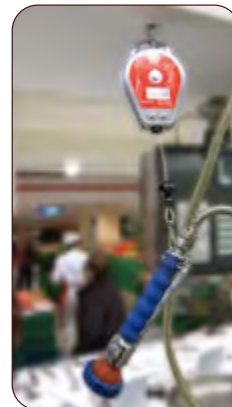

L	A	H	Gr	463030	€
100	55	120	500	463030	70,00

Taburete inox regulable en altura

Adjustable stainless steel stool
Tabouret inox réglable

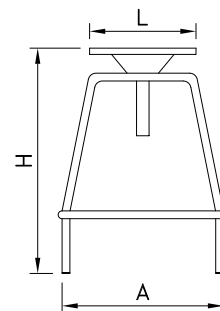

L	A	H	H _{int}	Kg	Barcode	€
350	550	850	600	4,8	482206	252,00

Escalones inox

Inox stairs
Marche inox

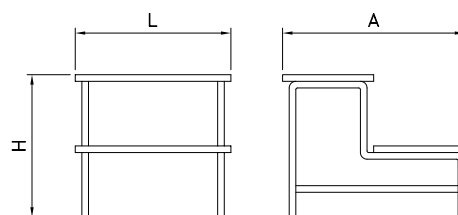

L	A	H	Kg	Barcode	€
470	550	430	1,50	482208	180,00

Taburete rodante profesional en acero inoxidable

Sloping wall rack shelf
Étagère murale inclinée pour paniers de lavage

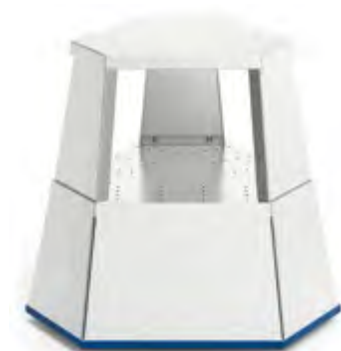

Características:

Construido totalmente en acero inoxidable, este taburete profesional móvil de 2 peldaños garantiza a los usuarios una superficie robusta, estable y segura donde alzarse.

Dispone de 3 ruedas retráctiles para un cómodo desplazamiento mientras no está en uso, mientras que cuando el usuario lo utiliza, éste se adhiere al suelo con firmeza para evitar movimientos no deseados.

Gracias a estar fabricado en acero inoxidable, a diferencia de los taburetes del mercado, nuestro taburete es ideal para su utilización en ambientes hostiles, como industria alimentaria en general, industria cárnica, salas frías, salas de despiece, obradores, laboratorios... En resumen, cualquier estancia que precise una higiene rigurosa ya que es fácil de limpiar y desinfectar, incluso con hidrolimpiadora.

Characteristics:

This professional two steps stainless steel kick stool guarantees to users a robust, stable and safe surface to step onto.

It is supplied with three retractable wheels for easy moving while not in use, whereas it adheres firmly to the ground to prevent unwanted movements when in use.

Made in of stainless steel and thus especially recommended for general food industry (meat industry, cold rooms, laboratories...) or elsewhere with strict hygiene is required, by contrast to most of the step stools on the market.

Caractéristiques:

Fabriqué en acier inoxydable, ce tabouret professionnel mobile à 2 marches garantit aux utilisateurs une surface robuste, stable et sûre où monter.

Il dispose de 3 roues rétractables pour un déplacement confortable lorsqu'il n'est pas utilisé, tandis que lorsque on l'utilise, il adhère fermement au sol pour éviter tout mouvement indésirable.

Grâce à sa fabrication en acier inoxydable, contrairement à d'autres modèles sur le marché, notre tabouret est idéal pour une utilisation dans l'industrie alimentaire en général, industrie de la viande, chambres froides, laboratoires... Bref, toute pièce nécessitant une hygiène rigoureuse.

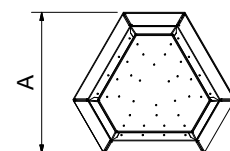
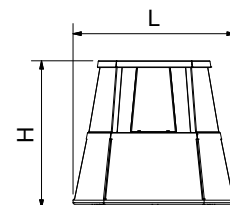

L	A	H	Kg	Barcode	€
479	416	435	5,50	082220	220,00

Taburete con ruedas
Rolling step-stool
Tabouret marche - pied roulant



€
482250 5,80

Rueda de repuesto para taburetes.
Spare wheel for step-stools.
Rouelle de rechange pour tabouretes.

Características:

Este taburete metálico lleva en su base tres ruedas que permiten su fácil traslado de un sitio a otro con un simple empujón del pie, sin embargo en el momento en que usted sube sobre él queda totalmente fijado al suelo gracias a su burlete circular que se adhiere como una ventosa.

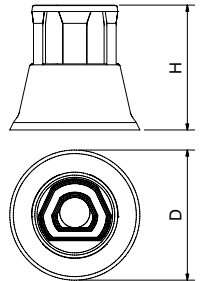

Characteristics:

This metallic stool has on its base three castors that allow moving it from one place to another easily, just pushing it with your foot. Furthermore, whenever you are standing on it, it is firmly fixed to the floor, as if it were a suction pad, thanks to its rounded rubber strip.

Caractéristiques:

Ce tabouret métallique a dans sa base trois rouelles qui permettent le déplacer facilement de long en large, avec un seul poussé du pied. En plus, lorsqu'on monte sur lui, il reste totalement fixé au sol, comme une ventouse, grâce à sa bande ronde en caoutchouc.

D	H	Kg		€
			482202	
430	430	4,6	482204	69,00
			482212	

Losetas antideslizantes
Non-slip floor tiles
Caillebotis anti-dérapant

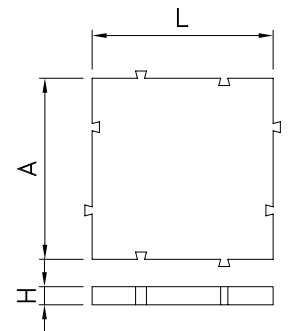

L	A	H	Kg	€
500	500	25	1,10	481040 16,00
500	500	50	1,73	481042 24,00
1.000	500	50	3,35	481044 51,00

Rampa loseta
Floor slat ramp
Rampe pour caillebotis

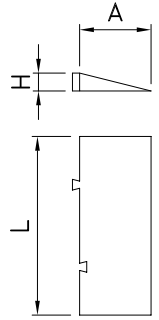

L	A	H	Gr	Barcode	€
500	200	50	565	481046	24,00

Palet encajable enrejado
Open deck nestable standard pallet
Palette grillagée emboîtable



Novedad
NEW
PRODUCT



L	A	H	Kg	Barcode	€
1.200	1.000	140	9,00	481024	29,00

Palet encajable de plástico liso
Stackable plastic closed pallet
Palette en plastique emboîtable lisse



Características:
Superficie de apoyo: 9 patas.
Material: HDPE.

Characteristics:
Support points: 9 legs.
Material: HDPE.

Caractéristiques:
Surface d'appui: 9 plots.
Matériel: HDPE.

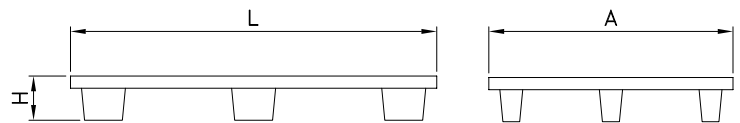

			Carga dinámica Dynamic load Charge dynamic	Carga estática Static load Charge statique			€
L	A	H	Kg	Kg	Kg	Barcode	
1.200	800	140	1.000	2.000	6,30	481020	29,00
1.200	1.000	140	1.200	2.000	8,00	481021	35,00



Europalet higiénico reforzado
Heavy duty hygienic Euro pallet
Euro palette hygiénique renforcé



Características:

Superficie superior e inferior completamente lisa para una fácil limpieza.

Rebordes perimetrales antideslizantes.

Material: Polietileno de alta densidad en calidad alimentaria.

Posibilidad de insertar un chip.

Caractéristiques:

Plateaux supérieur et inférieur complètement lisses pour nettoyage aisé.

Rebords anti-glissement.

Matériau: polyéthylène haute densité pour l'industrie alimentaire.

Possibilité d'intégrer une puce.

Characteristics:

Upper and lower deck completely sealed for hygiene.

Non-slipping raised edges.

Material: High density polyethylene for food industry.

Possibility of integrating micro-chip.

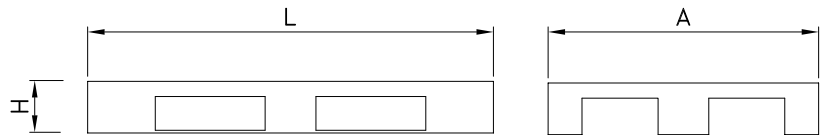

			Carga dinámica Dynamic load Charge dynamic	Carga estática Static load Charge statique			
L	A	H	Kg.	Kg.			€
1.200	800	160	1.000	5.000	18,0	481002	168,00

Plataforma rodante
Rolling platform
Plate-forme roulante



Características:

4 ruedas giratorias de nylon.

Carga max. 250 kgrs.

Material: PPC.

Characteristics:

4 castors in nylon.

Max. 250 kg.

Material: PPC.

Caractéristiques:

4 roulettes en nylon.

Max. 250 kg.

Matière: PPC.

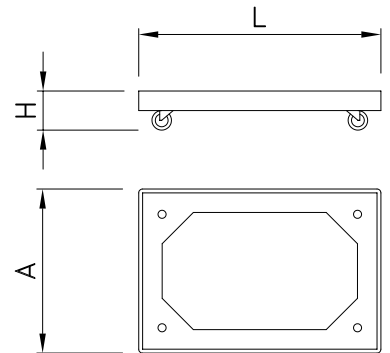

***HASTA 250 Kg**
Up to 250 kgs of load strength
Jusqu'à 250 kgs de résistance

L	A	H			€
610	410	161	3,00	481060	70,00

Plataforma con freno para transporte de cestos de lavavajillas
Dishwasher rack cart with brake
Plate-forme pour transport de paniers de lave-vaisselle

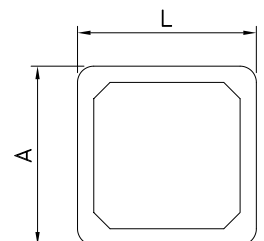

L	A			€
550	550	2,65	483016	87,00

Transpaleta de acero inoxidable

Stainless steel pallet truck
Transpalette en acier inoxydable



Características:

Capacidad: 2000 kilos.

Todas las piezas están hechas de acero incluyendo bomba hidráulica, marco tenedor, manija, barra de empuje, teniendo, pasador y tornillo, etc. Para su uso en la carne y otros de la industria alimentaria, conservera de productos lácteos y todas las áreas donde se utilizan ácidos corrosivos y soluciones salinas. Rodillos / ruedas: Nylon.

Characteristics:

Capacity: 2000 kg

All its parts are made in stainless steel, included the hydraulic pump, the fork frame, the handle, the pulling bar, the dowel and the screw, etc.

Specially for dairy, canning and meat industries and for food industry in general. Recommended for usage with corrosive acids and saline solutions. Rollers / wheels: nylon.

Caractéristiques:

Capacité : 2000 kg

Toutes les pièces sont en acier y compris pompe hydraulique, cadre, manette, barre de poussée, verrou, vis. Etc.

Usage pour la viande et autre industrie alimentaire, industrie laitière et dans les domaines où l'on utilise des acides corrosifs et solutions salines. Rouleaux/roulettes nylon.

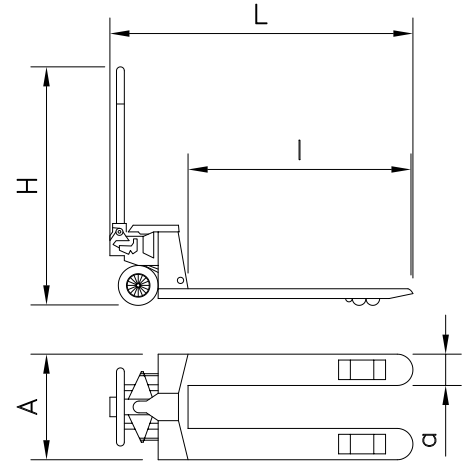

L	A	H	I	a	Kg	Barcode	€
1.550	540	1.220	1.150	160	75,00	480228	3.320,00

Transpaleta pintada

Pallet truck in painted steel
Transpalette peinte



Características:

Capacidad: 2.500 kg.

Kit de sellado especial para prolongar la vida útil de la bomba. Horquillas reforzadas para mayor resistencia. Ruedas de entrada y salida en nylon para facilitar su movimiento. Bujes sin aceite en puntos clave para su manejo con menor fuerza y para alargar la vida de la transpaleta en general.

Characteristics:

Capacity: 2,500 kg

Special sealing kit for an extended life of the pump.

Reinforced forks for greater resistance.

Nylon entry and exit wheels for easy moving

Oil-free bushings at key points for an effortless handling and to extend the life of the pallet truck as a whole.

Caractéristiques:

Capacité: 2500 kg

Kit d'étanchéité spécial pour prolonger la durée de vie de la pompe.

Fourches renforcées pour une plus grande résistance.

Roulettes d'entrée et de sortie en nylon pour un mouvement facile.

Douilles sans huile aux points clés pour une manipulation avec moins de force et pour prolonger la durée de vie du transpalette en général.

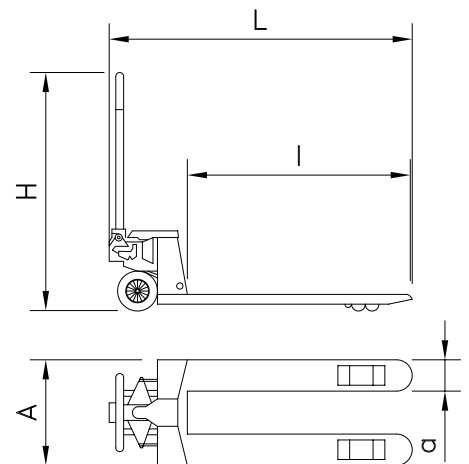

L	A	H	I	a	Kg	Barcode	€
1.550	540	1.220	1.150	160	78,00	480229	750,00

Carro porta barriles de cerveza en acero inoxidable
 Stainless steel beer barrel trolley
 Chariot porte baril de bière en acier inoxydable

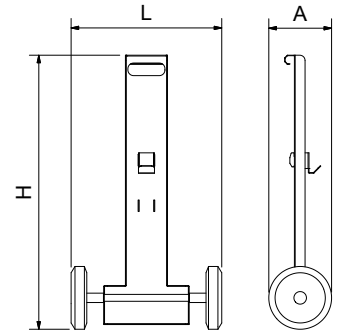

L	A	H	Kg	084620	€
480	200	875	6,0	084620	117,00

Cutter combi (Metal detectable)
 Combi cutter knife Metal detectable
 Cutter avec métal détectable combi



Juego de cuchillas de repuesto.
 Spare scraper blades.
 Jeu de lames de réchange.

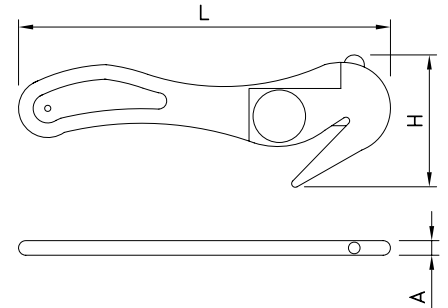
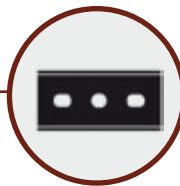

L	A	H	Gr	481254	€
260	4	185	72	481254	21,00

Cortina de lamas de PVC
 PVC strip curtain
 Ride aux à lanières en PVC

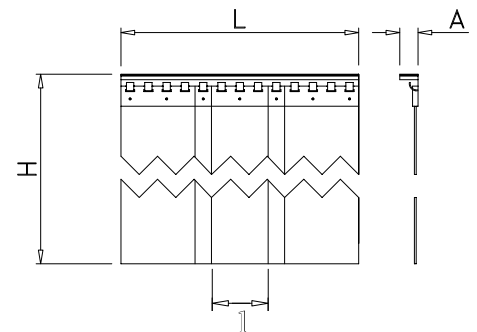

L	A	H	I	Kg	082460	€
984	40	2.000	200	1,35	082460	150,00

Buzón de acero inoxidable apertura superior
 Mailbox in stainless steel, top loading
 Boîte aux lettres en acier inoxydable avec ouverture supérieure



Novedad
 NEW
 INNOVATION

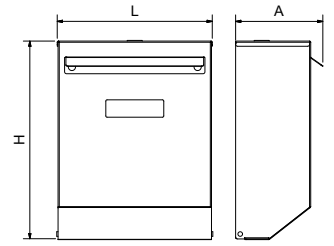

L	A	H	Kg	Barcode	€
238	137	304	1,65	083274	49,00

Pincho antipalomas en acero inoxidable
 Stainless steel deterrent spikes for pigeons
 Tige anti-pigeons en acier inoxydable

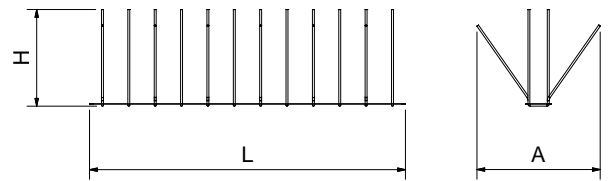
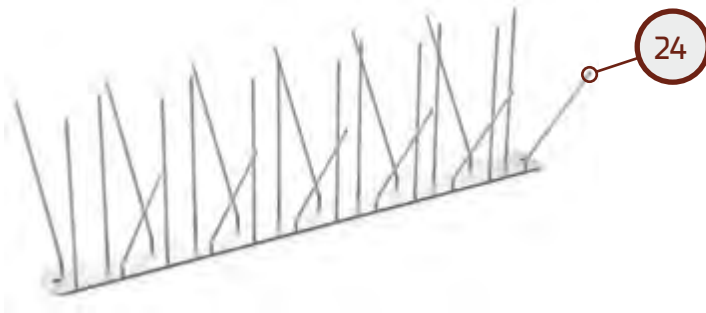

L	A	H	Gr	Barcode	€
490	191	150	350	084602	21,00

Marquesina para puertas
 Canopy for doors
 Auvent pour portes

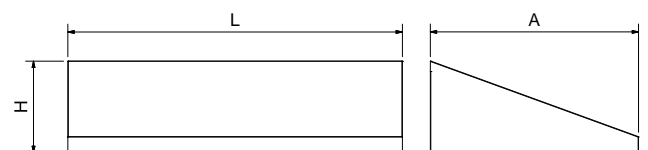

L	A	H	Kg	Barcode	€
1.270	347	790	10,88	083270	323,00

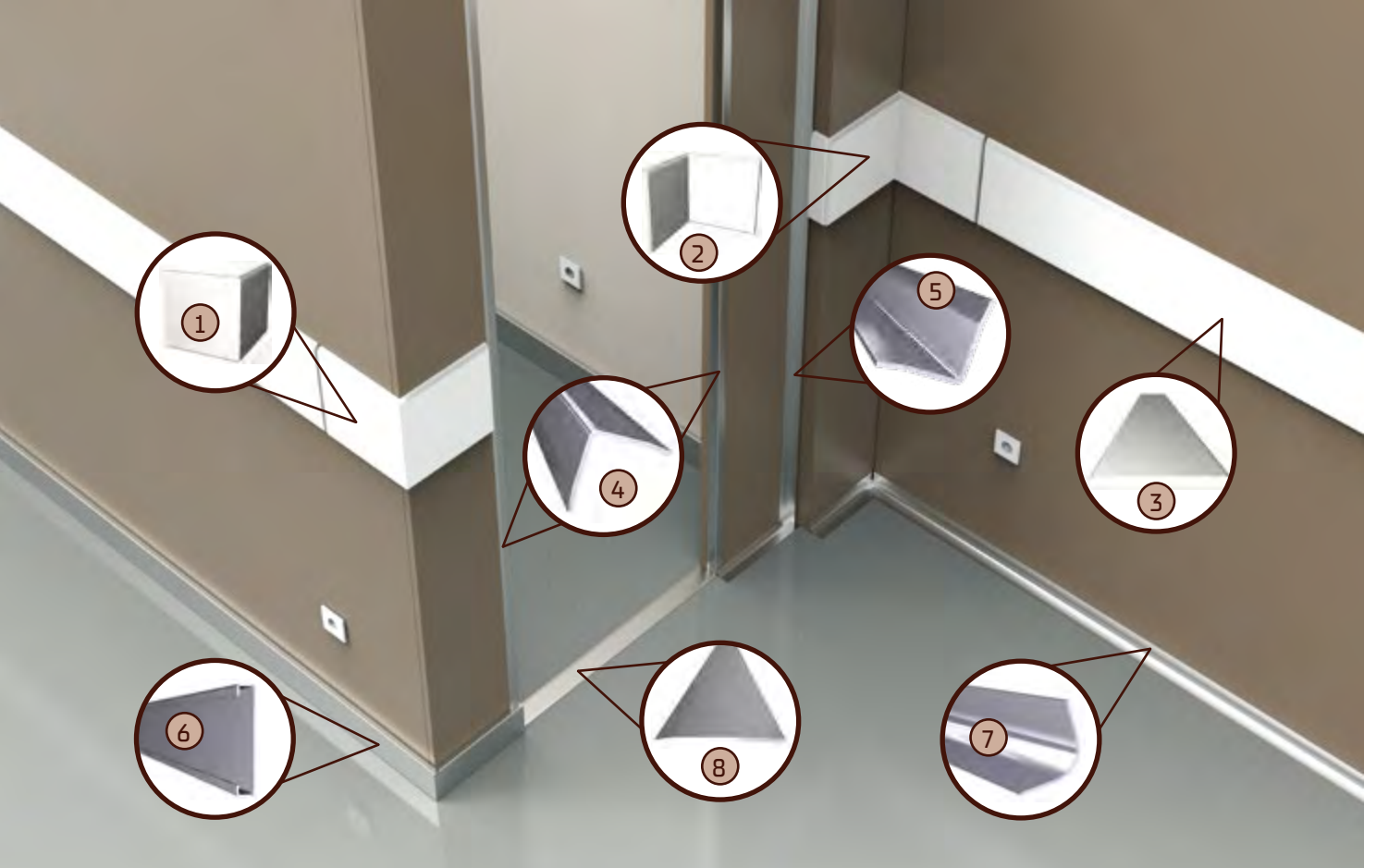

Perfil paragolpes ángulo exterior de fibra blanca
 White polyethylene wall protection buffer for exterior angle
 Pare-chocs mural d'angle extérieur en fibre blanche

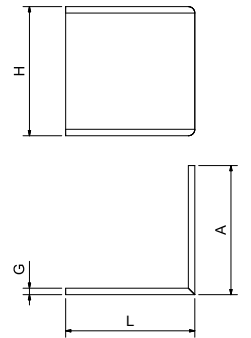

L	A	H	G	Gr	Barcode	€
200	200	200	10	80	434020	22,00

Perfil paragolpes ángulo interior de fibra blanca
 White polyethylene wall protection buffer for interior corner
 Pare-chocs mural d'angle intérieur en fibre blanche

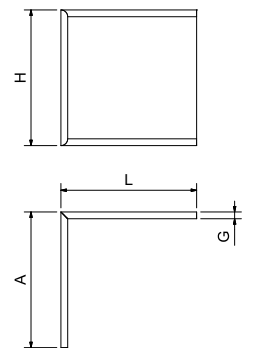
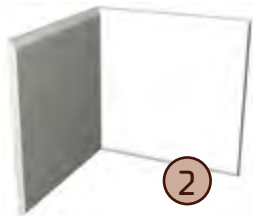

L	A	H	G	Gr	Barcode	€
200	200	200	10	80	434022	22,00

Perfil paragolpes recto de fibra blanca
 Straight white polyethylene fender plinth
 Pare-chocs mural en fibre blanche

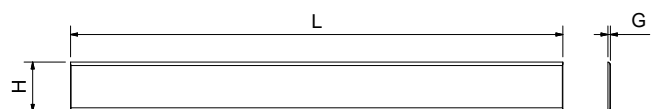

L	H	G	Gr	Barcode	€
2.000	200	10	400	434024	45,00

Guardavivos exterior de acero inoxidable

Stainless steel external corner guard
Baguette d'angle externe en acier inoxydable

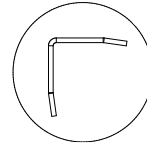
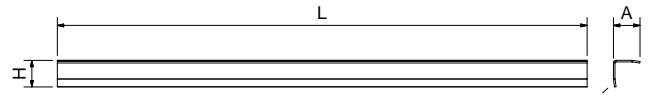

L	A	H	Kg	Barcode	€
2.000	25	25	1,20	083220	20,00
3.000	25	25	1,73	083222	44,00

Guardavivos interior de acero inoxidable

Stainless steel internal corner guard
Baguette d'angle interne en acier inoxydable

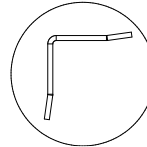
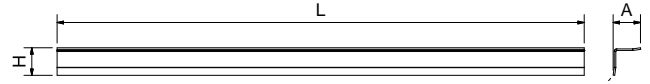

L	A	H	Kg	Barcode	€
2.000	25	25	1,20	083230	20,00
3.000	25	25	1,73	083232	25,00

Zócalo de acero inoxidable

Stainless steel skirting board
Plinthe en acier inoxydable

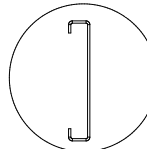
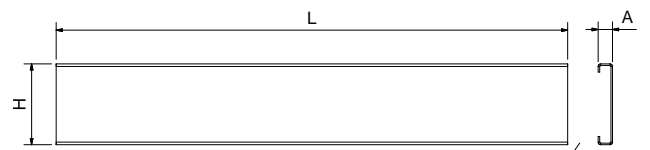

L	A	H	Kg	Barcode	€
2.000	14	79	2,67	083240	35,00
3.000	14	79	4,10	083242	40,00

Zócalo curvo de acero inoxidable

Stainless steel curved corner guard
Baguette d'angle en acier inoxydable courbe

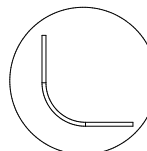
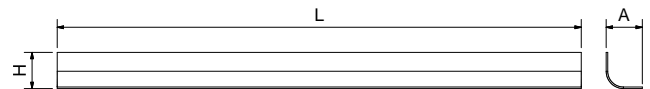

L	A	H	Kg	Barcode	€
2.000	35	35	1,50	083250	35,00
3.000	35	35	2,25	083252	44,00

Tapajuntas de acero inoxidable

Stainless steel cover strip
Barre de seuil en acier inoxydable

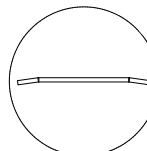
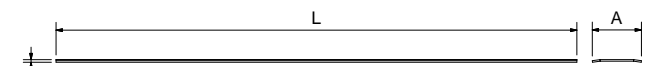

L	A	H	Kg	Barcode	€
2.000	47	3	1,20	083260	22,00
3.000	47	3	1,73	083262	44,00

Perfil paragolpes curvo mural de plástico

Plastic wall bumpers
Pare-chocs mural en plastique

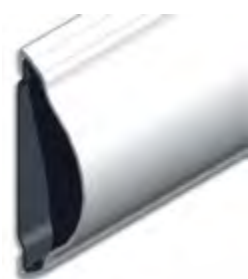

L	A	H	Gr	Barcode	€
3.000	55	100	400	482470	24,00
30	38	100	40	482472	3,25

Consigna para carros con taquilla

Left-trolleys with locker

Consigne pour caddies avec casier

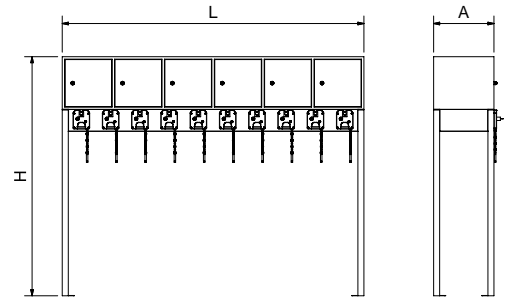

L	A	H		Kg		€
850	418	1.650	5	30,90	081428	1.323,00
2.000	400	1.590	10	40,00	081432	2.111,00

Consigna para carros

Left-shopping trolleys

Consigne pour caddies

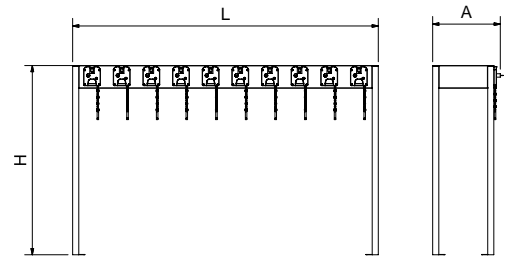

L	A	H		Kg		€
850	418	1.240	5	9,90	081426	788,00
2.000	400	1.240	10	24,00	081430	1.481,00

Consigna mural para carros

Wall left-shopping trolleys

Consigne mural pour caddies

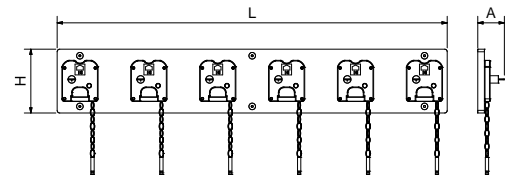

L	A	H		Kg		€
1.185	81	194	6	8	081434	518,00

Taquilla - Consigna

Left-shopping - Lockers

Casiers - Consigne

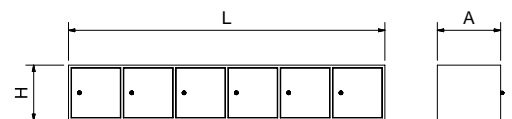













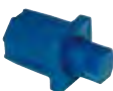

L	A	H		Kg		€
850	400	410	3	21	481437	573,00
2.000	400	350	6	16	481436	1.145,00

Repuestos y complementos

Spare part and complements

Rechange et compléments

		Gr		€
	Cerradura Lock Serrure	41	481404	5,50
	Cerradura maestra Master lock Serrure master	41	481405	8,50
	Llave maestra para cerraduras Master key for locks Clé passe-partout pour serrures	10	481402	4,10
	Cerradura de retorno de monedas Coin operated lock Serrure à monnaies	790	→ 481410	59,00
			← 481412	
	Montaje de la cerradura de retorno de monedas (no incluye cerradura) Assembly coin operated lock (lock not included in this price) Assembleur serrure à monnaies (serrure n'inclus pas dans ce prix)		081452	34,00
	Pomo articulado Articulated handle Poignée articulée	80	481406	13,00
	Candado para pomo articulado Padlock for articulated handle Cadenas poignée articulée	105	481408	23,00
	Juego de herrajes para puertas (para 2 puertas) Sliding doors fixtures set (valid for two doors) Set de ferrures pour portes coulissantes (valide pour deux portes)	85	073850	70,00
	Taco regulable Adjustable blocks Taquets réglables	45	409851	1,50
	Taco regulable altura especial Special height adjustable blocks Taquets réglables hauteur spéciale	115	409848	3,00
	Juego de llaveros numerados del 1 al 6 Set of keyrings, numbered from 1 to 6 Ensemble de porte-cl-es numérotés de 1 à 6	30	481438	3,00
	Juego de placas numeradas del 1 al 6 Set of plates, numbered from 1 to 6 Ensemble de plaques numérotées de 1 à 6	20	481439	2,50
	Cerradura con cadena para consigna de carros Locker with chain for left-shopping trolleys Serrure avec chaîne pour consigne pour caddies	850	481430	66,00
	Cerradura electrónica para taquilla Electronic lock for lockers Serrure électronique pour la porte vestiaire	584	→ 481418	81,00
			← 481419	
	Montaje cerradura electrónica en puerta de taquilla (no incluye cerradura) Installation of electronic lock for lockers (lock not included) Montage serrure électronique sur porte de vestiaire (la serrure n'est pas incluse)		081454	32,00



Cenicero con soporte y depósito de arena

Ashtray with support and tray for sand
Cendrier avec support et plateau pour sable



Características:

Cenicero de gran resistencia en acero inoxidable.
Dispone de un depósito para llenarse con arena u otra sustancia inerte no inflamable para facilitar el apagado de los cigarrillos.

Characteristics:

Stainless steel heavy duty.
Provided with a tray to be filled with sand or another not inflammable substance to make easier the extinguishing of cigarettes.

Caractéristiques:

Cendrier à haute résistance en acier inoxydable.
C'est pourvu avec un plateau pour le remplir avec sable ou autre substance inerte non inflammable pour faciliter l'extinction des cigarettes.

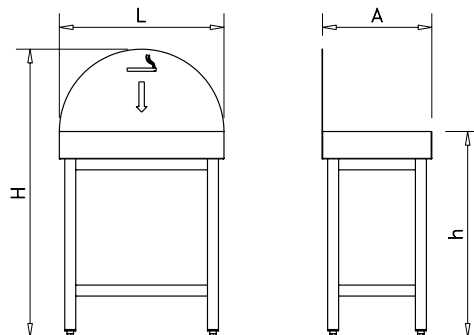

L	A	h	H	Kg	Barcode	€
600	400	750	1.050	16,6	080650	495,00

Cenicero papelera

Ashtray - wastepaper bin
Cendrier - poubelle inox



Características:

Dos usos en un mismo espacio.
Totalmente fabricada en acero inoxidable, está diseñada para usarla en exteriores.
Incorpora recipiente GN 1/3 de profundidad 65 mm.
Desmontable para su vaciado y limpieza. Posibilidad de lavado a máquina.
Papelera provista de anillas para una mejor y más cómoda colocación de sacos y bolsas.

Characteristics:

Double use within the same space.
Wholly made of stainless steel, it has been thought for external use.
With a container GN 1/3 - 65 mm. depth
Detachable for emptying and cleaning. It can be washed in the dish washer.
Wastepaper provided of rings to put the bags inside easily.

Caractéristiques:

Deux utilisations, même espace.
Entièrement en acier inoxydable. Il est possible son utilisation à l'extérieur.
Avec un récipient GN 1 / 3 - 65 mm profondeur.
Detachable pour la vidange et le nettoyage. Il peut être lavé dans le lave-vaisselle.
Corbeille à papier munie des anneaux pour mettre les sacs à l'intérieur facilement.

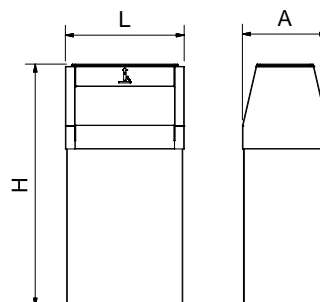

L	A	H	liters	Kg	Barcode	€
360	258	733	44 lts	6,5	080658	305,00

Caperuza porta-cenicero para papelera

Balanced swing top with ashtray for waste bin
Couvercle inox basculant avec cendrier pour poubelle



Características:

Convierte la papelera basculante en un cenicero-papelera. Dos usos en un mismo espacio.
Totalmente fabricada en acero inoxidable, está diseñada para usarla en exteriores.
Incorpora recipiente GN 1/3 de profundidad 65 mm.
Desmontable para su vaciado y limpieza. Posibilidad de lavado a máquina.

Characteristics:

Transformez votre poubelle basculante en une poubelle cendrier. Deux utilisations, même espace.
Entièrement en acier inoxydable. Il est possible son utilisation à l'extérieur.
Avec un récipient GN 1 / 3 - 65 mm profondeur
Detachable pour la vidange et le nettoyage. Il peut être lavé dans le lave-vaisselle.

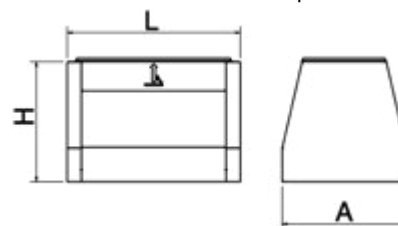

Caractéristiques:

Turn your swing waste bin into a waste bin-ashtray. Double use within in the same space.
Wholly made of stainless steel, it has been thought for external use.
With a container GN 1/3 - 65 mm. depth
Detachable for emptying and cleaning. It can be washed in the dish washer.

L	A	H	Kg	Barcode	€
360	258	260	1,9	080659	140,00

Cenicero para espacios reducidos de pie

Floor-mounted ashtray for reduced spaces
Cendrier inox pour espaces réduits sur pied



Características:

Construido totalmente en acero inoxidable. Su diseño permite ocupar el mínimo espacio en el interior o exterior de su negocio. Diseñado para colocarse en cualquier rincón, incluso detrás de una puerta. Depósito de agua interior para el mejor apagado de los cigarrillos. Desmontable para su vaciado y limpieza. Posibilidad de lavado a máquina.

Characteristics:

Wholly made of stainless steel, it has been thought to occupy little space both in indoor and outdoor areas. It can be installed anywhere in your shop, even behind the door. Inner water tank to put out cigarettes easily. Detachable for emptying and cleaning. It can be washed in the dish washer.

Caractéristiques:

Entièrement en acier inoxydable, il a été conçu pour occuper peu de place à l'extérieur et à l'intérieur. Il peut être installé n'importe où dans votre magasin, même derrière la porte. Réservoir d'eau intérieur pour éteindre les cigarettes facilement. Détachable pour la vidange et le nettoyage. Il peut être lavé dans le lave-vaisselle.

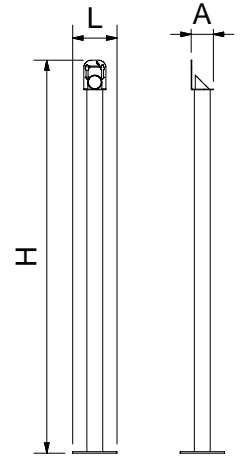

L	A	H	Kg	Barcode	€
120	60	1.064	2,3	080654	135,00

Cenicero para espacios reducidos

Ashtray for reduced spaces
Cendrier inox pour espaces réduits



Características:

Diseñado para colocarse en cualquier rincón, incluso detrás de una puerta. Depósito de agua interior para el mejor apagado de los cigarrillos. Desmontable para su vaciado y limpieza. Posibilidad de lavado a máquina.

Characteristics:

It can be installed anywhere in your shop, even behind the door. Inner water tank to put out cigarettes easily. Detachable for emptying and cleaning. It can be washed in the dish washer.

Caractéristiques:

Il peut être installé n'importe où dans votre magasin, même derrière la porte. Réservoir d'eau intérieur pour éteindre les cigarettes facilement. Détachable pour la vidange et le nettoyage. Il peut être lavé dans le lave-vaisselle.

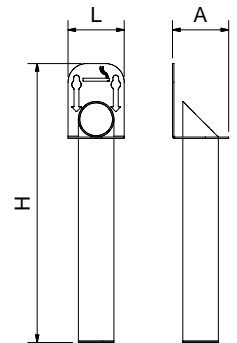

L	A	H	Kg	Barcode	€
60	60	298	0,4	080652	86,00

Cenicero mural NF

NF wall mounted ashtray
Cendrier mural NF



Características:

Perfecto para exteriores.

Fácil fijación a pared.

Desmontable para su limpieza y vaciado. Posibilidad de introducirlo en máquinas de lavado.

Characteristics:

Ideal for outside
Easy to install.
Detachable for emptying and cleaning. It can be washed in the dish washer.

Caractéristiques:

Ideal pour l'extérieur, mais il peut être utilisé aussi à l'intérieur.
Facile à installer
Détachable pour la vidange et le nettoyage. Il peut être lavé dans le lave-vaisselle.

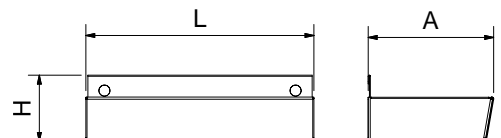

L	A	H	Kg	Barcode	€
207	114	60	0,36	080656	21,00

Cajones
Drawers
Tiroirs



Cajón
Drawer
Tiroir

Características:

Cajones totalmente contruidos en acero inoxidable, acabado brillante. Los rodamientos de nylon en sus guías garantizan un estable movimiento de apertura y cierre, aun cuando esté cargado. Interior y exterior embutidos para aumentar su resistencia. Diseño elegante.

Characteristics:

Drawers completely made of stainless steel polished finished. Its nylon bearing in the rails guaranty a stable opening-closing movement, even when loaded. Hammered inside and outside to increase its strenght. Smart design.

Caractéristiques:

Tiroirs totalement construit en acier inoxydable avec finition brillant. Les roulements de nylon dans ses glissières garantissent le mouvement équilibré d'ouverture et de fermeture bien qu'il soit chargé. Intérieur et extérieur embouti pour augmenter sa résistance. Dessin élegant.



Cajón con cerradura
Lock drawer
Tiroir avec serrure

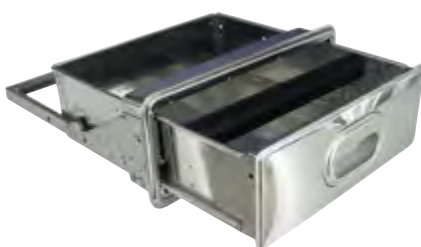

Cajón con golpeador para posos de café
Drawer with striker for coffee grounds
Tiroir avec dispositif pour faire tomber le marc de café



Cajón alto
Deep drawer
Tiroir haut

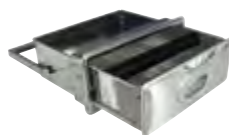
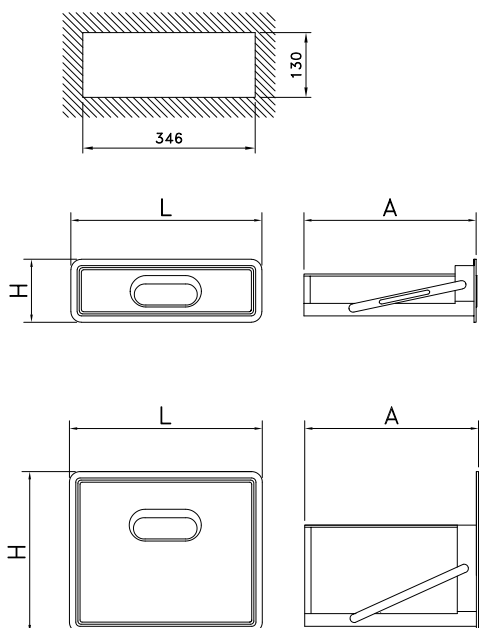

L	A	H	Kg	Barcode	€
375	405	160	2,8	485402	155,00
375	405	160	2,9	485404	204,00
375	405	160	3,0	485406	184,00
470	495	410	5,2	485414	390,00

Cajón o tolva acoplado a estantería

Drawer or hopper coupled to shelves

Tiroir ou trémie accouplé aux étagères



Estanterías ancho 500 mm Shelving units depth 500 mm Rayonnages profondeur 500 mm		Estanterías ancho 600 mm Shelving units depth 600 mm Rayonnages profondeur 600 mm	
---	--	---	--



€



€

	085430	293,00	085432	297,00
	085434	340,00	085436	344,00
	085438	303,00	085440	308,00
	085468	510,00	085470	520,00



Los precios de esta sección incluyen el cajón, el envoltente, los refuerzos y la mano de obra de acoplar a nuestros estantes.

Fringe, reinforcements, drawer and shelf fixing labour are included in the price.

Enveloppant, renforts, tiroir et la main d'œuvre pour les fixer aux étagères c'est inclus dans le prix.

Cajón o tolva preparado para acoplar a estantería por el cliente

Drawer or hopper designed to be coupled to shelves by the user

Tiroir ou trémie dessiné pour être accouplé aux étagères par l'utilisateur



Estanterías ancho 500 mm Shelving units depth 500 mm Rayonnages profondeur 500 mm		Estanterías ancho 600 mm Shelving units depth 600 mm Rayonnages profondeur 600 mm	
---	--	---	--

Composición Composition Composition		Composición Composition Composition	
---	--	---	--

Unidades Units Unitées	Barcode	€	Unidades Units Unitées	Barcode	€
------------------------------	---------	---	------------------------------	---------	---



€



€

	1	085410	281,00	1	085410	281,00
	2	085418		2	085420	
	1	085412	331,00	1	085412	331,00
	2	085418		2	085420	
	1	085414	300,00	1	085414	300,00
	2	085418		2	085420	
	1	085464	534,00	1	085464	534,00
	2	085418		2	085420	



Estos cajones y tolvas están especialmente diseñados para ser acoplados mediante tornillos o remaches a nuestras estanterías. Los precios incluyen el cajón, el envoltente y los refuerzos necesarios para su fácil adaptación al estante.

These screw or rivet fixing drawers and hoppers are specially designed to be easily adapted to our shelves. Fringe, reinforcements, drawer and shelf fixing labour are included in the price.

Ces tiroirs et trémies de fixation par visés ou rivetages ont été dessinés par une facile adaptation à l'étagère. Enveloppant, renforts, tiroir et la main d'œuvre pour les fixer aux étagères c'est inclus dans le prix.



Cajón o tolva acoplado

Drawer or hopper coupled
Tiroir ou trémie accouplé



Los precios de esta sección incluyen el cajón, la mano de obra y los materiales necesarios para acoplar estos elementos a los muebles que precisen. Usualmente se suelen acoplar en tajos de troceo, fregaderos, mesas de trabajo, etc.

The prices shown in this section include the drawer plus the labour as well as the necessary materials to couple these elements in the provided furniture. Usually they are coupled in shelves, chopping blocks, sinks, preparation tables, etc.

Les prix de ce partie comprennent le tiroir plus la main-d'oeuvre et les matériels nécessaires pour accoupler ces éléments à les meubles qu'ils aient besoin. Usuellement ils sont accouplés sur rayonnages, hachoirs à viande, eviers, tables de préparation, etc.

Cajón o tolva preparado para acoplar por el cliente

Drawer or hopper designed to be coupled by the user
Tiroir ou trémie dessiné pour être accouplé par l'utilisateur



Estos cajones y tolvas están especialmente diseñados para ser acoplados mediante tornillos o remaches. Incorporan un envolvente taladrado en sus pestañas superiores de tal manera que puede adaptarse a cualquier mesa del mercado.

The screw or rivet fixing drawers and hoppers are provided with a stainless steel fringe pierced in the upper part in order to be adapted to any table.

Les tiroirs et trémies de fixation par vises ou rivetages incorporent un enveloppant en acier inoxydable perforé dans ses languettes supérieures tellement qu'il est possible l'adapter à quelque table.

Modelo Model Model		€
	085402	254,00
	085404	290,00
	085406	261,00
	085408	332,00
	085460	526,00
	085480	200,00
	085482	282,00

Modelo Model Model		€
	085410	220,00
	085412	285,00
	085414	254,00
	085464	488,00
	085490	170,00
	085492	232,00

Tolva abatible para posos de café

Hinged hopper for coffee grounds
Trémie à un abattant pour marc de café

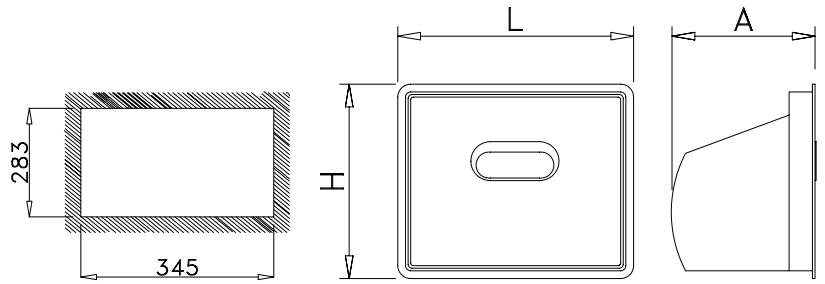

L	A	H	Kg	Barcode	€
370	240	303	3,53	485408	249,00

Puerta

Door
Porte

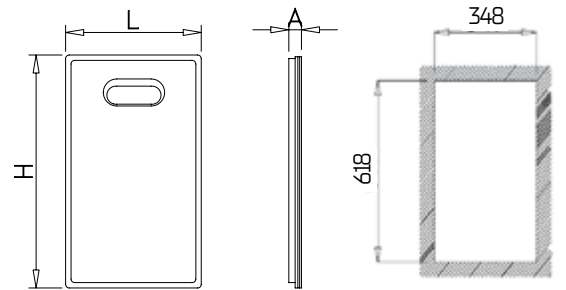

L	A	H	Kg	Barcode	€
373	35	643	6,8	485602	204,00

Repuesto golpeador de posos de café

Spare striker for coffee grounds
Dispositif de remplacement pour faire tomber le marc de café

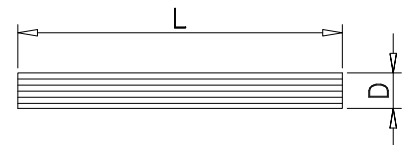
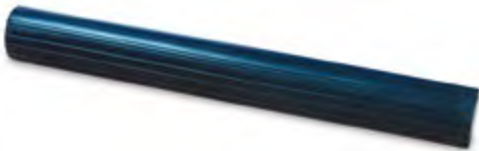

L	D	Kg	Barcode	€
320	40	1,85	485410	44,00

Kit golpeador para cajón pequeño

Coffee grounds striker kit for small drawer
Barre pour petit tiroir de marc à café

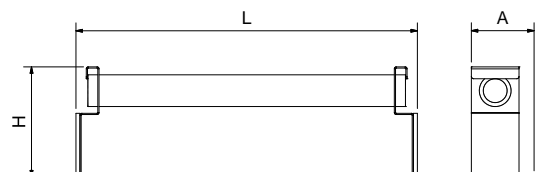

L	A	H	Kg	Barcode	€
430	79	139	2,5	2720108	42,00

⚠️ Valido solo para cajones Fricosmos.
Valid only for Fricosmos drawers.
Valable uniquement pour les tiroirs Fricosmos.



Características:

Disponemos de dos tipos de rueda: una más económica, cuya estructura está fabricada en acero galvanizado, siendo su superficie rodante de goma, y otra construida en acero inoxidable, con su superficie rodante de nylon. El acero inoxidable y el nylon ofrecen una duración y resistencia garantizada, por lo que son ideales para mataderos, salas de despiece y demás sitios donde el grado de humedad sea elevado.

Characteristics:

Two sort of wheels are available: an economic one, which structure is made in galvanized steel, with a rolling surface in rubber, an another one made in stainless steel with its rolling surface in nylon. The stainless steel and the nylon offer a guaranteed length and resistance, and because of this, they are ideal for slaughterhouses, cutting up rooms, workshops, and places with high humidity concentration.

Caractéristiques:

Il y a deux types de rouelles, une plus économique, dont structure est fabriquée en acier galvanisé avec une surface roulante de caoutchouc, l'autre construite en acier inoxydable avec sa surface roulante en nylon. L'acier inoxydable et le nylon offrent une durée et résistance garanties, ce qui fait que ce soit idéal pour abattoirs, salles d'équarriment, ateliers et autres lieux avec une haute concentration d'humidité.

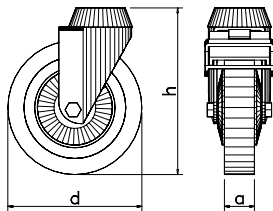

Inox - Nylon

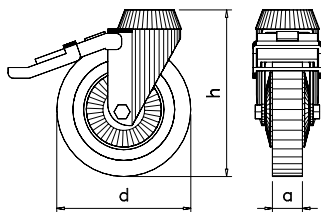

Galvanizadas
Goma



							Resistencia por rueda Castor load strength Résistance de charge par rouelle	
d	a	h	Kg	Gr	Barcode	€		
80	33	106	100	570	485032	25,00		
130	40	157	180	890	485036	39,00		
80	33	106	100	810	485030	33,00		
130	40	157	180	1.140	485034	53,00		
75	23	94	50	300	485004	8,00		
125	32	155	100	725	485012	17,00		
75	23	94	50	370	485002	9,00		
125	32	155	100	800	485010	21,00		

							Resistencia por rueda Castor load strength Résistance de charge par rouelle	
d	a	h	Kg	Gr	Barcode	€		



Rueda anticalórica con freno en acero inoxidable ø100 mm
Heat resistant swivel wheel with brake in stainless steel ø100 mm
Roulette résistante à la chaleur avec frein en acier inoxydable ø100 mm



175 Kg. -40 a 280°C 840 485026 **70,00**



Rueda anticalórica en acero inoxidable ø100 mm
Heat resistant swivel wheel in stainless steel ø100 mm
Roulette résistante à la chaleur en acier inoxydable ø100 mm



175 Kg. -40 a 280°C 840 485028 **55,00**

Ruedas acopladas

Coupled wheels
Rouelles accouplées



- El precio comprende el montaje de 4 ruedas por elemento. El precio de las ruedas no está incluido.

The price includes the assembly of 4 castors per element. The price of the castors is not included.

Le prix comprend l'assemblage de 4 rouelles par élément. Le prix des rouelles c'est ne pas compris.

Características:

Este apartado les será útil si lo que desean es acoplar ruedas a algún artículo de nuestro catálogo. Generalmente las ruedas suelen ser acopladas en estanterías, tajos de troceo, fregaderos, mesas, etc. La forma de aplicar los precios es sumar el precio de la rueda deseada mas el acoplamiento. Por ejemplo, tenemos una mesa que necesitamos que lleve ruedas y queremos obtener el precio de las ruedas colocadas. En primer lugar tendríamos que seleccionar una rueda entre las disponibles y en este caso seleccionamos la de acero inoxidable con freno de 80 mm de altura. La operación sería la siguiente:
4 ruedas del código 485030 + 4 acoplar rueda a pata de 40x40 mm código 085002.

Characteristics:

This part will be useful if what you wish is to assembly wheels to any article of our catalogue. Wheels are usually coupled in shelves, chopping blocks, sinks, tables, etc. The way of applying prices is to add the price of each one of the required wheels plus the assembly. For example, if you need a table with wheels and you want to obtain the price of the wheels assembled, first you should select one of the available wheels. In the case that you select the one in stainless steel of 80 mm height with brake, the result is as follows:
4 wheels code 485030 + assembly wheel to 40x40 mm leg code 085002.

Caractéristiques:

Cette partie vous sera d'utilité si vous desirez accoupler rouelles a quelque article de notre catalogue. En général les rouelles coutume d'être accouplées en rayonnages, hachoirs à viande, évier, tableaux, etc. La forme d'appliquer les prix c'est ajouter le prix du rouelle désirée plus le prix de l'accouplement. Par exemple, si vous avez besoin d'un tableau avec rouelles et vous voulez obtenir le price des rouelles couplées, d'abord vous devriez sélectionner une rouelle entre les disponibles. Dans le cas de sélectionner celle d'acier inoxydable de 80 mm d'hauf avec frein, l'opération serait la suivante:
4 rouelles du code 485030 + accoupler rouelle dans empiètement 40x40 mm code 085002.

		€
Acoplar rueda a soporte de estantería Assembly wheel to shelving support Accoupler rouelle dans support de rayonnage	085004	10,00
Acoplar rueda a pata de 40x40 mm. Assembly wheel to 40x40 mm. leg Accoupler rouelle dans empiètement de 40x40 mm.	085002	22,00
Acoplar ruedas a soporte para mostrador de pescadería Assembly of castors to fish counter support Assemblage de rouelles au support d'étal à poisson	085008	50,00
Acoplar ruedas a boxes modulares Assembly of castors to modular boxes Assemblage de rouelles au boxes modulaires	085010	50,00
Acoplar ruedas a palet de jamones/embutidos Assembly of castors to palet for cured hams/ sausages and cured meat Assemblage de rouelles au palette pour jambons/ charcuterie	085012	94,00

Kit de acoplamiento a rueda

Wheel fixing kit
Kit d'accouplement aux rouelle



Características:

Con este producto usted podrá acoplar las ruedas del catálogo a nuestros artículos.

Characteristics:

This article will enable the fixing of any wheel of the catalogue to our products.

Caractéristiques:

Cet article vous permettra la fixation de quelque rouelle du catalogue à nos produits.

Gr	€
200 085006	12,00

Adaptador enchufe tipo G

Type G plug adapter

Adaptateur pour prise électrique type G



Tensión Voltage Tension	Frecuencia Frequency Fréquence	Gr	Barcode	€
220 V	50 Hz	56	485878	8,00

Taco regulable para soporte de estantería

Adjustable block for shelving support

Taquet réglable pour supports de rayonnage



Características:

Material altamente resistente. Rosca interior reforzada.
Cumplen con todas las normativas.
Para ángulo de 40x40x2 mm (Soportes estanterías)

Characteristics:

High resistance material, since it has a reinforced internal thread.
It complies all the current norms.
For angled bars 40x40x2 mm

Caractéristiques:

Matériel d'haute résistance, puisqu'il a une filet intérieur renforcée. Il accomplit toutes les normes en vigueur.
Pour bars en angle de 40x40x2 mm

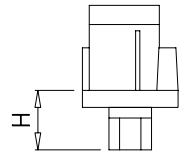

Gr	H ₁	H ₂	Barcode	€
45	28	50	411018	2,78

Tacos regulables para tubo

Adjustable blocks for tube

Taquets réglables pour tube



Características:

Material altamente resistente. Al llevar rosca interior cumplen con todas las normativas vigentes.

Characteristics:

High resistance material. Since it has thread inside, is in accordance with all the current norms.

Caractéristiques:

Matériel d'haute resistance. Puisqu'il a une filet intérieur, il accomplit toutes les normes en vigueur.

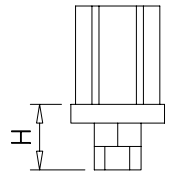

Para tubo de For tube of Pour tube de	Gr	H ₁	H ₂	Barcode	€
40x40x1 mm	45	28	50	409851	1,50
40x40x1,5 mm					
Ø 38x1,5 mm	40	35	60	409852	4,10

Taco regulable altura especial para tubo

Special height adjustable block for tube

Taquet réglable hauteur spéciale pour tube

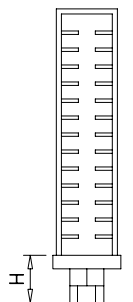

Para tubo de For tube of Pour tube de	Gr	H ₁	H ₂	Barcode	€
40x40x1 mm					
40x40x1,5 mm	115	30	105	409848	3,00

Tacos de plástico para tubo
 Plastic blocks for tube
 Taquets de plastique pour tube



Características:

Para tubo de 1 mm y 1.5 mm de espesor. Material altamente resistente. Las aletas dispuestas horizontalmente garantizan un máximo ajuste.

Characteristics:

High resistance material. The flaps horizontally disposed guaranty the maximum adjustment.

Caractéristiques:

Matériel d'haute resistance. Les ailettes ordonnées horizontalement garantissent le maximum ajustage.

Para tubo de For tube of Pour tube de	Gr	Barcode	€
20x10 mm	2	409812	0,16
20x20 mm	4	409810	0,18
25x25 mm	5	409808	0,19
30x30 mm	8	409806	0,22
40x20 mm	6	409804	0,24
40x30 mm	9	409803	0,27
40x40 mm	11	409802	0,32

Para tubo de For tube of Pour tube de	Gr	Barcode	€
Ø 20 mm	3	409886	0,17
Ø 25 mm	4	409888	0,18
Ø 30 mm	5	409890	0,20
Ø 35 mm	8	409892	0,24
Ø 38 mm	9	409894	0,25
Ø 42 mm	10	409896	0,26

Funda antivibradora para taco regulable

Antivibrator cover for adjustable blocks
 Base anti-vibrateur pour taquets réglables

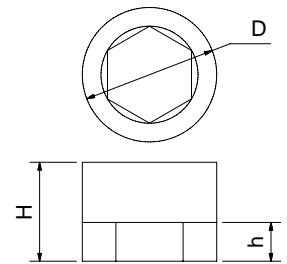
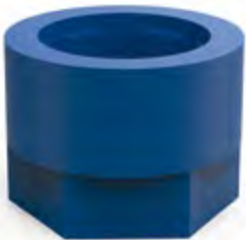

D	H	h	Gr	Barcode	€
35	25	10	15	409952	1,31

Pasacable inox

Stainless steel grommet
 Passe-câbles en acier inoxydable

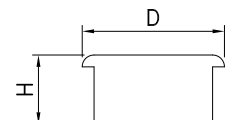

H	D	Gr	Barcode	€
35	72	90	409835	22,00

Aros para tolva de desbarasado

Rings for waste chutes
Cercles pour trémies à déchets

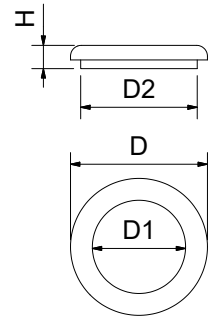

D	D1	D2	H		Gr		€
235	165	200	44		450	486402	20,00
235	165	200	44		450	486406	20,00
235	165	200	44		450	486408	20,00
235	165	200	44		450	486410	20,00
235	165	200	44		450	486412	20,00

Tapa para aro de tolva de desbarasado

Lid for Rings for waste chutes
Couvercle pour cercles pour trémies à déchets

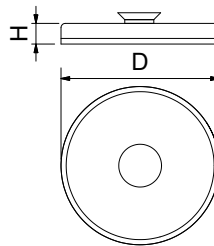

D	D1	H	Gr		€
240	180	26	265	486404	19,00

Limpiador de acero inoxidable

Stainless steel cleaner
Laveur d'acier inoxydable



Características:

Este producto de alta calidad tiene como principales ventajas su elevada evaporación y secado lo que proporciona una limpieza rápida, eficaz y duradera. No deja cercos ni restregones. Por su neutralidad no ataca el acero conservándolo en perfectas condiciones durante más tiempo.

Aplicación:

Este limpiador se recomienda para cualquier superficie de acero inoxidable.

Characteristics:

This high quality product has, as main advantage, a high degree of evaporation and drying, which provides a quick, effective and lasting cleaning. It does not leave any cleaning or rubbing traces. Because of its neutrality this product does not attack the steel and keeps it in perfect conditions for longer.

Use:

This cleaner is recommended for any kind of stainless steel surface.

Caractéristiques:

Ce produit d'haute qualité a comme principale avantage son élevé évaporation et séchage, ce qui rapporte un nettoyage rapide, effectif et durable. Ce ne fait pas traces des frottements. A cause de sa neutralité n'attaque pas l'acier et le conserve en parfait conditions pendant plus longtemps.

Applications:

On recommande ce nettoyeur pour quelque surface en acier inoxydable.



	Gr		€
1lts	850	380004	18,00

Spray de acero inoxidable

Stainless steel spray
Espray acier inoxydable



Reacondicionamiento de piezas de acero inoxidable, rejillas, tuberías, instalaciones exteriores, decoración, etc.

Es un revestimiento superficial, a base de pigmentos minúsculos de acero inoxidable y resina acrílica, que se adhiere a superficies metálicas, vidrio, madera, piedra, papel, plástico, etc. Soporta temperaturas de hasta 300°C durante periodos cortos. A las 4-6 horas después del secado es resistente a la abrasión y a agentes químicos.

Repairing of stainless steel parts, grills, pipes, outdoor installations, decorating, etc.

It is a superficial coating, from stainless steel and acrylic resin micro-pigments, which is adhered to metallic surfaces, glass, wood, stone, paper, plastic, etc. It supports temperatures up to 300°C for short periods. Between 4-6 hours after having dried, is abrasion and chemical agents resistant.

Aménagement des pièces en acier inoxydable, grillages, conduits, installations extérieures, décoration, etc.

C'est un revêtement superficiel, composé de micro pigments en acier inoxydable et résine acrylique, qui s'adhère aux surfaces métalliques, verre, bois, pierre, papier, plastic, etc.

Il supporte des températures jusque 300°C pendant périodes brèves. Après 4-6 heures de séchage c'est résistant à l'abrasion et aux agents chimiques.

	Gr		€
400 ml.	410	480002	14,00



ÍNDICE ANALÍTICO

ANALYTICAL TABLE OF CONTENTS
INDEX ANALYTIQUE

C

I

H

G

M

L



Índice analítico

Símbolos

10 W - Luz LED blanca (E27 x 135), 383
18 W - UV-A LED repuesto para exterminador LD120, 383
20 W - Luz negra (E27 x 160), 383

A

Abrazadera sin fin de 25-40 mm. para manguera, 332
Abre ostras de polietileno, 114
Abre ostras manual profesional en acero inoxidable, 114
Abrebotellas, 170
Abrelatas, 143
Abrelatas industrial, 144
Abrelatas tenaza, 143
Abreostras, 113
Abreostras profesional de sobremesa en acero inoxidable, 114
Abreostras sobremesa, 113
Acanalador, 129
Accesorios, 374
Accesorios para columnas de gel, 417
Accesorios para estanterías, 35
Accesorios para fuentes M 3/8", 214
Accesorios para grifos de manguera, 268
Accesorios para lavamanos portátiles autónomos, 192
Acoplamiento de grifo ducha serie basic a encimera, 276
Acoplar a estante fibra, 52
Acoplar a estante inox, 52
Acoplar portacuchillos, 74, 136, 138
Acoplar rueda a pata de 40x40 mm., 497
Acoplar rueda a soporte de estantería, 497
Acoplar ruedas a boxes modulares, 497
Acoplar ruedas a palet de jamones/embutidos, 497
Acoplar ruedas a soporte para mostrador de pescadería, 497
Adaptador de cestillos cuberteros para carros de servicio, 320
Adaptador de contenedores para carros de servicio, 320
Adaptador de cubetas GN 1/3 y 1/6 para carros de servicio, 320
Adaptador enchufe tipo G, 498
Adaptador enchufe tipo H, 384
Adaptador H de 1/2" a H de 1/2", 268
Adaptador H de 3/8" a M de 1/2", 268
Adaptador para cartucho 462828 y leva 462842, 281
Adaptador para mástil, 278
Adhesivo hierba., 332
Adhesivo modelo "Ola", 332
Adhesivo para pedal, 311, 388
Adhesivo para trampilla, 311, 388

B

Bacaladera, 113
Balanza de cocina digital 5 kg, 151
Balanza de cocina de precisión 0,1 g, 152
Balanza mecánica de cocina, 151
Balasto (Reactancia) para UK-240, 383
Balasto (Reactancia) para UK-40 y UK-80, 383
Banco de vestuario en acero inoxidable y polietileno, 350
Bandeja de aluminio con asas para pizza 6 porciones, 154
Bandeja de aluminio con mango para pizza 6 porciones, 154
Bandeja de camarero de acero inoxidable especial jarras de cerveza, 449
Bandeja de cambio, 450
Bandeja de cambio rectangular con clip, 450
Bandeja de cambio sencilla, 450
Bandeja de comedor autoservicio inox, 449
Bandeja de exposición para helados en vaso, 434

7 W - Bombilla UV-A LED repuesto para exterminadores LED, 383
8 W - UV-A LED repuesto para exterminador SP-80 LED, 383

Adhesivo Reciclaje, 392
Adhesivo reciclar Envases y plásticos, 392
Adhesivo reciclar Materia orgánica, 392
Adhesivo reciclar Papel y cartón, 392
Adhesivo reciclar Vidrio, 392
Adhesivo ventana, 375
Afilador cuchillos manual de sobremesa, 134
Afilador de cuchillos de sobremesa, 135
Afilador de cuchillos eléctrico mini, 135
Afilador de cuchillos profesional de sobremesa, 135
Afilador de cuchillos profesional, 135
Aguja de mechar, 127
Aireador cromado fijo para grifo, 260
Aireador cromado orientable para grifo, 260
Anillo acero inox antigoteo para botella de vino, 172
Aplasta hamburguesas circular, 93
Aplasta hamburguesas de molde ovalado, 94
Aplasta hamburguesas de molde redondo, 95
Aplasta hamburguesas higiénico doble, 94
Aplastafiletas, 131
Aplastafiletas circular, 131
Arandelas, 66
Armario con cerradura y puertas transparentes para medicamentos y utensilios, 346
Armario botiquín, 404
Armario de esquina derecha con puertas abatibles, 343
Armario de esquina izquierda con puertas abatibles, 343
Armario estantería 2 puertas, 345
Armario esterilizador de cuchillos mediante Ozono, 372
Armario inox esterilizador de utillaje y calzado, 373
Armario para equipos informáticos, 347
Armario para productos de limpieza, 344
Armarios de puertas abatibles, 342
Armarios de puertas correderas, 342
Armarios esterilizadores de cuchillos rayos U.V., 371
Aro azul con trampilla para contenedor de reciclaje vertical, 392
Aros para tolva de desbarasado, 500
Asa universal para cubetas Gastronorm, 446
Asiento abatible, 402
Atrapador de insectos Easy Trap, 381
Atrapador de insectos Tephri Trap, 381
Atril de acero inoxidable, 347

Bandeja de exposición para helados polos, 434
Bandeja de frío GN cold plate, 166
Bandeja de panadería acanalada en aluminio 600x400 mm., 451
Bandeja Euronorm autoservicio en polipropileno azul, 448
Bandeja Euronorm autoservicio en polipropileno azul con asas, 448
Bandeja Gastronorm de presentación BP3, 447
Bandeja inoxidable con asa, 448
Bandeja isotérmica polipropileno Euronorm 1/1 para colectividades 5 compartimentos, 449
Bandeja menú inoxidable, 448
Bandeja para marisco, 452
Bandeja pastelera en acero inoxidable, 451
Bandeja pastelera perforada, 451
Bandeja perforada para mostrador de pescadería, 332
Bandejas aluminio antiadherente, 450

Bandejas de camarero de acero inoxidable, 449
Bandejas de presentación, 447
Bandejas de presentación BP2, 447
Bandejas de presentación inox, 447
Barbacoa portátil profesional de sobremesa y acero inoxidable, 166
Barra de apoyo abatible. Anclaje a suelo, 402
Barra de apoyo mural horizontal, 402
Barra de apoyo mural horizontal pasamanos, 402
Barra de apoyo mural para bañera, 401
Barra de apoyo mural para lavabo, 401
Barra de apoyo mural vertical abatible, 401
Barra de apoyo recta, 401
Barra mural con ganchos, 49
Barra para colgar accesorios, 375
Barreños, 408
Base rodante galvanizada, 322
Bases inoxidables para transporte de pizzas, 157
Bastidor para carro de servicio, 321
Batidor, 141
Biberones de cocina, 149
Bidón apilable blanco 15L para fregadero autónomo, 201
Bidón apilable blanco 25L para fregadero autónomo, 201
Bidón apilable translúcido 20 lts para fregadero autónomo, 201

C

Cabezal para filtro 3M y CARBA (Futura fría, Cold+ y Enfriador de agua), 214
Cabezal para filtro Bestmax (Futura fría y caliente), 214
Cadena eslabón largo según norma DIN 763 ø5 A4, 52
Cafetera express inox, 175
Cafetera italiana tradicional 6 ó 12 tazas, 175
Caja alimentaria apilable, 457
Caja alimentaria apilable perforada para masa, 457
Caja apilable multiusos 65 L., 455
Caja de 10.000 guantes desechables (100 bolsas de 100 unidades), 400
Caja de 10.000 guantes desechables con agujero para colgar (100 bolsas de 100 unidades), 400
Caja de 50 fundas desechables para carro de Euronorm / Gastronorm, 325
Caja de reparto/distribución apilable con tapa, 176, 452
Cajón acoplado, 347
Cajón acoplado a estante 2/1 imagine, 30
Cajón alto, 492
Cajón con cerradura, 492
Cajón con golpeador para posos de café, 492
Cajón liso apilable gris, 455
Cajón liso especial para carne, 455
Cajón o tolva acoplado, 494
Cajón o tolva acoplado a estantería, 493
Cajón o tolva preparado para acoplar a estantería por el cliente, 493
Cajón o tolva preparado para acoplar por el cliente, 494
Cajón para pescado o marisco con drenaje, 455
Cajonera para mesa mural con cartelitas (400 mm.), 289
Cajones, 492
Calentador de agua instantáneo, 198, 233
Calentador de platos mediante aire, 316
Calentador de platos para estante de sobremesa, 315
Calzo elevador para fibra, 81
Cambiador de pañales horizontal plegable, 413
Campana extractora mural acero inoxidable, 318
Canal colector industrial para interiores en acero inoxidable, 239
Candado para pomo articulado, 351, 489
Caño 200 mm. de repuesto para grifo monomando sobremesa 463242, 277
Caño acoplable a grifo ducha, 276
Caño acoplable a mástil de grifo ducha 200mm., 276
Caño acoplable a mástil de grifo ducha 250mm., 276
Caño bajo de 200mm. para válvulas, 276
Caño bajo de repuesto para grifo monoblock 463234, 276
Caño blanco de repuesto para grifo 464633, 277
Caño ducha extraíble, 260

Bidón de 10 lts, 301
Bidón de 10 lts para lavamanos autónomo, 201
Bisagra de piano inox, 66
Bolsa de tornillería y juntas (repuesto) para grifo ducha, 275
Bolsa térmica para transporte de pizza, 157
Bolsas colgantes 350x450, 400
Bolsas de paraguas para dispensador - 200 ud., 472
Bomba de vacío para botella de vino, 172
Bombilla calentadora inastillable, 315
Bombilla LED antimosquitos, 378
Botas de agua PVC/Nitrilo, 359
Botellero, 301
Botellero de sobremesa para botellas de vino, 37
Botellero expositor inox de sobremesa para botellas de vino, 38
Botelleros, 462
Bowl de acero inoxidable, 162
Bowls en policarbonato transparente, 162
Box modular 1 cajón y puerta, 312
Box modular 1 puerta, 312
Box modular 4 cajones, 312
Box modular guías GN, 312
Boxes modulares, 312
Buzón de acero inoxidable apertura superior, 485

Caño fijo, 259
Caño fijo 1/2", 199
Caño giratorio 1/2", 199
Caño giratorio de acero inoxidable, 259
Caño giratorio extra bajo, 260
Caño giratorio extra bajo 1/2", 199
Caño mural giratorio, 260
Caño negro de repuesto para grifo 464632, 277
Caño para válvula monomando dos aguas, 276
Cañón de ozono portátil 7.000 mg/h, 368
Caperuza porta-cenicero para papelera, 490
Carnicero, 118
Carro bandejero multinorma (Gastronorm / Euronorm / Pastelería), 324
Carro bañera para elevador, 323
Carro de lavado con desagüe en acero inoxidable, 323
Carro de limpieza, 404
Carro de limpieza multifunción con bolsa, plataforma y 3 bandejas, 405
Carro de manutención con ruedas y desagüe, 322
Carro de plataforma inox con asa retráctil, 325
Carro de recogida, 320
Carro de transporte, 325
Carro Euronorm, 324
Carro para canales, 327
Carro porta barriles de cerveza en acero inoxidable, 484
Carros de servicio, 319
Carros Gastronorm, 323
Cartelas abatibles para estantes murales, 52
Cartelas imagine, 28
Cartelas para estantes murales, 17
Cartucho de repuesto para grifos 464632 y 464633, 280
Cartucho para caño o válvula 1/4 de vuelta, 280
Cartucho para válvula, 281
Cartucho para válvula monomando, 279
Cartucho para válvula RD, 280
Cartuchos para modelos descatalogados, 281
Cascanueces, 169
Cazo, 140
Cazo para salsa en acero inox, 153
Cebollero, 117
Cenicero con soporte y depósito de arena, 490
Cenicero mural NF, 491
Cenicero papelera, 490
Cenicero para espacios reducidos, 491
Cenicero para espacios reducidos de pie, 491
Centro de reciclado 4 elementos, 389
Cepillo + palo polipropileno alimentario, 405
Cepillo cerdas inox, 80

Cepillo de limpieza con mango orientable para hornos profesionales, 157
 Cepillo de mano multiusos metal detectable, 406
 Cepillo lavavasos, 234, 460
 Cepillo limpiaúñas de uso personal, 427
 Cepillo rascador de fibras, 80
 Cepillos para limpieza de manos y uñas, 427
 Cerradura, 351, 375, 489
 Cerradura con cadena para consigna de carros, 351, 489
 Cerradura de retorno de monedas, 346, 348, 349, 351, 489
 Cerradura electrónica para taquilla, 346, 348, 349, 351, 489
 Cerradura maestra, 346, 348, 351, 489
 Cesta alimentaria ligera, 456
 Cesta alimentaria plegable, 456
 Cesta de la compra supermercado apilable 60 litros con ruedas, 458
 Cesta de lavavajillas para bandejas Euronorm o Gastro-norm, 459
 Cesta de supermercado sencilla, 457
 Cesta especial platos para lavavajillas, 459
 Cesta especial vasos para lavavajillas, 459
 Cesta expositora de rejilla circular 3 niveles, 469
 Cesta expositora de rejilla rectangular, 469
 Cesta rectangular, 166
 Cesta redonda, 167
 Cesta simple para lavavajillas, 458
 Cestas alimentarias, 456
 Cestillo de plástico para cubiertos, 460
 Chaira cerámica, 133
 Chaira diamantada, 134
 Chairas, 133
 Champanera acero inox, 174
 Chuleteros, 89
 Cierra bolsas inox, 471
 Cinta antideslizante adhesiva amarillo/negro, 404
 Cinta mural extensible de señalización, 477
 Cocina, 126
 Cocina alveolado, 116
 Cocinero, 124
 Cocinero , 125
 Cocinero forjado, 115
 Coctelera, 173
 Codo a 90° M-H de 1/2", 202
 Colador, 141
 Colador/Tamizador, 141
 Columna con dispensador de gel hidroalcohólico especial para niños, 416
 Columna con dosificador de gel hidroalcohólico de funcionamiento a codo, 416
 Columna de acero inoxidable para dispensadores, 478
 Columna inox de desinfección para gel hidroalcohólico, 414
 Columna inoxidable con dispensador "Su turno", 478
 Columna mixta para guantes y botella de gel hidroalcohólico, 415
 Columna mixta para guantes y dispensador electrónico de gel hidroalcohólico, 414
 Columna para botella de gel hidroalcohólico, 415
 Columna para botella de gel hidroalcohólico especial para niños, 416
 Columna señalización con cinta, 477
 Columnas para tubo de 38 mm, 42
 Columnas perforadas para pletina, 40
 Conector rápido universal H1/2", 268
 Conjunto aros de emplatador, 85, 144
 Conjunto de 6 aros de emplatador en acero inox, 144
 Conjunto de conos para relleno de crema en acero inox, 159
 Conjunto de ducha y pulsador profesional, 272
 Conjunto de ducha, grifo monomando y mástil, 271
 Conjunto dispensador de 3 salsas con dosificadores y soporte, 149
 Conjunto dispensador de guantes y bolsas colgantes, 395
 Conjunto dispensador de guantes y bolsas en rollo, 395
 Conjunto lavamanos y fregadero mural, 194
 Conjunto lavamanos y fregadero mural XS, 194
 Conjunto peto, jabonera electrónica y dispensador tissues para lavamanos autónomo, 192
 Conjunto rompe marisco, 163
 Conjunto sal y pimienta, 169
 Conjunto sujeción inferior para válvula 462406, 276
 Conjunto sujeción inferior válvula de un agua, 275
 Conjunto sujeción inferior válvula dos aguas, 276
 Conjunto sujeción inferior válvula monomando dos aguas, 275
 Conjuntos dispensadores de guantes y bolsas con pape-
 leras, 396
 Cono recoge grasas antigoteo para jamón, 108
 Consigna mural para carros, 488
 Consigna para carros, 488
 Consigna para carros con taquilla, 488
 Consumibles para dispensadores, 400
 Contenedor de desperdicios, 386
 Contenedor de desperdicios 80L serie GO, 390
 Contenedor de desperdicios 95 lts, 311, 388
 Contenedor de desperdicios con tapa y ruedas, 385
 Contenedor de desperdicios y reciclaje, 300, 301, 389
 Contenedor de plástico con tapa 55 litros, 311, 388, 393
 Contenedor de reciclaje vertical, 391
 Contenedor Gastronorm aislamiento térmico, 177, 453
 Contenedor higiénico sanitario con apertura a pedal, 393
 Contenedor inox para vaciado de bandejas de comida
 rápida fast-food, 311, 388
 Contenedor inoxidable con tapa, 386
 Contenedor inoxidable con tapa de apertura a pedal, 386
 Contenedor inoxidable con tapa y ruedas especial pana-
 dería, 387
 Contenedor isotérmico Euronorm 82 L., 177, 453
 Contenedor isotérmico para bebidas con dispensador, 454
 Contenedor para hielo, 322
 Contenedor para reciclado, 390
 Contenedor para transporte de cuchillos, 137
 Contenedor para transporte de cuchillos con ruedas, 137
 Contenedor para transporte de hielo, 322
 Contenedor porta-bolsas con tapa y ruedas, 386
 Contenedor porta-bolsas sistema "tijera", apertura a pedal, 387
 Copa en policarbonato, 167
 Copa helado, 434
 Corta mariscos forjado, 169
 Cortador de pizza, 156
 Cortador de pizza profesional, 156
 Cortadora de fiambres manual, 148
 Cortadora de masa de pizza, 154
 Cortar pan, 123
 Cortina de lamas de PVC, 484
 Cortina de ozono especial pescaderías, 369
 Cronómetro de cocina, 364
 Cruces para tubo, 60
 Cubertero, 461
 Cubertero plástico gris GN 1/1, 461
 Cubetas Gastronorm alta temperatura, 440
 Cubetas Gastronorm copoliéster, 438
 Cubetas Gastronorm lisas, 435
 Cubetas Gastronorm lisas., 81
 Cubetas Gastronorm perforadas, 436
 Cubetas GN para identificación de alérgenos, 441
 Cubetas para helado, 432
 Cubierta basculante para cubetas Gastronorm 1/1, 467
 Cubierta protectora para mostrador de pescadería, 330
 Cubitera con tapa de acero inox, 174
 Cubo de acero inoxidable con tapa 15L serie GO, 408
 Cubo industrial asa de acero inoxidable, 407
 Cubo pedal baño con papelera interior, 394
 Cubo plástico con asa metálica para fregar, 407
 Cubos premium de acero inox, 408
 Cobre aperitivos BC, 466
 Cuchara de mesa, 168
 Cucharón de servir, 140
 Cuchilla de golpe, 91
 Cuchillas de repuesto para afilador 448304 Juego de 4
 cuchillas, 2 gomas protectoras grandes (63x48 mm.) y 1
 goma protectora pequeña (45x20 mm.), 134

Cuchillería forjada, 115
Cuchillo antioxidante para verduras, 122
Cuchillo cocinero con filo dentado, 121
Cuchillo cortador de tajadas de sandía o melón, 130
Cuchillo de mesa corte liso, 168
Cuchillo de mesa modelo chuletero, 168
Cuchillo de mesa modelo chuletón, 168
Cuchillo especial alimentos congelados, 123
Cuchillo especial queso Emmental, 98
Cuchillo especial queso Feta, 98
Cuchillo especial queso lama perforada, 97
Cuchillo especial queso Parmesano, 98
Cuchillo especial queso Pavia, 97

D

Decorador, 129
Decorador de fruta, 129
Defensa de esquina tubular 90°, 58
Deglon Meeting 3 piezas, 119
Delantal de escay, 355
Delantal de protección en malla de acero inoxidable, 355
Desagüe de poliamida blanca 3/4" L=90 mm., 332
Desagüe flexible para lavamanos autónomo 1 1/2", 200
Descorazonador, 129
Deshuesador, 124
Deshuesar, 118
Deshuesar Carne, 91
Deshuesar forjado, 116
Deshuesar jamón, 111
Deshuesar jamón curvo, 111
Deshuesar jamón forjado, 110
Desollar, 92
Despellejar, 118
Detalles, 41
Detector de anisakis, 114
Discos de respuesto para máquina de hacer churros y pastas, 160
Dispensador de bobina industrial, 426
Dispensador de bolsas, 395
Dispensador de bolsas colgantes, 397
Dispensador de bolsas en rollo, 397
Dispensador de bolsas para envasado de alimentos, 398
Dispensador de bolsitas higiénicas, 425
Dispensador de gel hidroalcohólico automático de columna, 414
Dispensador de gel hidroalcohólico automático en acero inox, 418
Dispensador de gel hidroalcohólico de gran capacidad a pedal, 418
Dispensador de guantes, 397
Dispensador de mascarillas FFP2, 400
Dispensador de papel higiénico modelo Nube, 425
Dispensador de papel higiénico tripe en acero inoxidable, 423
Dispensador de papel mecha, 426

E

Elevador inox de fondo de fregaderos, 231
Elevador inox para cesta de supermercado, 458
Embellecedor para tocho, 65
Embudo, 149
Emplazamiento publicitario opcional para columna, 417
Enchufe con mando a distancia, 374, 384
Enfriador de agua, 212, 233
Enjuagador de vasos y jarras a presión para fregadero, 234, 460
Enrollador de maki higiénico, 86
Enrollador de maki super-higiénico, 145
Entrepaño para carro de servicio de 1.000x500 mm., 321
Entrepaño para carro de servicio de 1.200x500 mm., 321
Entrepaño para carro de servicio de 800x500 mm., 321
Envasadora al vacío, 470
Envase take away / delivery rectangular con tapa, 178
Envase take away / delivery redondo con tapa, 178
Envolvedora de sobremesa, 471

Cuchillo especial queso tierno, 97
Cuchillo francés inyectado Adherent+, 91, 120
Cuchillo panero de hoja ancha, 123
Cuchillo panero de mango elevado y filo ondulado, 123
Cuchillo panero especial pizza, 123
Cuchillo pelador, 122
Cuchillo todos usos, 90, 121
Cuelga copas, 463
Cuelga copas y tazas en varilla, 463
Cuencos, 162
Cuencos para salsas, 162
Cutter combi (Metal detectable), 484

Dispensador de papel mecha acoplado a columna, 417
Dispensador de papel mecha en acero inox, 426
Dispensador de papel mini-mecha modelo Nube, 425
Dispensador de rollos de papel higiénico, 423
Dispensador de rollos de papel higiénico inoxidable, 423
Dispensador de salsa con dosificador, 149
Dispensador de tickets su turno, 477
Dispensador de tissues, guantes, toallas, etc., 400
Dispensador de toallas, 424
Dispensador de toallas de papel con autocorte, 424
Dispensador de toallas modelo Nube, 425
Dispensador de vasos, 316, 463
Dispensador de vasos universal, 464
Dispensador en acero inoxidable de toallas de papel, 424
Dispensador inox hexagonal de papel higiénico 400 m, 424
Dispensador inox para cepillos de limpieza de manos y uñas, 427
Dispensador mural de bobina industrial, 426
Dispensador mural de papel alimentario, 398
Dispositivo para abrir puertas anti-contagio, 429
Doble fondo para cubeta gastronorm, 437
Dosificador automático de gel hidroalcohólico con soporte de sobremesa, 420
Dosificador de gel-espuma, 420
Dosificador de jabón, 419
Dosificador de jabón encastrable 600 ml., 202
Dosificador de jabón inox, 420
Dosificador de jabón inox encastrable, 421
Dosificador de jabón modelo Nube, 419
Dosificador de salsas - 30 ml., 151
Dosificador de salsas y recipiente inox, 150
Ducha de gran alcance H de 1/2", 263
Ducha higiénica con llave de paso, 272
Ducha higiénica serie basic, 273
Ducha horno enrollable bajo encimera, 264
Ducha horno enrollable H de 1/2", 264
Ducha horno H de 1/2", 263
Ducha mural de emergencia, 403
Ducha para horno pulsador, 264

Equilibrador, 268, 478
Escalones inox, 479
Escalones para vitrinas, 464
Escamador, 112
Escamador EC, 113
Escanciador de vino, 172
Escoba haragán para empujar agua, con mango ergonómico, 405
Escurreidor de ollas regulable, 142
Escurreidor de platos y vasos en acero inoxidable, 146, 220
Escurreidor de verduras, 142
Escurreidor inox para cubetas Gastronorm, 445
Escurreidor mural para utensilios de cocina, 145, 220
Escurreidor para fibras de corte, 80
Espátula de silicona y acero inox, 159
Espátula para planchas de cromo-duro, 152
Espátula para preparación pizza en acero inox, 156
Espátula pastelera, 159
Espátula plástica, metal detectable, 405



Espátulas, 140
Especiero inox con tres niveles, 145
Espejo antivandálico acero inoxidable, 412
Espejo Inox, 195
Espigas macho para sacacorchos de pared 483416, 171
Espumadera, 140
Espumadera inoxidable con mango de plástico, 140
Espumador eléctrico manual mini con soporte, 141
Esquinar, 90
Estación de higiene para wc con dispensador de papel y escobillero en acero inoxidable, 410
Estante abatible de fibra para punto de venta portátil de jamones, 108, 305
Estante especiero, 145
Estante inox para almacenaje de vino, 36
Estante mural de fibra abatible, 18
Estante mural especial microondas, 14
Estante mural inclinado para cestas de lavavajillas, 18
Estante mural porta-barquetas, 18
Estantería con armario para botellas de zumo, 35
Estantería gastronorm imagine, 24
Estantería inox para almacenaje de vino, 36
Estanterías de sobremesa, 21, 300, 313
Estanterías gastronorm imagine a pared, 26
Estanterías modulares con estantes lisos, 9
Estanterías suspendidas, 20, 314
Estantes de suelo, 17
Estantes fibra imagine, 29
Estantes inox imagine, 29
Estantes lisos para estanterías modulares, 10
Estantes murales, 16

F

Felpudo higiénico de caucho, 429
Fiambre, 96
Fiambre dos mangos, 96
Fiambra de cristal con tapa hermética, 446
Fibra de colores intercambiables, 82
Fibra para corte de pan, 83
Fibra redonda de corte de polietileno de alta densidad P500, 77
Fibras a medida, 77
Fibras chuleton rectangulares, 163
Fibras estándar, 75
Fibras estándar 400x300x20, 81
Fibras GN, 76
Fibras por planchas, 79
Fileteador flexible, 118
Filetear, 117
Fileteros, 89
Filtro agua fría para Futura, Cold+ y Enfriador de agua, 214
Filtro Bestmax para Futura fría y caliente, 214
Filtro inoxidable para campana extractora industrial, 318
Filtro profesional de agua Brita, 214
Filtro repuesto HEPA 13, 366
Fluxómetro para WC, 273
Fondos perforados para cubetas Gastronorm copoliéster, 439
Fondos perforados para recipientes de polipropileno, 442
Forro isoterma interior para cajas de reparto / distribución, 176, 454
Fregadero especial para escayolas, 232

G

Gafas antiproyecciones, 359
Gancho de arrastre, 49
Gancho de varilla modelo " J ", 45
Gancho de varilla multifunción, 47
Gancho giratorio, 48
Gancho pesador, 62
Ganchos de varilla modelo " J ", 45
Ganchos de varilla modelo " S ", 46
Ganchos de varilla modelo " S ", 46
Ganchos forjados, 44
Ganchos jamoneros, 47

Estantes murales cartelas modelo compacto, 14
Estantes murales con cartelas, 16
Estantes murales de tubo, 14
Estantes murales regulables imagine, 15
Estárter para 15 W, 383
Estárter para 30 W, 383
Esterilizador de cuchillos mediante agua caliente para adosar, 370
Esterilizador de cuchillos mediante ozono para adosar, 370
Estropajo para tablas de corte, 81
Europalet higiénico reforzado, 482
Expositor central de grifería, 246
Expositor de frutas y verduras inox con ruedas, 337
Expositor mural de grifería, 246
Expositor mural de grifería con grifos, 246
Extensión cesta simple, 458
Exterminador de insectos interior/exterior mediante parrilla eléctrica Serie LD120, 378
Exterminador de insectos mediante parrilla eléctrica serie UK-INOX, 376
Exterminador de insectos mediante trampa adhesiva serie BC, 379
Exterminador de insectos mediante trampa adhesiva serie MR LED, 377
Exterminador de insectos mediante trampa adhesiva serie UL, 376
Exterminador de insectos mediante trampa adhesiva Serie V30, 378
Exterminador de insectos serie SP-80 LED, 377
Extra-short table shower fitting support, 274

Fregadero para bicicletas XL, 232
Fregadero vertedero, 231
Fregaderos, 218, 219
Fregaderos colgantes con cartelas, 224
Fregaderos colgantes con faldón o palomilla de doble seno, 227
Fregaderos colgantes con faldón o palomillas, 226
Fregaderos con puertas de corredera y abatibles, 228, 229
Fregaderos con soporte, 222, 223
Fregaderos para encastrar, 217
Fregaderos para lavavasos y lavaplatos, 221
Fregaderos para soldar, 217
Fregaderos portátiles, 230
Fregaderos soldados a mesas, 317
Fregona profesional con tiras de microfibra y casquillo Pro, 407
Frontal curvado transparente de 963 mm., 332
Fuente de agua fría Cold+, 206
Fuente de agua fría Cold+ mural, 206
Fuente de agua fría de columna, 207
Fuente de agua fría de columna con grifo electrónico sin contacto, 207
Fuentes de agua fría, caliente y del tiempo Futura, 205
Fuentes de columna sin refrigeración, 210
Fuentes murales refrigeradas de agua fría Cold+ a pedal, 208
Fuentes murales sin refrigeración, 211
Fuentes refrigeradas de agua fría Cold+ a pedal, 209
Funda antivibradora para taco regulable, 499
Funda reutilizable para carro de pastelería Euronorm, 325

Ganchos salchicheros, 48
Garras galvanizadas para tirantes, 56
Gaveta expositora, 468
Generadores de ozono inyectado para interior de cámaras frigoríficas, 367
Goma de repuesto para contenedor porta-bolsas, 393
Goma elástica para la sujeción de bolsas de basura en lavamanos, 201
Grifería, 241
Grifo Clinic Expert, 258
Grifo cocina monomando sobremesa cuello de cisne de

acero inoxidable, 247
Grifo cocina monomando sobremesa de acero inoxidable, 247
Grifo cocina sobremesa doble función de acero inoxidable, 252
Grifo columna sobremesa 2 aguas pomo aislante, 256
Grifo de cocina efecto granito, 250
Grifo de cocina inteligente contactless con selector de temperatura, 258
Grifo de columna orientable sobremesa 2 aguas monomando, 257
Grifo de columna orientable sobremesa de un agua, 256
Grifo de columna orientable sobremesa pomo aislante, 255
Grifo de palanca un agua M-M de 1/2", 198
Grifo de sobremesa dos aguas con pomo aislante, 255
Grifo de sobremesa electrónico, 259
Grifo ducha monomando sobremesa dos aguas serie doméstico, 248
Grifo ducha sobremesa serie doméstico con piña, 247
Grifo electrónico inoxidable a pilas para fuente de agua 1/2", 214, 262
Grifo electrónico temporizado para urinario. Funcionamiento a pilas, 273
Grifo giratorio extrabajo dos aguas, 252
Grifo giratorio extrabajo un agua, 252
Grifo giratorio sobremesa 1/4 vuelta un agua caño bajo, 253
Grifo giratorio sobremesa dos aguas 1/4 de vuelta caño bajo, 252
Grifo giratorio sobremesa dos aguas serie 1/4 de vuelta, 251
Grifo giratorio sobremesa dos aguas serie extra bajo, 253
Grifo llenajarras, 263
Grifo llena-jarras, 214
Grifo llenajarras de acero inoxidable, 263
Grifo llenajarras electrónico acero inoxidable para fuente de agua, 214, 263
Grifo manguera 50 m. con soporte inox y pistola, 265
Grifo manguera enrollable inoxidable serie compacto, 266
Grifo manguera enrollable serie básico, 267
Grifo manguera enrollable serie inoxidable, 267
Grifo manguera enrollable serie profesional, 265
Grifo manguera enrollable serie profesional plus, 266
Grifo mezclador sobremesa con mandos 1/4 de vuelta, 251
Grifo monoblock electrónico con selector de temperatura. Funcionamiento a pilas, 258
Grifo monomando mural de codo dos aguas serie monoblock-bajo, 254
Grifo monomando mural de codo dos aguas serie monoblock-elevado, 254
Grifo monomando mural de codo para dos aguas, 254
Grifo monomando para baño/ducha serie Ecológica, 271
Grifo monomando para bidé serie Ecológica, 270
Grifo monomando para ducha serie Ecológica, 271
Grifo monomando para lavabo serie Ecológica, 269
Grifo monomando sobremesa caño alto para fregadero, 248

H

Hacer agujero de desbarasado a estantes imagine, 29
Hacer agujero en fregadero o lavamanos, 201, 235
Hacha de bombero con mango de fibra, 430
Hacha de cámara con mango de fibra, 430

I

Indicador de suelo mojado, 404
Interruptor luminoso On/Off, 375

J

Jabonera, 411
Jabonera electrónica (funcionamiento a pilas), 420
Jamón serrano, 109
Jamón serrano alveolado punta redonda, 110
Jamón serrano punta redonda, 110
Jamón serrano virola, 109
Jamonero antiadherente, 125
Jamonero giratorio basculante RT-3D, 102
Jamonero giratorio mural RT-2D, 102

Grifo monomando sobremesa caño giratorio elevado, 249
Grifo monomando sobremesa con caño bajo, 253
Grifo monomando sobremesa de codo dos aguas, 249
Grifo monomando sobremesa de codo dos aguas serie monoblock, 249
Grifo monomando sobremesa de codo dos aguas serie monoblock-elevado, 250
Grifo monomando sobremesa de codo elevado, 251
Grifo monomando sobremesa de columna, 256
Grifo monomando sobremesa dos aguas caño frontal, 250
Grifo monomando sobremesa extensible de codo, 248
Grifo monomando sobremesa extensible de codo leva larga, 248
Grifo monomando sobremesa giratorio dos aguas, 249
Grifo monomando sobremesa para fregadero serie Ecológica, 250
Grifo mural de 1 agua con pomo aislante caño alto, 255
Grifo mural de 1 agua con pomo aislante caño bajo, 255
Grifo mural de codo un agua, 254
Grifo mural dos aguas 1/4 de vuelta caño bajo, 253
Grifo mural dos aguas cuarto de vuelta, 253
Grifo mural electrónico. Funcionamiento a pilas, 259
Grifo para fuente de agua sin pulsador, 214, 262
Grifo para lavabo de 1 agua, 269
Grifo pulsador para fuente, 214, 262
Grifo sobremesa de un agua serie 1/4 de vuelta, 247
Grifo sobremesa electrónico, 199
Grifo sobremesa electrónico de acero inoxidable, 259
Grifo temporizado dos aguas, 270
Grifo temporizado para urinario, 273
Grifo temporizado un agua, 270
Grifos ducha de sobremesa, 242
Grifos ducha de sobremesa extra bajos, 244
Grifos ducha de sobremesa monomando, 243
Grifos ducha murales, 245
Grifos giratorios sobremesa dos aguas, 251
Guante de cinco dedos ambidiestro en malla de acero inoxidable, 354
Guantes alimentarios anticorte, 355
Guantes anticalóricos hasta 100°C, 356
Guantes anticorte industrial, 357
Guantes anti-salpicaduras aceite hirviendo, 356
Guantes de nitrilo escamados talla L (caja 50 ud.), 358
Guantes de nitrilo para uso alimentario, 358
Guantes de piel industrial, 358
Guantes de protección química, 358
Guantes para frío extremo en piel, 357
Guantes para frío extremo en PVC hasta -20°C, 357
Guantes para pescadero, 356
Guardavivos exterior de acero inoxidable, 487
Guardavivos interior de acero inoxidable, 487
Gubia deshuesar jamón, 110

Hoja de repuesto inox., 93
Hojas de repuesto en acero inoxidable para espátula plancha de cromoduro., 152

Isla de cocina inox con encimera de granito, 303
Isla de cocina inox con encimera de madera de pino, 303

Jamonero giratorio RT-2D, 102
Jamonero para adosar a tajo con madera, 74, 104
Jamonero titanio, 124
Jamonero Zwilling, 117
Jarra de agua, 167
Jarra medidora con fondo antideslizante 1 L, 160
Jarra medidora de cristal 1 L., 160
Juego de 4 esponjas de colores, 406
Juego de café de 5 piezas para 6 tazas, 175



Juego de cuchillas de repuesto paracepillo rascador., 80
Juego de cuchillas de repuesto., 484
Juego de dos tapones de repuesto para bomba vacío, 172
Juego de herrajes para puertas (para 2 puertas), 489
Juego de juntas para el mástil del grifo ducha, 275
Juego de juntas para grifo manguera serie profesional 8 m., 282

K

Kit de conexión a red de agua para lavamanos autónomo, 192
Kit de acoplamiento a rueda, 497
Kit de acoplamiento de rueda a bastidor de carros de servicio, 321
Kit de fijación para estanterías de sobremesa, 21, 313
Kit de juntas para pulsador no temporizado 460404, 198
Kit de juntas para pulsador temporizado, 278
Kit de pletinas para estanterías, 11

L

Laminador de tartas, 158
Lámpara de 15 W., 375
Lámpara de 30 W., 375
Lámpara para calentar platos, 315
Lámpara UV-C 2 pines 10 W., 366
Lanza rociadora M 1/2", 282
Largueros inferiores imagine, 27
Largueros superiores imagine, 28
Lateral transparente, 332
Latiguillo de repuesto para grifo 463052, 274
Latiguillo de repuesto para grifo 463220, 274
Latiguillo de repuesto para grifo doméstico 463050, 278
Latiguillo inferior para grifo ducha dos aguas, 276
Latiguillo inox. plastificado para grifo ducha, 274
Latiguillo lastrado para grifo monomando ducha extensible, 278
Latiguillo para ducha horno 2000 mm H-H 1/2", 282
Latiguillo para ducha horno enrollable 463006 y 463008, 282
Latiguillos flexibles en malla de acero inoxidable H-H de 1/2", 200, 274
Latiguillo para ducha de gran alcance 2000 mm H-H 1/2", 282
Lavabotas manual en acero inoxidable, 403
Lavamanos autónomos, 190

M

Mampara de protección de sobremesa, 428
Mampara de protección para colgar, 428
Mando inalámbrico de repuesto, 477
Mandolina para cortar / laminar trufas en acero inoxidable, 148
Mango de repuesto para serrucho, 93
Manguera de repuesto 12 m. para grifo manguera serie profesional, 282
Manguera de repuesto 15 m. para grifo manguera serie inox., 282
Manguera de repuesto 8 m para grifo de manguera serie profesional, 282
Manguera flexible de 1", 332
Manoplas anticálóricas hasta 250°C, 356
Manoplas anticálóricas hasta 500°C, 357
Máquina para hacer churros y pastas, 160
Máquina termoselladora para bolsas de 400 mm., 472
Marquesina para puertas, 485
Mástil con caño para grifo ducha, 275
Mástil extra corto para grifo ducha, 274
Mástil para grifo ducha, 274
Mazo de picar, 84
Mazo para chino, 85, 142
Medidor de compuestos polares / calidad del aceite de fritura, 364
Medidor de PH, 365
Mesa / Carro auxiliar multifuncional para instrumental o de servicio con ruedas, 320
Mesa barman, 301
Mesa central con dos entrepaños. Especial cortadoras de fiambre, 296
Mesa central con dos entrepaños. Especial cortadoras de

Juego de llaveros numerados del 1 al 6, 351, 489
Juego de muelle y juntas para piña de grifo ducha, 274
Juego de placas numeradas del 1 al 6, 351, 489
Juego válvulas antirretorno para grifo monomando dos aguas, 278

Kit de útiles para barbacoa, 131
Kit golpeador para cajón modular, 313
Kit golpeador para cajón pequeño, 495
Kit para colgar utensilios, 49, 106, 300
Kit para colgar utensilios imagine, 30
Kit portarrollos insonorizado para papel o film, 399
Kits de portarrollos de papel o film, 399
Kits de portarrollos de papel o film serie Eco, 106, 399

Lavamanos electrónico 3D, 193
Lavamanos mural colectivo, 195
Lavamanos mural colectivo de rodilla agua fría y caliente, 195
Lavamanos murales, 184
Lavamanos murales electrónicos, 187
Lavamanos quirúrgico con grifos mixtos, 197
Lavamanos quirúrgico doble con grifos electrónicos, 197
Lavamanos quirúrgico mural con grifería, 196
Lavamanos registrables de agua fría y caliente, 182
Lavamanos registrables electrónicos, 186
Lavaojos mural de emergencia en acero inoxidable, 403
Lavaporcionador de helados mural, 433
Lavaporcionador de helados para encastrar, 433
Lenguado, 121
Leva de repuesto para grifo monomando sobremesa 463242, 276
Librador , 142
Limpiador de acero inoxidable, 500
Lira para cortar queso, 98
Llave maestra para cerraduras, 346, 348, 349, 351, 489
Losetas antideslizantes, 480
Lower fixing set for single inlet valve, 275

fiambre con reborde de seguridad, 297
Mesa central con entrepaño especial maquinaria - Altura estándar, 298
Mesa central con entrepaño. Especial maquinaria, 298
Mesa central con estantes de sobremesa sistema imagine, 34
Mesa central con ruedas y 2 entrepaños, 297
Mesa central de emplatado imagine, 32
Mesa central inox con encimera de cristal translúcido, 303
Mesa de preparación de verduras, 291
Mesa de terraza, 300
Mesa jamonera RT-2D, 105, 305
Mesa jamonera RT-3D, 106, 305
Mesa mural con cartelas, 289
Mesa mural con estantes sobremesa serie imagine, 33
Mesa mural con puertas y sistema de elevación eléctrico, 299
Mesa mural de prelavado, 293
Mesa mural desbarasado con fregadero, 290
Mesa mural desbarasado con puerta, 291
Mesa mural desbarasado y reciclaje con puerta, 389
Mesa mural inox con sistema de elevación, 299
Mesa mural sotabanco con dos entrepaños, 296
Mesa para cocción de marisco, 335
Mesa para maquinaria con sistema de elevación, 298
Mesa para marisco, 335
Mesa-bastidor para horno, 295
Mesas centrales, 287
Mesas centrales con reborde y desagüe, 309
Mesas centrales encimera de polietileno, 306
Mesas de despiece, 310
Mesas de entrada / salida de lavavajillas, 294

Mesas de preparación centrales, 307
Mesas de preparación murales, 308
Mesas de preparación y lavado, 292, 333
Mesas murales, 287
Mesas murales a pared, 288
Mesas murales con puertas, 288
Mesas murales con puertas y cajones, 289
Mesas murales con reborde y desagüe, 309
Mesas murales de cajones, 295
Mesas murales de Chef, 290
Mesas plegables con entrepaño, 296
Mezclador antiretorno M-H-M 1/2", 202
Modelo cocina, 120
Molde para laminar tartas 24/30 cms., 158
Moldes cuadrados, 144
Molinillo 2 en 1 sal y pimienta, 146
Molinillo de hierbas, 146
Molinillo juliana, 147
Monitor de calidad del aire detector de CO₂, 366

O

Opción de kit de ozono acoplado., 344, 345, 346, 348, 349
Oxigenador de vino, 172

P

Pack de 6 colores de repuesto, 82
Pala cuadrada de aluminio para horno, 155
Pala de acero inoxidable y polietileno, 84
Pala de mano para hielo, 336, 466
Pala inox para loncheado de embutidos, 99
Pala inox para servir tarta, 159
Pala inoxidable para patatas fritas con dos asas, 150
Pala para hielo, 336, 465
Pala para hielo en acero inox, 173
Pala para pizza, 155
Pala para tartas / pizza en acero inox, 160
Pala redonda de aluminio para horno, 155
Palanca para válvula monomando dos aguas, 276
Palanca repuesto para válvulas 462412, 462408, 463206, 276
Palanca un agua M-M 1/2", 261
Palet encajable de plástico liso, 481
Palet encajable enrejado, 481
Palet para embutidos, 327
Palet para jamones, 326
Paleta, 140
Paleta de fibra para aplastar hielo, 336
Paleta oval en acero inox, 155
Paleta oval en acero inox perforada, 155
Paleta para servir pizza en acero inox, 156
Paleta redonda aluminio, 156
Paletas y espátulas, 127
Panel medidor de CO₂ monitor de calidad del aire mural / sobremesa, 365
Panero cerámico, 126
Panero con revestimiento antiadherente, 125
Panero de titanio, 124
Panero forjado, 116
Pantalla antiproyecciones, 359
Papeleras, 200, 394
Papeleras acopladas, 417
Papeleras basculante en acero inoxidable, 392
Papeleras con tapa y pedal, 394
Papeleras con tapa y ruedas 70 lt, 387
Papeleras de plástico con pedal, 393
Papeleras de reciclaje, 390
Papeleras inox de 70 lt apertura frontal, 392
Papeleras modelo Design, 394
Papeleras modelo Design (lavamanos integral mural), 200
Papeleras su turno para mostrador, 341
Papeleras su turno para mostrador de pescadería, 331
Papeleras-dispensador de bolsas de papel, 398
Papeleras-dispensador de papel, 200
Parachoques para carros de servicio, 321
Paragüero inox, 472

Monomando baño/ducha, 271
Monomando bidé, 269
Monomando ducha, 270
Monomando lavabo, 269
Montaje cerradura electrónica en puerta de taquilla (no incluye cerradura), 351, 489
Montaje de la cerradura de retorno de monedas (no incluye cerradura), 351, 489
Mortero, 85
Mortero de acero inox, 141
Mostrador de pescadería, 329
Mostrador de pescadería con soporte, 328, 330
Mostrador frutería, 338, 340
Mostrador frutería sobre obra, 339
Mueble cafetero inox basic, 302
Mueble cafetero inox doble, 302
Muelle elevación de palanca, 95
Muelle para grifo ducha, 274

Ozonizador de agua, 368

Pareja de muelles, 95
Parking para carros de la compra, 59
Parking para mascotas en acero inoxidable, 471
Parking soporte para aparcamiento de bicicletas en acero inoxidable, 472
Pasacable azul Ø 36x2,5 mm., 332
Pasacable inox, 499
Pasapuré profesional, 147
Pedal de un agua M-M de 1/2", 198
Pedal de un agua M-M de 1/2", 261
Pedal mezclador de agua fría y caliente con palanca de bloqueo H-H-H- 1/2", 260
Pedal mezclador de agua fría y caliente M-M-M de 1/2", 198
Pedal mezclador de agua fría y caliente M-M-M de 1/2", 261
Pedal opcional, 392
Pedal opcional 120 lts, 385
Pedal opcional 240 lts, 385
Pedal opcional 60 lts, 385
Pelador, 128
Pelador de cerámica, 126, 143
Pelador de espárragos, 128
Pelador forjado, 116
Pelar patas, 92
Percha industrial de acero inoxidable, 350, 473
Perchero, 473
Perchero individual, 412
Perchero mural de acero inoxidable, 473
Perfil paragolpes ángulo exterior de fibra blanca, 486
Perfil paragolpes ángulo interior de fibra blanca, 486
Perfil paragolpes curvo mural de plástico, 487
Perfil paragolpes recto de fibra blanca, 486
Perfiles divisorios para cubetas Gastronorm, 444
Pescadero, 112
Peto lateral reversible para mesas, 317
Peto postizo con taladros, 199
Peto postizo de esquina, 199
Peto postizo envolvente anti salpicaduras, 199
Peto postizo lateral reversible anti salpicaduras, 199
Peto postizo para acoplar, 199
Peto transparente imagine, 31
Picador de masa de pizza en acero inox, 153
Picador de tomate, 147
Pictograma Ascencor, 474
Pictograma Aseo Discapacitados, 474
Pictograma Aseo familiar, 474
Pictograma Aseo Hombre, 474
Pictograma Aseo Mujer, 474
Pictograma Aseo unisex, 474
Pictograma Botiquín, 474

Pictograma Cafetería, 475
 Pictograma Cambia-Bebes, 474
 Pictograma Carros, 475
 Pictograma Desinfección de calzado, 476
 Pictograma Dirección, 475
 Pictograma Distancia de seguridad, 476
 Pictograma Duchas, 474
 Pictograma Espere tras la línea, 476
 Pictograma Guantes, 476
 Pictograma Información, 475
 Pictograma Mascarilla, 475
 Pictograma Número 0, 476
 Pictograma Número 1, 476
 Pictograma Número 2, 476
 Pictograma Número 3, 476
 Pictograma Número 4, 476
 Pictograma Número 5, 476
 Pictograma Número 6, 476
 Pictograma Número 7, 476
 Pictograma Número 8, 476
 Pictograma Número 9, 476
 Pictograma Parking, 475
 Pictograma Permitido fumar, 475
 Pictograma Prohibido, 475
 Pictograma Prohibido animales, 475
 Pictograma Prohibido el paso, 475
 Pictograma Prohibido el uso de teléfono, 475
 Pictograma Prohibido fumar, 475
 Pictograma Puesto de gel hidroalcohólico, 476
 Pictograma Restaurante, 475
 Pictograma Tercera edad, 474
 Pictograma Termómetro, 476
 Pictograma Uso obligatorio de mascarilla, 475
 Pictograma Vestuario/Guardarropa, 474
 Pictograma WC, 475
 Pictograma Zona Wifi, 475
 Pictogramas en acero inoxidable, 474
 Pie de champanera, 174
 Pie inox para lavamanos mural colectivo, 196
 Pie regulable inox de Ø 63,5x150 mm., 332
 Piedra de afilar de mano, 134
 Piedra para afilar cuchillos al agua 240/320, 134
 Pies centrales imagine, 27
 Pies murales imagine, 27
 Pincel de silicona y acero inox, 158
 Pincho antipalomas en acero inoxidable, 485
 Pinchos brocheta, 161
 Pinza de servir, 139
 Pinza para bandeja de horno en acero inox, 153
 Pinza para barbacoa, 139
 Pinza para cubitos de hielo, 173
 Pinza para frituras, 139
 Pinza para servir espaguetis acero inox, 139
 Pinzas para embutidos, 111
 Piña de acero inoxidable para grifo ducha, 268, 274
 Piña de repuesto para grifo de accionamiento extensible, 268, 274
 Piña para ducha de gran alcance M 1/2", 282
 Piña para ducha horno 463006, 282
 Piña para ducha horno M 1/2", 282
 Piña para grifo ducha, 268, 274
 Piña para grifo ducha serie Ecológica, 268, 274
 Piña para grifo monomando ducha extensible, 278
 Pistola con lanza rociadora H 1/2", 268
 Pistola para lanza de acero inoxidable H 1/2", 282
 Pistola rociadora de pulverización regulable H 1/2", 268
 Pizarra de led con atril, 468
 Placa eutéctica GN 1/1 acumulador de frío de 0 a -21°C, 177, 453
 Plafón para calentar platos, 315
 Plafones para exposición de embutidos, 52, 108
 Plaqueta, 59
 Plaqueta redonda, 59
 Plataforma con freno para transporte de cestos de lavavajillas, 482
 Plataforma rodante, 482
 Plato cuatro salsas, 164
 Plato de cocktail, 164
 Plato de presentación, 163
 Plato de presentación especial pulpo, 163
 Plato ducha inox, 411
 Plato giratorio, 166
 Plato giratorio de cristal, 165
 Plato pizza, 163
 Pletinas, 43
 Pollero, 92
 Pomo articulado, 351, 489
 Pomo azul para válvula 462414 y 462416, 278
 Pomo corto para válvula 462406, 277
 Pomo de repuesto para mástil con caño, 275
 Pomo rojo para válvula 462414 y 462416, 278
 Porcionador automático de helado, 434
 Porcionadores de helado, 433
 Porta brochetas, 161
 Portacuchillos con doble alojamiento de sobremesa, 137
 Portacuchillos mural imantado, 138
 Portacuchillos mural imantado de acero inoxidable, 138
 Portacuchillos para adosar con envolvente, 74, 136
 Portacuchillos para adosar con envolvente., 70
 Portacuchillos portátil, 136
 Portacuhillos inox portátil, 374
 Portacuhillos para adosar en chapa, 74, 138
 Portacuhillos para adosar en varilla, 74, 138
 Portajamones, 103
 Portalacones, 105
 Porta-notas mural, 300, 313, 462
 Portaprecios en varilla inox, 470
 Portaprecios en varilla inox con pincho, 469
 Porta-precios imagine, 31
 Portarollos papel higiénico con repisa, 412
 Portarollos dispensador de film para envolver, 399
 Portarollos papel higiénico, 411
 Prensa ajos, 146
 Prolongación modular, 340
 Prolongación modular para mostrador de pescadería, 329, 330
 Protector auditivo, 359
 Protector para picadora de carne, 95
 Puerta, 495
 Puerta rodante para contenedores, 316
 Puesto de lavado y desinfección, 266, 413
 Puesto pescadero encimera polietileno, 334
 Puesto pescadero modelo sencillo, 334
 Pulsador inoxidable temporizado M-M de 1/2", 198
 Pulsador no temporizado M-M de 1/2", 198
 Pulsador no temporizado M-M de 1/2", 261
 Pulsador temporizado M-M de 1/2", 261
 Puntilla con mango de madera, 93
 Puntillas, 122
 Puntilla, 126
 Puntilla Zwilling, 117
 Puntilla con revestimiento antiadherente, 125
 Punto de venta portátil de jamones, 107, 304
 Punzonador de embutidos, 148
 Purificador de aire con filtro HEPA y lámpara UV hasta 60 m2, 366

Q

Queseras base plástico, 468

R

Rallador, 128

Queso, 97

Rallador de queso, 146

Rallador inox, 147
 Rampa loseta, 481
 Rasqueta cortadora de masa en acero inoxidable, 154
 Rasqueta para vitrocerámicas, 152
 Rebosadero (fregaderos serie 600 y 700 mm), 234
 Rebosadero para lavamanos 061402, 061404 y 061448, 200
 Recipientes de polipropileno, 442
 Recoge verduras, 131
 Recogedor con palo metálico, 407
 Recogedor de mano inox, 406
 Recogedor inox, 406
 Recubrimiento modular para islas de congelación, 466
 Reductor desagüe de 2" a 1 1/2", 235
 Refuerzos soldados a estantes, 11
 Registrador de temperatura y humedad, 363
 Reglajes y resistencia imagine, 23
 Rejilla de aluminio para hornear pizza, 154
 Rejillas Gastronorm de acero inoxidable, 444
 Relación de repuestos para exterminadores de insectos, 382
 Remaches tubulares, 66
 Remo, 84
 Repisa, 412
 Repuesto cuchilla para abrelatas industrial 440021, 144
 Repuesto de cepillo de limpieza. Replacement cleaning brush., 157
 Repuesto de fibras para mesas, 78
 Repuesto de mazas, 73
 Repuesto de mazas para acoplar fibra superpuesta, 73
 Repuesto de muela (grano 60) para afilador 448306, 135
 Repuesto de muela abrasiva (grano 120) para afilador 448306, 135
 Repuesto de tirante a pared y soporte para piña para grifos 463080 y 463081, 275
 Repuesto fibra para 041062, 137
 Repuesto fibra para 041060, 137
 Repuesto golpeador de posos de café, 495

S

Sacacorcho navaja, 170
 Sacacorcho Tirolés, 170
 Sacacorchos mural, 171
 Salmón Victorinox, 118
 Salmón de titanio, 124
 Salsera 8 salsas, 165
 Salsera circular 6 salsas, 164
 Salsera rectangular 4 salsas, 165
 Salsera rectangular 6 salsas, 165
 Salseras de diseño 6 salsas, 165
 Salvamantel extensible, 169
 Santoku, 122
 Santoku de titanio, 124
 Santoku cerámico, 126
 Secamanos inox con pulsador y tobera, 421
 Secamanos inox de bajo consumo, 422
 Secamanos óptico en ABS, 422
 Secamanos óptico en ABS sin tobera modelo Nube, 422
 Secamanos óptico inox satinado con tobera, 421
 Secamanos óptico inox satinado sin tobera, 421
 Secamanos ultrarápido, 423
 Separador de monedas y billetes, 461
 Separador para mesa de marisco, 335
 Separador para mostrador de frutería / pescadería, 339, 341
 Separadores centrales, 41
 Separadores de esquina, 41
 Separadores para taquillas, 350
 Serrucho acero inoxidable, 93
 Set colgador sujeta-palos, 473
 Set de 4 flaneras de ø8 cm, 144
 Set de cepillo y soporte inoxidable para baño, 411
 Set de decoración, 130
 Set para corte de jamón, 109
 Sifón de desagüe (fregaderos ancho 500 mm, lavamanos, gran capacidad), 235
 Sifón de desagüe para lavamanos 1 1/2", 200

Repuesto roldana para abrelatas industrial 440021, 144
 Repuestos fregaderos, 234, 235
 Repuestos para aplasta hamburguesas, 95
 Repuestos para carros de servicio y recogida, 321
 Repuestos para contenedor de reciclaje vertical, 392
 Repuestos para contenedores inoxidables, 393
 Repuestos para esterilizadores, 375
 Repuestos para exterminadores de insectos, 383, 384
 Repuestos para grifos, 274
 Repuestos para mostradores de pescadería, 332
 Repuestos para purificador de aire, 366
 Repuestos para serruchos, 93
 Repuestos y accesorios para lavamanos, 198, 199, 200
 Repuestos y complementos para mobiliario, 351
 Repuestos y complementos para complementos, 489
 Resistencia, 375
 Resistencia de carga por estante, 12
 Rizador de mantequilla, 128
 Rociador de ducha, 272
 Rodillo, 84
 Rollo 2.000 tickets su-turno, 477
 Rollo de 2m de bayeta posavasos antideslizante multiusos, 234, 460
 Rueda anticalórica con freno en acero inoxidable ø100 mm, 324, 496
 Rueda anticalórica con freno en acero inoxidable ø100 mm., 321
 Rueda anticalórica en acero inoxidable ø100 mm., 321
 Rueda anticalórica en acero inoxidable ø100 mm, 324, 496
 Rueda de plástico ø50x18 mm para lavamanos autónomo, 201
 Rueda de repuesto para taburetes., 19, 480
 Rueda galvanizada con freno de diámetro 125 mm., 321
 Rueda galvanizada sin freno de diámetro 125 mm., 321
 Rueda repuesto para contenedores inox, 393
 Ruedas, 496
 Ruedas acopladas, 106, 497

Sifón de latón cromado, 235
 Sifón de latón cromado 1 1/2", 201
 Sifón de PVC acabado cromado, 235
 Sifón de PVC acabado cromado 1 1/2", 201
 Sistema filtrador de agua, 212
 Sistema filtrador de agua con caño, 213
 Sistema filtrador de agua con grifo llenajarras, 213
 Soporte de sobremesa o mural para botella de gel hidroalcohólico, 415
 Soporte de sobremesa y mural porta-cubetas Gastro-norm, 13
 Soporte dispensador de bolsas de paraguas, 472
 Soporte imagine, 28
 Soporte imagine a pared, 28
 Soporte inox para tacos o burritos, 164
 Soporte jamón RT, 60, 103
 Soporte organizador de acero inoxidable para 3 salsas, 150
 Soporte para cafeteras, 464
 Soporte para manguera en acero inoxidable, 265
 Soporte para tapa de cubeta Gastronorm, 445
 Soporte piña modelo apoyar, 275
 Soporte sobre-mostrador para balanzas, 465
 Soporte sobre-mostrador para cortadoras de fiambre, 297
 Soportes de estantería, 10
 Soportes de suelo, 58
 Soportes murales para pletina, 51
 Soportes murales para tubo, 50
 Spout for connecting to one handle mounted valve, 276
 Spray de acero inoxidable, 500
 Sujeciones de hierro para tirante, 56
 Sumidero para canal modular ranurado de salida vertical convertible a horizontal 200x200 mm., 240
 Sumidero sifónico con cestillo salida horizontal en acero inoxidable, 239
 Sumidero sifónico con cestillo salida vertical en acero inoxidable, 238

T

- T mezcladora M-H-M de 1/2", 202
- Tabla de corte alta precisión, 76
- Tabla de corte/pala de fibra, 83
- Taburete con ruedas, 19, 480
- Taburete inox regulable en altura, 479
- Taburete rodante profesional en acero inoxidable, 19, 479
- Taco galvanizado para techo tipo balancín, 64
- Taco regulable, 74, 351, 489
- Taco regulable altura especial, 351, 489
- Taco regulable altura especial para tubo, 498
- Taco regulable para soporte de estantería, 498
- Tacos de plástico nylon, 63
- Tacos de plástico para tubo, 499
- Tacos regulables para tubo, 498
- Tajo con sistema de elevación, 72
- Tajo de troceo de fibra serie GE, 70
- Tajo especial barbacoa, 70
- Tajo-expositor para mostrador de pescadería, 79, 331, 336
- Tajos de troceo de fibra con faldón, 69
- Tajos de troceo de fibra lastrados, 69
- Tajos de troceo madera con faldón, 71
- Tajos de troceo madera y fibra con faldón, 71
- Taladro, 151
- Tamizador en acero inox, 160
- Tapa, 410
- Tapa antidesbordamiento inox para cubeta GN gastro-norm, 437
- Tapa hermética GN de copoliéster BPA-Free, 439
- Tapa hermética GN de polipropileno BPA-Free, 443
- Tapa juntas de unión para mesas y fregaderos, 317
- Tapa para aro de tolva de desbarasado, 500
- Tapa para barreños, 408
- Tapa para caja alimentaria apilable, 457
- Tapa para carro de manutención 481070, 322
- Tapa para cestas de lavavajillas, 459
- Tapa para cubertero plástico gris GN 1/1, 461
- Tapa para cubetas GN para identificación de alérgenos, 441
- Tapa soporte para cubos y ollas., 231
- Tapajuntas de acero inoxidable, 487
- Tapas de polipropileno GN de colores, 444
- Tapas para cubetas Gastronorm, 436
- Tapas para cubetas Gastronorm alta temperatura, 440
- Tapas para cubetas Gastronorm copoliéster, 439
- Tapas para recipientes de polipropileno, 442
- Tapón cava cromado, 172
- Tapón cobre agujeros Ø42mm, 201
- Tapón de corona acero inox, 171
- Tapón fregaderos, para válvulas de Ø 49 mm serie 600 y 700, 235
- Tapón hermético acero inox (2 uds.), 171
- Tapón inox, 171
- Tapón inox cobre-agujeros (diámetro 42 mm), 235
- Tapón vertedor inox (2 ud), 171
- Taquilla - Consigna, 488
- Taquillas de 1, 2 y 3 puertas, 348
- Taquillas de 2, 4 y 6 puertas, 349
- Taza turca inox, 410
- Temporizador digital de cocina, 364
- Tenazas quita espinas, 168
- Tendedor retráctil, 412
- Tenedor de mesa, 167
- Tenedor de trinchar, 127
- Tenedor marisco, 169
- Tenedor trinchar EC, 128
- Tensor inox de repuesto, 93
- Tensor para guantes malla, 354
- Termo, 175
- Termómetro barbacoa bluetooth con 6 sondas, 361
- Termómetro compacto, 362
- Termómetro con sonda larga, 363
- Termómetro con sonda para atornillar, 362
- Termómetro digital básico, 360
- Termómetro digital con sonda para frigorífico-congelador, 360
- Termómetro digital de acero inoxidable para horno, 360
- Termómetro digital para botella de vino, 173
- Termómetro digital pistola de infrarrojos, 362
- Termómetro digital resistente al agua, 360
- Termómetro electrónico de sonda, 361
- Termómetro infrarrojo con adaptador para columna, 417
- Termómetro infrarrojo mural, 365
- Termómetro infrarrojo para personas, 365
- Termómetro para barbacoa, 362
- Termómetro para horno con selección de programas wireless, 361
- Termómetro para lavavajillas, 364
- Termómetro pistola con sonda, 363
- Tijera desmontable multiusos, 132
- Tijera pescadero / cocina con protección, 132
- Tijera profesional, 132
- Tijeras de trinchar, 132
- Tijeras multiusos, 132
- Tijeras pescadero, 132
- Tirador para puerta abatible, 351
- Tirafondos cabeza hexagonal, 63
- Tirante a pared para grifo ducha 463052, 275
- Tirante para balanzas regulable, 57
- Tirante para colgar balanzas, 57
- Tirante, soporte a pared para grifo ducha + soporte piña, 275
- Tirantes de techo, 53
- Tirantes de techo con varilla roscada, 53
- Tirantes de techo para tubo, 54
- Tirantes de techo para tubo con varilla roscada, 55
- Tirantes para balanzas, 58
- Toallero, 411
- Tochos de hierro cincado rosca métrica, 50
- Tolva abatible para posos de café, 495
- Tolva evacuación de desperdicios para adosar a tajos de troceo, 74, 465
- Tomate, 130
- Tope de muelle para grifo ducha, 275
- Tope para fibras, 79
- Tornillo allen M6x12 (tope de muelle y tirante a pared), 275
- Tornillo allen M6x8 (Soporte piña), 275
- Tornillo cabeza allen rosca métrica, 63
- Tornillo cabeza mariposa tipo americano, 64
- Tornillo pasante con tuerca y contratuerca rosca métrica, 64
- Tornillos barraqueros con embellecedor, 63
- Tornillos cabeza hexagonal rosca métrica, 62
- Tornillos rosca chapa, 63
- Tornillos y tuercas para estantes, 11
- Tramo para canal modular o canalina, 240
- Trampa inox para grasas de 20 lts., 237
- Trampa inox para grasas de 35 lts., 237
- Trampas adhesivas, 384
- Trampas adhesivas para MR-40 (460x175 mm.), 384
- Trampas adhesivas para MR-70, 384
- Trampas adhesivas para SP-80 (395x300 mm.), 384
- Trampas adhesivas para UL-80 (450x290 mm.), 384
- Trampas adhesivas para V-30, 384
- Transformador 4000 V. repuesto para exterminadores LED, 383
- Transformador repuesto para exterminador SP-80LED, 383
- Transpaleta de acero inoxidable, 483
- Transpaleta pintada, 483
- Triángulo, 86
- Trinchar forjado, 116
- Triturador de hielo, 148
- Tubo 11 W, 383
- Tubo 15 W, 383
- Tubo 18 W, 383
- Tubo 40 W, 383
- Tubo 8 W, 383
- Tubos en escuadra, 60
- Tubos en forma de " T ", 60
- Tubos pulidos, 43
- Tuerca ciega hexagonal con autoseguro, 65
- Tuerca de repuesto para caño giratorio 1/2", 278
- Tuerca hexagonal rosca métrica con autoseguro, 65

Tuerca mariposa tipo americano, 66
Tuerca unión mástil y válvula grifo ducha, 275

U

U en doble T, 61
U en forma de T, 61
U mixta en forma de T, 61
U sencilla, 61
Unión en escuadra exterior, 331, 340
Unión en escuadra interior, 341
Unión en escuadra interior para mostradores de pescadería, 331
Unión M-M de 1/2", 202

V

Vaciador doble, 129
Válvula de PVC con rebosadero, acabado cromado 1 1/2", 200
Válvula antiretorno H-H de 1/2", 202
Válvula con rebosadero (fregaderos serie 500 mm, lavamanos, cubetas semiesféricas y fregaderos de gran capacidad), 235
Válvula con rebosadero para lavamanos de 450x450 mm, 200
Válvula de desagüe Splus modelo doble, 236
Válvula de desagüe Splus modelo simple, 236
Válvula de descarga rápida, 235
Válvula de dos aguas, 278
Válvula de esfera H-H de 1/2", 202
Válvula de PVC con rebosadero, acabado cromado, 235
Válvula de un agua, 278
Válvula desagüe con cestillo, 235
Válvula desagüe de 1 1/2" para marmita, 257
Válvula desagüe de 1" para marmita, 257
Válvula desagüe de 2" para marmita, 257
Válvula doble entrada, dos aguas 1/4 vuelta, 277
Válvula doble entrada, dos aguas, monomando codo, 277

W

WC inox, 410

Z

Zócalo curvo de acero inoxidable, 487
Zócalo de acero inoxidable, 487

Tuercas ciegas hexagonales rosca métrica, 65
Tuercas hexagonales rosca métrica, 65

Universal dentado, 117
Urinario inox, 195
Urinarios inox, 409
Útil de centrado para corte de fruta, 82
Útil de montaje imagine, 31
Útil para picadora, 85
Útil para sujeción de jamones, 60, 103
Utilitario, 126

Válvula dos aguas con levas 1/4 de vuelta, 277
Válvula mezcladora antiretorno M-H-M de 1/2", 262
Válvula mezcladora termostática H-H-M de 1/2", 261
Válvula mezcladora termostática M-H-M de 1/2", 202
Válvulas monomando dos aguas, 277
Válvula monomando mural de codo monoblock para grifo ducha, 277
Válvula mural dos aguas con levas 1/4 de vuelta, 277
Válvula mural monomando dos aguas, 277
Válvula sin rebosadero (fregaderos serie 500 mm), 235
Válvula sin rebosadero Ø 49 mm (fregaderos serie 500, 600 y 700 mm), 235
Varillas roscadas rosca métrica, 64
Vaso en policarbonato, 167
Verduras, 124
Visor su turno con mando, 477
Vitrina bollería, 467
Vitrina bollería doble piso, 468
Vitrina cobre aperitivos, 467
Volteadora inox de tortilla, 142





CONDICIONES GENERALES

GENERAL CONDITIONS
CONDITIONS GÉNÉRALES

3.0
3.1, 3.2, 3.3

8.0
8.1, 8.2, 8.3, 8.4, 8.5

7.0
7.1, 7.2

6.0
6.1, 6.2, 6.3, 6.4, 6.5

11.0
11.1, 11.2

10.0
10.1, 10.2, 10.3, 10.4,
10.5

1.0 Ofertas de mercancías

- 1.1 • Todos los productos incluidos en el presente catálogo están amparados por la Normativa vigente en materia de verificación y calidad exigidas por la Normativa Estatal y Europea, dentro del ámbito de la actividad empresarial de Fricosmos, S.A.
- 1.2 • El ámbito de aplicación de las presentes condiciones generales de venta abarca toda la gama de productos que Fricosmos, S.A. ha referenciado en el presente catálogo.
- 1.3 • El comprador realizará los pedidos en los términos y condiciones expresamente publicados por Fricosmos, S.A. en su página web www.fricosmos.com. El presente catálogo puede quedar obsoleto en cualquier momento, por lo que los precios vigentes serán aquellos mostrados en la página web.
- 1.4 • Fricosmos, S.A. reserva el derecho de modificar los artículos incluidos en catálogo en función de las necesidades de la producción o de la existencia en el mercado de la materia prima para su fabricación. Por este motivo las imágenes no son contractuales.

2.0 Pedidos y presupuesto

- 2.1 • Los pedidos podrán efectuarse de forma verbal o por escrito, favoreciendo siempre la posibilidad de comprar a través de los servicios comerciales de Fricosmos, S.A.
- 2.2 • Una vez verificado el alta del cliente por parte de Fricosmos, S.A., se expedirá la oportuna carta de condiciones en la que se detallarán las condiciones comerciales que regirán desde ese momento entre ambas partes.
- 2.3 • El pedido queda condicionado a la aceptación definitiva por parte de Fricosmos, S. A.
- 2.4 • Todos los pedidos cuya fabricación requiera una medida especial o unas características concretas por requerimiento expreso del cliente, este vendrá obligado a garantizar el 50% del precio por adelantado. Además, este tipo de pedido no podrá ser cancelado por el cliente una vez formalizado, quedando en cualquier caso obligado al pago del 100% del pedido.
- 2.5 • La falta de pago por parte del comprador dará derecho a Fricosmos, S.A. a resolver el contrato en los términos expresamente establecidos en el artículo 1.124 del Código Civil.

3.0 Plazos de entrega

- 3.1 • Quedando supeditada la mercancía incluida en el presente catálogo a un proceso de fabricación del producto solicitado por el comprador, el plazo de entrega facilitado por Fricosmos, S.A. tendrá el carácter de orientativo o aproximado en el tiempo, por lo que en ningún momento el plazo indicado por nuestros agentes o por nuestra página web se podrá considerar de carácter contractual.
- 3.2 • Fricosmos, S.A. informará puntualmente al comprador del estado de elaboración de su pedido en la cadena de producción para evitar la demora del consecuente perjuicio del cliente.
- 3.3 • Los eventuales retrasos en la entrega no podrán dar lugar a penalización alguna o indemnización por daños y perjuicios, ni facultarán al comprador para anular el pedido, siempre que sea por causa imputable al proceso de fabricación.

4.0 Transporte de la mercancía

- 4.1 • La mercancía viajará siempre a portes debidos salvo pacto suscrito de forma expresa con cada uno de los clientes, que quedarán debidamente reflejados en la carta de condiciones que será expedida a tales efectos.
- 4.2 • Cuando la mercancía viaje a portes debidos por indicación expresa del cliente o por que así esté pactado en la carta de condiciones, Fricosmos, S.A. queda exonerado de las posibles taras o defectos que pudieran ser imputables al transporte de la mercancía.
- 4.3 • Cuando la mercancía viaje a portes pagados por Fricosmos, S.A., el cliente tiene que notificarle a Fricosmos, S.A. por escrito dentro de las 24 horas siguientes a la recepción de la mercancía, cualquier defecto o tara imputable a la agencia de transportes para facilitar la reclamación de la responsabilidad de acuerdo a la Ley 16/1.987 de Ordenación de los Transportes Terrestres y RD 1.111/1.990 por el que se aprueba el reglamento de la LOTT.
- 4.4 • No será admitida ninguna devolución de mercancía cuya tara o defecto sea imputable a la agencia de transporte, excepto que el cliente cumpla el siguiente requisito:
Que se lo notifique a Fricosmos, S.A. y/o a la Agencia de Transportes dentro de las 24 horas siguientes a la recepción de la mercancía o en el plazo legalmente establecido en cada momento en la Ley de Ordenación de Transportes Terrestres.
- 4.5 • La reclamación contra el porteador por daño o avería, deberá hacerse en el acto del recibo de los bultos siempre que se trate de daños aparentes y dentro de las 24 horas siguientes al recibo, si los daños fuesen no aparentes. La protesta o reserva debe hacerse por escrito.

5.0 Entrega de mercancías

- 5.1 • La relación contractual quedará perfeccionada cuando Fricosmos, S.A. entregue la mercancía al comprador a través del medio de transporte pactado en la carta de condiciones y el comprador firme previa revisión de la mercancía, el albarán o nota de entrega.
- 5.2 • Rehusando el comprador s in causa justa, el recibo de los bienes comprados, Fricosmos, S. A. podrá pedir el cumplimiento o la rescisión del contrato, siendo los gastos originados de cuenta de quien hubiere dado motivo para constituirlo.

6.0 Precios y forma de pago

- 6.1 • Los precios de los productos ofertados por FRICOSMOS, S.A. dentro del ámbito de su actividad empresarial, son los contenidos en la tarifa vigente publicada en nuestra página web www.fricosmos.com.
- 6.2 • Los precios contenidos en el catálogo no incluyen impuestos directos o indirectos, ni tasas o aranceles de naturaleza alguna.
- 6.3 • FRICOSMOS, S.A. hará constar el precio de la mercancía vendida en el presupuesto ofertado al cliente y en la factura que relaciona los productos vendidos de acuerdo con las tarifas vigentes.
- 6.4 • FRICOSMOS, S.A. y el cliente-comprador establecerán las formas de pago de las mercancías adquiridas en la carta de condiciones, y en su defecto, el precio será abonado en su integridad una vez puestas las mercancías a disposición del comprador.
- 6.5 • FRICOSMOS, S.A., se reserva el derecho a rectificar las erratas o errores materiales de que pudiera adolecer las presentes condiciones generales de venta.

7.0 Falta de pago

- 7.1 • Todos los retrasos en el pago del precio sobre el plazo estipulado, generarán el interés legal del dinero incrementado en 2 puntos mensualmente, y en el concepto de pena convencional.
- 7.2 • Todos los gastos que se originen, tanto judiciales como extrajudiciales, incluyendo los gastos bancarios, notariales, de abogados, de procuradores, etc., por el impago de recibos, letras de cambio, pagarés, cheques, etc., se pagarán por la parte compradora.

8.0 Garantía de los productos fabricados por fricosmos, S.A.

- 8.1 • Todos los productos incluidos en nuestro catálogo, gozan de una garantía de DOS AÑOS contado a partir de la fecha de entrega de la mercancía.
 - 8.1.1 • Los productos fabricados por Fricosmos, S.A. que pudieran adolecer de algún defecto de fabricación, serán reparados o sustituidos por otro de iguales características, siempre que por parte del cliente se cumplan en debida forma los requisitos que con toda claridad y precisión se detallan a continuación:
 - 1| Que el cliente avise por escrito a Fricosmos, S.A. de la existencia de un posible defecto.
 - 2| Que la pieza que tiene que ser sustituida sea enviada a la sede de nuestra empresa para su oportuna revisión.
 - 3| Que el cliente abone los portes de ida y vuelta de la pieza que tiene que ser susceptible de reposición o reparación.
 - 4| El cliente goza de una garantía en todos los productos que adquiera, que despliega sus efectos dentro de la instalación comercial de FRICOSMOS, S.A. pero en ningún caso podrá asumirse en el exterior.
- 8.2 • Los servicios técnicos de Fricosmos, S.A. asumen la responsabilidad de examinar la pieza o mercancía remitida por el cliente para corroborar la existencia de un posible defecto de fabricación.
- 8.3 • Si del dictamen de la oficina técnica de Fricosmos, S.A. se determina la existencia de un defecto de fabricación, Fricosmos, S.A. vendrá obligado a sustituir o reparar la mercadería que fue comprada por el cliente, le será enviada al domicilio social que figure en el albarán originario sin coste alguno para el cliente excepto los portes.
- 8.4 • Las piezas o materiales serán siempre sustituidos por otros de iguales características o calidades.
- 8.5 • El cambio o la sustitución de las piezas defectuosas no incluyen ni la instalación ni la mano de obra que haya de ser realizada por terceras personas.
- 8.6 • El cliente tiene pleno derecho a recibir información técnica del dictamen emitido por el fabricante.
- 8.7 • Quedan excluidos de garantía los consumibles, como por ejemplo los tubos fluorescentes, bombillas, lámparas de ozono, etc.

9.0 Reclamaciones

Las posibles reclamaciones acerca del estado o cantidad de la mercancía, se efectuarán por escrito, enviando un email a nuestro *Departamento de Asistencia* (asistencia@fricosmos.com) en el plazo de 24h desde su recepción y de acuerdo a los puntos 4.3 y 4.4. Se deberá indicar a cada reclamación el número de albarán y en caso de tratarse de problemas físicos de la mercancía recibida, se adjuntarán imágenes y/o vídeos donde se muestren tales defectos.

10.0 Devolución de mercancías

- 10.1 • La devolución de material deberá ser autorizada por nuestro Departamento de Asistencia, que indicará al cliente el número de caso / autorización para gestionar la devolución. El material deberá devolverse referenciado con el nº de caso visible y notificado a la empresa de transporte. Sin esta información no se admitirá ningún tipo de mercancía en nuestro almacén.
- 10.2 • No se admitirá en ningún caso, la devolución de materiales usados, sin plástico protector, los probados o los encargados a medida.
- 10.3 • Todos los gastos de retorno de la mercancía a devolver, manipulación, embalajes y seguro, correrán por parte del comprador, siendo estos los encargados de reclamar los daños o pérdidas que se pudieran ocasionar.
- 10.4 • Fricosmos se reserva el derecho de admisión de la devolución hasta su inspección de calidad y cantidad de la mercancía en nuestras instalaciones de Móstoles.
- 10.5 • Toda devolución genera un *saldo a favor* del cliente, que será descontado en la siguiente o siguientes compras.

11.0 Reserva de dominio

- 11.1 • El vendedor se reserva el dominio de la mercancía vendida hasta el pago completo de todas las cantidades que el comprador le adeude.
- 11.2 • El vendedor se reserva el derecho de dar por rescindido el contrato si el comprador no cumpliera cualquiera de las condiciones Generales de Venta, reseñadas en virtud de ello, exigir los reintegros, garantías o indemnización de perjuicios que conviniera a sus intereses o hubiera lugar en derecho.

12.0 Legislación aplicable

La interposición de las presentes Condiciones de Venta se encuentra amparada en el Código Civil y en el Código de Comercio, así como en la Ley 7/1998 de 13 de Abril de Condiciones General de la Contratación y en la Ley 16/1987 de 30 de Julio de Ordenación de los Transportes Terrestres.

13.0 Jurisdicción

- 13.1 • El contrato de compraventa se entenderá siempre realizado en España, rigiéndose por la normativa legal Española en todo lo no previsto en las presentes condiciones generales de venta.
- 13.2 • Cualquier divergencia surgida como consecuencia del contrato de venta establecido, deberá ser resuelta ante los juzgados y tribunales de Móstoles (Madrid), a cuyo fuero se someten expresamente comprador y vendedor, renunciando de manera expresa al que pudiera corresponderles.
- 13.3 • Queda especialmente convenido que todos los giros impagados o los plazos vencidos serán reclamados, así como la acción ejecutiva que de ellos dimana, ante los juzgados o tribunales de Móstoles (Madrid) España, aunque sea otro el domicilio del aceptante o el lugar de pago indicado en las letras.

1.0 Merchandise offer

- 1.1 • Every product included in the current catalogue are according to the current rules as regards verification and quality required by the National and European Regulations, within Fricosmos' business context.
- 1.2 • All the range of products that Fricosmos, S.A. has indexed in the current catalogue are within the limits of application of the current General Conditions of Sale.
- 1.3 • The buyer will place the orders under the terms and conditions expressly published by Fricosmos, S.A. on its website www.fricosmos.com. This catalog may become obsolete at any time, so the current prices will be those shown on the website.
- 1.4 • Fricosmos, S.A. reserves the right to modify the articles included in the catalog according to the needs of production or the existence in the market of the raw material for their manufacture. For this reason, the images are not contractual.

2.0 Quotations and orders

- 2.1 • Orders will be effected verbally or in writing, favouring always the possibility of purchasing through the commercial service of Fricosmos, S.A.
- 2.2 • Once verified the registration of the customer by Fricosmos, S.A., the corresponding letter of conditions will be issued, detailing the commercial conditions that will rule in the future for both parties.
- 2.3 • The order will be subject to the definite acceptance of Fricosmos, S.A.
- 2.4 • All orders with bespoke items (whose fabrication requires any specific characteristics upon request of the buyer), will be obliged to secure 50% of the price in advance by the buyer. In addition, these kinds of orders are not subject to cancellation by the buyer once placed and will be still obliged to pay 100% of the order.
- 2.5 • The lack of payment by party of the purchaser will entitle Fricosmos, S.A. to dissolve the contract in the terms expressly established in the article 1124 of the Spanish Código Civil.

3.0 Delivery time

- 3.1 • As the merchandise included in this catalog is subject to a manufacturing process of the product requested by the buyer, the delivery time provided by Fricosmos, S.A. will be approximate or for guidance only, so that the period stated by our agents or by our website will not be considered contractual under any circumstance.
- 3.2 • Fricosmos, S.A. will inform reliably to the purchaser about the manufacturing progress of his order in the assembly line in order to avoid delaying a possible harm to the customer.
- 3.3 • The punctual delivery delay will not cause any penalty or compensation, nor entitle the purchaser to cancel the order, as long as it is due to the manufacturing process.

4.0 Merchandise transport

- 4.1 • The merchandise will ever be shipped ex works except agreement subscribed expressly with every customer, which will be duly reflected in the letter of conditions issued for this purpose.
- 4.2 • In case that the carriage of the merchandise is paid following the customer instructions or because is so stipulated in the letter of conditions, Fricosmos, S.A. will be exonerated of any possible defect or fault that could be attributed to the transport of the merchandise.
- 4.3 • In case that the carriage of the merchandise is paid by Fricosmos, S.A., the customer must notify Fricosmos, S.A. in writing and within 24 hours after the reception of the merchandise any defect or fault attributed to the shipping agent in order to make easier the responsibility claim in accordance to the regulation 16/1987 of the Spanish Ordenación de los Transportes Terrestres and the RD 1111/1990 by which the regulation of the LOTT is approved.
- 4.4 • No merchandise returns will be admitted if the defect or fault is attributed to shipping agent except in case that the customer complies the following requirement: That he notifies the incidence to Fricosmos, S.A. and/or to the shipping agent within 24 hours after the reception of the merchandise or within the period legally determined at the time of the shipment by the Spanish Ley de Ordenación de Transportes Terrestres.
- 4.5 • The claim against the shipping agent for defect or fault must be done at the reception of the goods whenever there are apparent damages and within 24 hours after their reception if they are non-apparent. The claim must be done in writing.

5.0 Delivery of the merchandise

- 5.1 • The contractual relationship will be completed once Fricosmos, S.A. delivers the merchandise to the buyer through the means of transport agreed in the letter of conditions and the buyer signs, after verification of the merchandise, the proof of delivery.
- 5.2 • If the purchaser rejects the reception of the sold goods without a just cause, Fricosmos, S.A. will be entitled to demand the expiration or cancellation of the contract, and the expenses will be charged on the account of the party that would have originated it.

6.0 Prices and way of payment

- 6.1 • The prices of the products offered by FRICOSMOS, S.A. within the scope of its business activity, are those contained in the existing price list published on our website www.fricosmos.com.
- 6.2 • The prices included in the catalogue does not include direct or indirect taxes, nor rates or duties.
- 6.3 • Fricosmos, S.A. will reflect the price of every merchandise sold in the offer quoted to the customer and in the invoice listing the sold products in accordance with the valid price-list.
- 6.4 • Fricosmos and the customer-purchaser will establish the means of payment for the acquired merchandises in the letter of conditions, and in default, the price will be fully charged once the merchandise at the purchaser disposition.
- 6.5 • Fricosmos, S.A. reserves the right to rectify the mistakes or material errors which could present the current general conditions of sale.

7.0 Arrears of payment

- 7.1 • All arrear in payment over the stipulated period will generate the legal currency interest increased in 2 points per month in concept of conventional penalty.
- 7.2 • All expenses originated in the failure of payment of accounts, bills of exchange, bonds, cheques, as much judicial as out-of-law, including expenses for bank, notary, lawyer, solicitor etc. will be charged to the purchaser party.

8.0 Warranty of the products manufactured by Fricosmos, S.A.

- 8.1 • All products included in our catalogue are guaranteed for TWO YEARS from the delivery date on.
 - 8.1.1 • The products manufactured by Fricosmos, S.A. that could have suffered any manufacture defect will be repaired or substituted by another of the same characteristics whenever the customer carries out all the requirements clearly detailed below:
 - 1| The customer must notify in writing to Fricosmos the existence of an eventual defect.
 - 2| The piece to be substituted must be shipped to our facilities for its corresponding inspection.
 - 3| The customer must pay the transport of the item to be repaired to and from our facilities.
 - 4| The customer can make effective his guarantee right on our products within Fricosmos facilities only. It will never be accepted outside them.
- 8.2 • Fricosmos Technical Service takes on the responsibility of inspecting the piece or merchandise received from the customer to corroborate the existence of a possible defect of manufacture.
- 8.3 • If the final report of the Technical Service of Fricosmos, S.A. determines the existence of a defect of manufacture, Fricosmos, S.A. will be obliged to substitute or repair the merchandise acquired by the customer, and it will be resent to the delivery note original address without any additional cost, except the transport.
- 8.4 • Pieces or materials will always be substituted by another of the same characteristics or quality.
- 8.5 • The change or substitution of the defect parts do not include neither installing or labour which must be done by a third party.
- 8.6 • The customer has full right to receive technical information about the report issued by the manufacturer.
- 8.7 • All the consumable products such as fluorescent tubes, bulbs, ozone lamps, etc. are excluded from this warranty.

9.0 Claims

Any eventual claim regarding the state or quantity of the merchandise shall be made in writing, by sending an email to our *Assistance Department* (assistance@fricosmos.com) within 24 hours from the delivery and in accordance with points 4.3 and 4.4. The delivery note number must be stated to each claim and in case of visible defects or damages of the merchandise received, images and / or videos showing them will be attached.

10.0 Returns of merchandise

- 10.1 • The return of material must be authorized by our Assistance Department, who will provide to the buyer a case / authorization number to manage the return. The case number must be visible on the returned packages and notified to the transport company. No returns of merchandise will be accepted in our warehouse without this information.
- 10.2 • Fricosmos, S.A. will not accept under any circumstance the return of used, tested, without protective plastic or custom-made material.
- 10.3 • The purchaser will take care of all costs of shipping, handling, packaging and insurance to return the goods and will be responsible for claiming any damage or loss that may result from this circumstance.
- 10.4 • Fricosmos reserves the right to refuse de admission of the returned goods until their inspection for quality and quantity in our facilities in Móstoles.
- 10.5 • Any return that generates a *balance in favor* of the customer will be deducted from the next or subsequent purchases.

11.0 Reserve of property

- 11.1 • The vendor reserves the right of ownership of the purchased goods until the full amount that is owed by the purchaser is paid.
- 11.2 • The vendor reserves the right to terminate the contract if the purchaser does not comply with all of the General Conditions of Sale mentioned. By virtue of this, Fricosmos, S.A. is entitled to demand the payment, warranties or compensation for damages suitable to their interests.

12.0 Applicable legislation

- 12.1 • The insertion of the current Sales conditions is in accordance with the Spanish Código Civil and the Código de Comercio, as well as with the regulations 7/1998 from 13th April on the Spanish Condiciones Generales de Contratación and 16/1987 from 30th July on the Ordenación de los Transportes Terrestres.

13.0 Jurisdiction

- 13.1 • The contract of sale is always understood to be executed in Spain and is governed by the legal norms of Spain in all aspects non covered by the current General Conditions of Sale.
- 13.2 • Any divergence arising as a consequence of an established contract of sale must be resolved by the Courts and Tribunals of Móstoles (Madrid), to whose jurisdiction both the purchaser and the vendor are expressly subjected, and renouncing expressly to any other which might correspond to them.13.3 It is expressly agreed that all unpaid accounts or installment payments due will be reclaimed, as well as the executive action arising from them, before the Courts and Tribunals of Móstoles (Madrid) España, even if the address of the acceptor is elsewhere or the place of payments indicated in correspondence is elsewhere.

1.0 Offre de marchandises

- 1.1 • Tous les produits inclus dans ce catalogue-ci sont soutenus par la réglementation en vigueur en affaire de vérification et qualité exigé par la loi de l'Etat Espagnol et l'Union Européenne, dans le cadre de l'activité commerciale de Fricosmos, S.A.
- 1.2 • Le cadre d'application de ces conditions générales de vente comprend toute la gamme des produits de ce catalogue.
- 1.3 • L'acheteur passera les commandes selon les termes et conditions expressément publiés par Fricosmos, S.A. sur son site internet www.fricosmos.com. Ce catalogue peut devenir obsolète à tout moment, les prix en vigueur seront donc ceux indiqués sur le site.
- 1.4 • Fricosmos, S.A. se réserve le droit de modifier les articles inclus dans le catalogue en fonction des besoins de production ou de l'existence sur le marché de la matière première pour leur fabrication. Pour cette raison les images ne sont pas contractuelles.

2.0 Commandes et offres

- 2.1 • Les commandes pourront s'effectuer de façon verbale ou écrite, tout en favorisant la possibilité d'acheter à travers de tous les services commerciaux de Fricosmos, S.A.
- 2.2 • Une fois l'inscription du client soit vérifiée par Fricosmos, S.A., on expédiera la lettre de conditions opportune dans laquelle on détaillera les conditions commerciales qui régiront dès ce moment entre les deux parties.
- 2.3 • La commande est conditionnée à l'acceptation définitive par Fricosmos, S.A.
- 2.4 • Toutes commandes dont la fabrication nécessite une mesure particulière ou des caractéristiques particulières à la demande exprès du client, ce dernier sera tenu de garantir 50% du prix d'avance. De plus, ce type de commande ne peut être annulé par le client une fois celle-ci formalisée, étant en tout état de cause tenu de payer 100% de la commande.

3.0 Délais de livraison

- 3.1 • La marchandise figurant dans ce catalogue étant soumise à un procédé de fabrication du produit demandé par l'acheteur, le délai de livraison prévu par Fricosmos, S.A. Il sera à titre d'orientation ou approximatif dans le temps, de sorte qu'à aucun moment le délai indiqué par nos agents ou par notre site internet ne pourra être considéré comme contractuel.
- 3.2 • Fricosmos, S.A. informera à l'acheteur ponctuellement de l'état d'élaboration de sa commande dans la chaîne de production pour éviter le retard et le conséquent préjudice au client.
- 3.3 • Les retards de livraison éventuels ne pourront pas donner lieu à aucune sanction ou indemnisation par dommages et intérêts. Ils n'autoriseront pas non plus à annuler la commande, quand le retard soit imputable au procès de fabrication.

4.0 Transport de la marchandise

- 4.1 • La marchandise voyagera toujours à ports dus sauf accord suscrit expressément avec chacun des clients, ce qui restera dûment exprimé dans la lettre de conditions qui sera expédiée au client.
- 4.2 • Quand la marchandise voyage à ports dus par désir exprès du client ou parce que dans la lettre de conditions on a fait ce pacte, Fricosmos, S.A. est exonéré des possibles tares ou défauts qui pourront être imputables au transport de la marchandise.
- 4.3 • Quand la marchandise voyage à ports payés par Fricosmos, S.A., le client doit notifier à Fricosmos, S.A. par écrit dans les 24 heures suivantes à la réception de la marchandise de n'importe quel défaut ou tare imputable à la compagnie de transports pour faciliter la réclamation de la responsabilité dans le cadre de la loi espagnole 16/1.987 d'Ordonnances des Transports Terrestres et Royal Décret espagnol 1.111/1.990 par lequel s'approuve le règlement de la LOTT (loi d'Ordonnances des Transports Terrestres).
- 4.4 • On n'admettra pas dévolution de marchandise avec une tare ou un défaut imputable à la compagnie de transport, sauf que le client accomplisse la condition suivante : Notifier à Fricosmos, S.A. et / ou à l'agence de transport dans les 24 heures suivantes à la réception de la marchandise ou dans le délai établi légalement à chaque moment dans la Loi d'Ordonnances des Transports Terrestres espagnole.
- 4.5 • La réclamation contre la compagnie de transport par dommage ou panne, devra se faire à la réception des colis quand il s'agit de dommages apparents et dans les 24 heures suivantes à la réception si les dommages ne sont pas apparents. La plainte ou réserve doit se faire par écrit.

5.0 Remise de marchandises

- 5.1 • La relation contractuelle sera parfaite lorsque Fricosmos, S.A. livrera la marchandise à l'acheteur par le moyen de transport convenu dans le cahier des charges et l'acheteur signe après avoir pris connaissance de la marchandise, le bon de livraison ou la note de bon de livraison.
- 5.2 • Dans le cas où l'acheteur refuse la marchandise sans une cause juste à la réception des biens achetés, Fricosmos, S.A. pourra demander l'accomplissement ou la résiliation du contrat. Les frais dérivés seront à la charge de la personne qui ait donné le motif pour les constituer.

6.0 Prix et mode de paiement

- 6.1 • Les prix des produits proposés par FRICOSMOS, S.A. Dans le cadre de son activité, il s'agit du contenu du tarif en vigueur publié sur notre site internet www.fricosmos.com.
- 6.2 • Les prix contenus dans le catalogue n'incluent pas des impôts directs ou indirects, ni des taxes ni des tarifs douaniers d'aucune nature.
- 6.3 • Fricosmos, S.A. fera figurer le prix de la marchandise vendue dans le devis offert au client et dans la facture qui réfléchira les produits vendus d'accord aux tarifs en vigueur.
- 6.4 • Fricosmos, S.A. et le client-acheteur établiront les façons de paiement des marchandises acquises dans la lettre de conditions, et à défaut de cette lettre, le prix sera payé intégralement une fois les marchandises sont mis à disposition de l'acheteur.
- 6.5 • Fricosmos, S.A. réserve le droit de rectifier les erratum ou les fautes matérielles qui pourront exister dans ces conditions générales de vente.

7.0 Manque de paiement

- 7.1 • Tous les retards dans le paiement du prix au-dessus du délai stipulé, généreront l'intérêt légal de l'argent augmenté deux points à chaque mois à titre de sanction conventionnelle.
- 7.2 • Tous les frais qui se génèrent, soit judiciaires, soit extra judiciaires, tout en incluant les frais bancaires, notariaux, d'avocats, de huissiers etc. par la manque de paiement de reçus, lettres de change, traites, chèques, billets à l'ordre etc. seront payés par la part acheteuse.

8.0 Garantie des produits fabriqués par Fricosmos, S.A.

- 8.1 • Tous les produits inclus dans ce catalogue ont une garantie DEUX ANS à partir de la date de remise de la marchandise.
 - 8.1.1 • Les produits fabriqués par Fricosmos, S.A. qui pourront avoir quelque défaut de fabrication seront réparés ou substitués par un autre des mêmes caractéristiques, pourvu que le client aie accompli les conditions qui avec précision sont détaillés ci-dessous:
 - 1| Que le client notifie par écrit à Fricosmos, S.A. de l'existence d'un éventuel défaut.
 - 2| Que la pièce à substituer soit envoyé à l'adresse de notre société pour une révision.
 - 3| Que le client paie le transport d'aller et de retour de la pièce qui va se réviser ou réparer.
 - 4| Le client a une garantie dans tous les produits qu'il achète qui n'est valable que dans l'installation commerciale de Fricosmos, S.A. Fricosmos, S.A. ne pourra pas assumer une garantie à l'extérieur des installations de Fricosmos, S.A.
- 8.2 • Les services techniques de Fricosmos, S.A. assument la responsabilité d'examiner la pièce ou marchandise envoyé par le client pour corroborer l'existence d'un éventuel défaut de fabrication.
- 8.3 • Si le rapport des techniciens de Fricosmos, S.A. détermine l'existence d'un défaut de fabrication, Fricosmos, S.A. sera obligé de substituer ou réparer la marchandise achetée par le client, et elle sera envoyée à l'adresse du bon de livraison original sans coût additionnel pour le client, sauf le transport.
- 8.4 • Les pièces ou matériaux seront toujours substitués par des autres avec les mêmes caractéristiques ou qualités.
- 8.5 • Le changement ou substitution des pièces avec des défauts n'inclut pas l'installation ni la main d'œuvre de troisièmes parties.
- 8.6 • Le client a plein droit à recevoir des renseignements techniques sur le rapport émis par le fabricant.
- 8.7 • Tous les produits consommables tels que les tubes fluorescents, ampoules, lampes d'ozone, etc sont exclus de cette garantie.

9.0 Réclamations

Les éventuelles réclamations concernant le statut ou la quantité de la marchandise seront formulées par écrit, en adressant un courrier électronique à notre *Service d'Assistance* (assistance@fricosmos.com) dans les 24 heures suivant la réception et conformément aux points 4.3 et 4.4. Le numéro du bon de livraison doit être indiqué pour chaque réclamation et en cas de problèmes physiques de la marchandise reçue, des images et/ou vidéos montrant de tels défauts seront jointes.

10.0 Dévolution de marchandises

- 10.1 • Le retour de matériel doit être autorisé par notre Service d'Assistance, qui indiquera au client le numéro de dossier/autorisation pour gérer le retour. Le matériel doit être retourné référencé avec le numéro de cas visible et notifié au transporteur. Sans ces informations, aucun type de marchandise ne sera accepté dans notre entrepôt.
- 10.2 • Fricosmos, S.A. n'admettra aucune dévolution de matériaux usagés, éprouvés ou commandés sur mesure.
- 10.3 • Tous les frais de transport, la manutention, l'emballage et l'assurance pour retourner la marchandise seront à la charge de l'acheteur, qui sera aussi responsable de réclamer tout dommage ou perte qui pourrait résulter de cette circonstance.
- 10.4 • Fricosmos se réserve le droit de refuser l'admission des marchandises retournées jusqu'à leur inspection de la qualité et la quantité dans nos installations à Móstoles.
- 10.5 • Tout retour génère un *solde en faveur* du client, qui sera décompté lors des achats suivants ou ultérieurs.

11.0 Réserve de propriété

- 11.1 • Le vendeur se réserve la propriété des marchandises vendues jusqu'au paiement complet de toutes les quantités dues par l'acheteur.
- 11.2 • Le vendeur se réserve le droit d'annuler le contrat si l'acheteur n'exécute pas une ou plusieurs des conditions générales de vente, ici signalées, d'exiger les remboursements, les garanties ou l'indemnisation des dommages qui conviennent à ses intérêts qu'il y ait lieu en droit.

12.0 Législation applicable

L'interposition de ces conditions de vente est encadrée dans le Code Civil, dans le Code de Commerce, dans la loi espagnole 7/1.998 du 13 avril de « Condiciones Generales de la Contratación » et dans la loi espagnole 16/1.987 de 30 juillet de Ordenación de los Transportes Terrestres

13.0 Jurisdiction

- 13.1 • Le contrat de vente sera entendu comme réalisé toujours en Espagne, s'y appliquant la normative légale espagnole en tout ce qui n'est pas prévu dans les présentes conditions générales de vente.
- 13.2 • Toute divergence qui puisse surgir comme conséquence du contrat de vente établi devra être solutionnée devant les tribunaux de Móstoles (Madrid) Espagne, auxquels se soumettent de forme expresse tant l'acheteur que le vendeur, renonçant expressément à ceux qui en fait pourrait leur correspondre.
- 13.3 • Il est surtout convenu que tous les virements non payés ou les délais échus seront demandés, ainsi que l'acte d'exécution qui en dérive, devant les tribunaux de Móstoles (Madrid) Espagne, même quand le domicile de l'acceptant ou l'endroit du paiement des lettres soit ailleurs.



www.FRICOSMOS.com

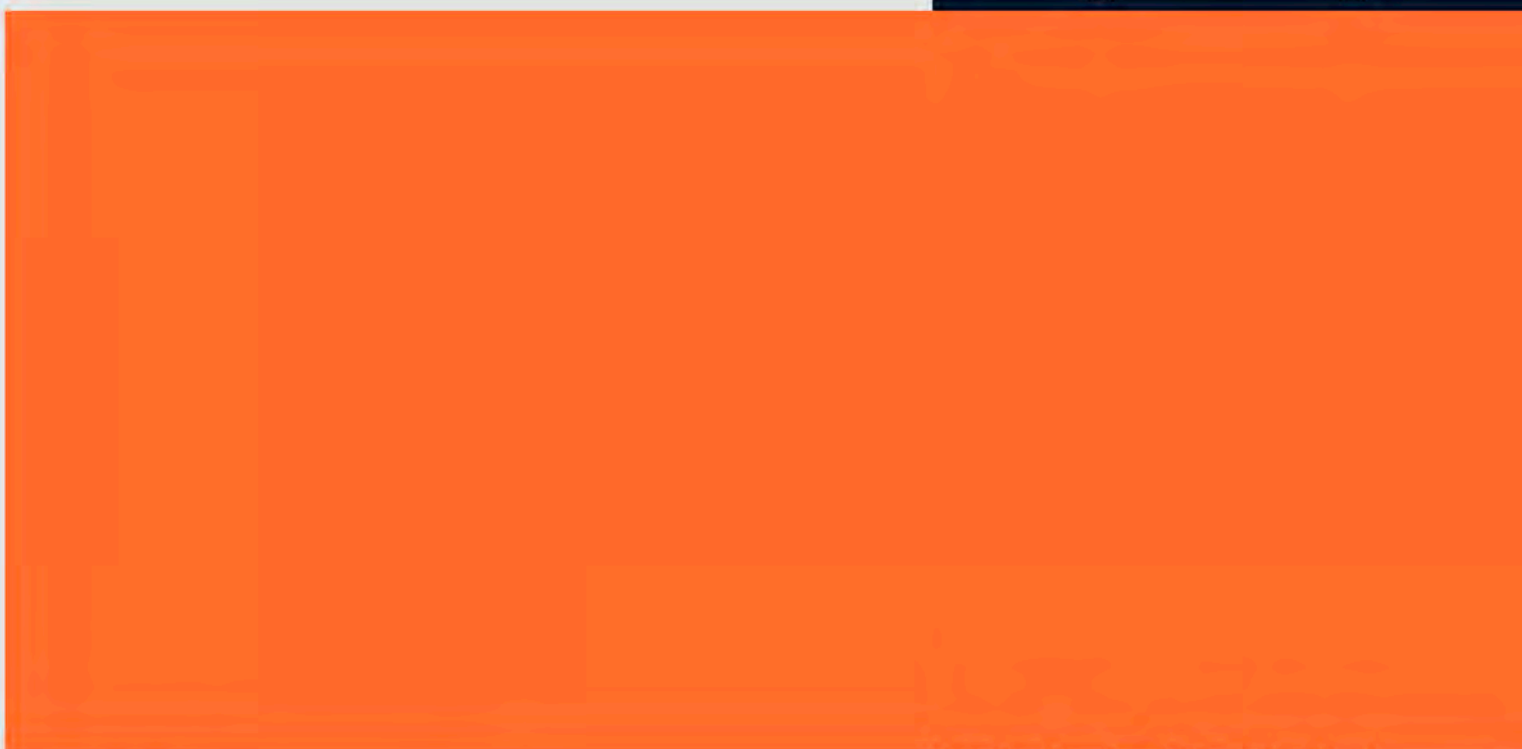
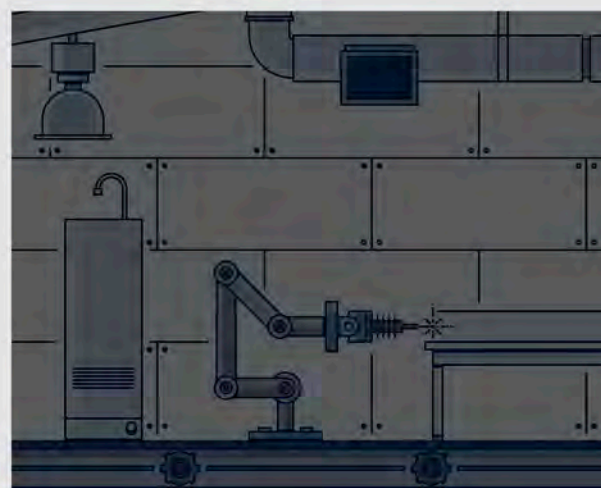

Fricosmos, S. A.
Polígono industrial nº 1
C/ Cámara de la Industria, 11A
28938 Móstoles (Madrid)
ESPAÑA
www.fricosmos.com

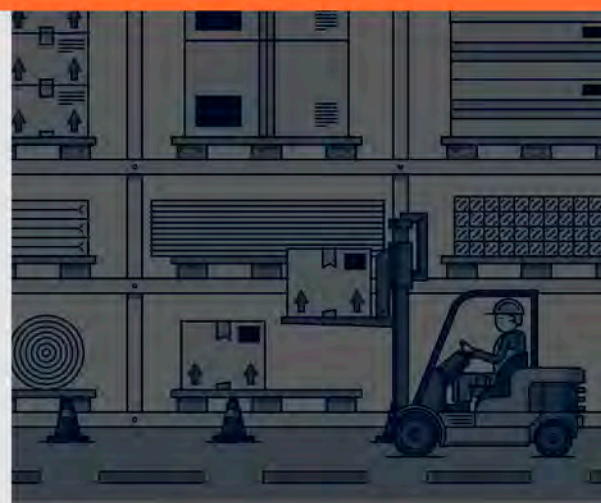

info@fricosmos.com